

A hand-drawn sketch of a wrestling arena. The floor is a grid of lines, with perspective lines leading towards a vanishing point in the distance. On the left and right sides, there are rough, jagged lines representing the arena's walls or audience seating. In the center, a dark rectangular box contains a digital timer. Below the timer, there is a line of text. The overall style is a simple, sketchy line drawing.

03:46:01

Time until AJ Jr brings The Smackdown™

03:46:00

Time until AI Co brings The Smackdown™

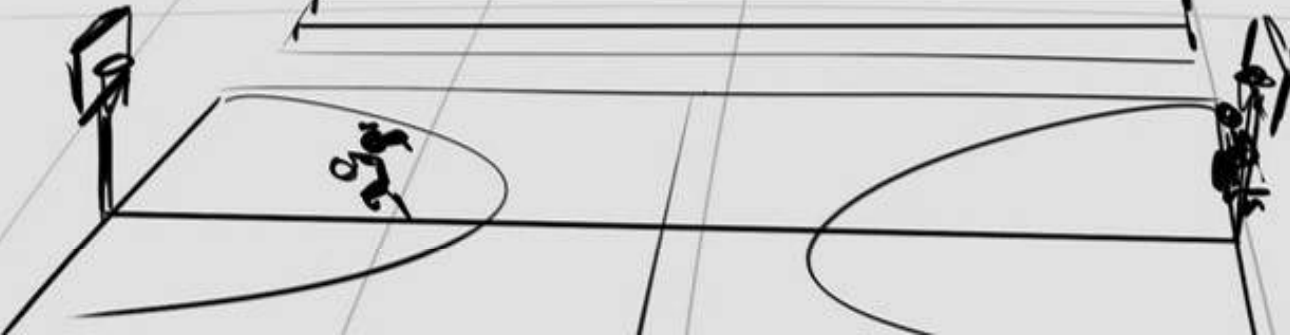
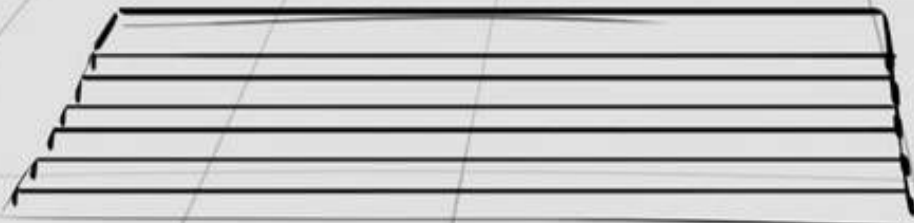
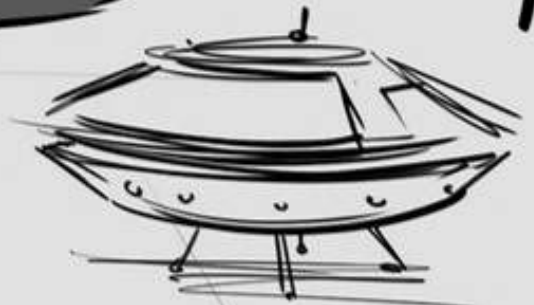

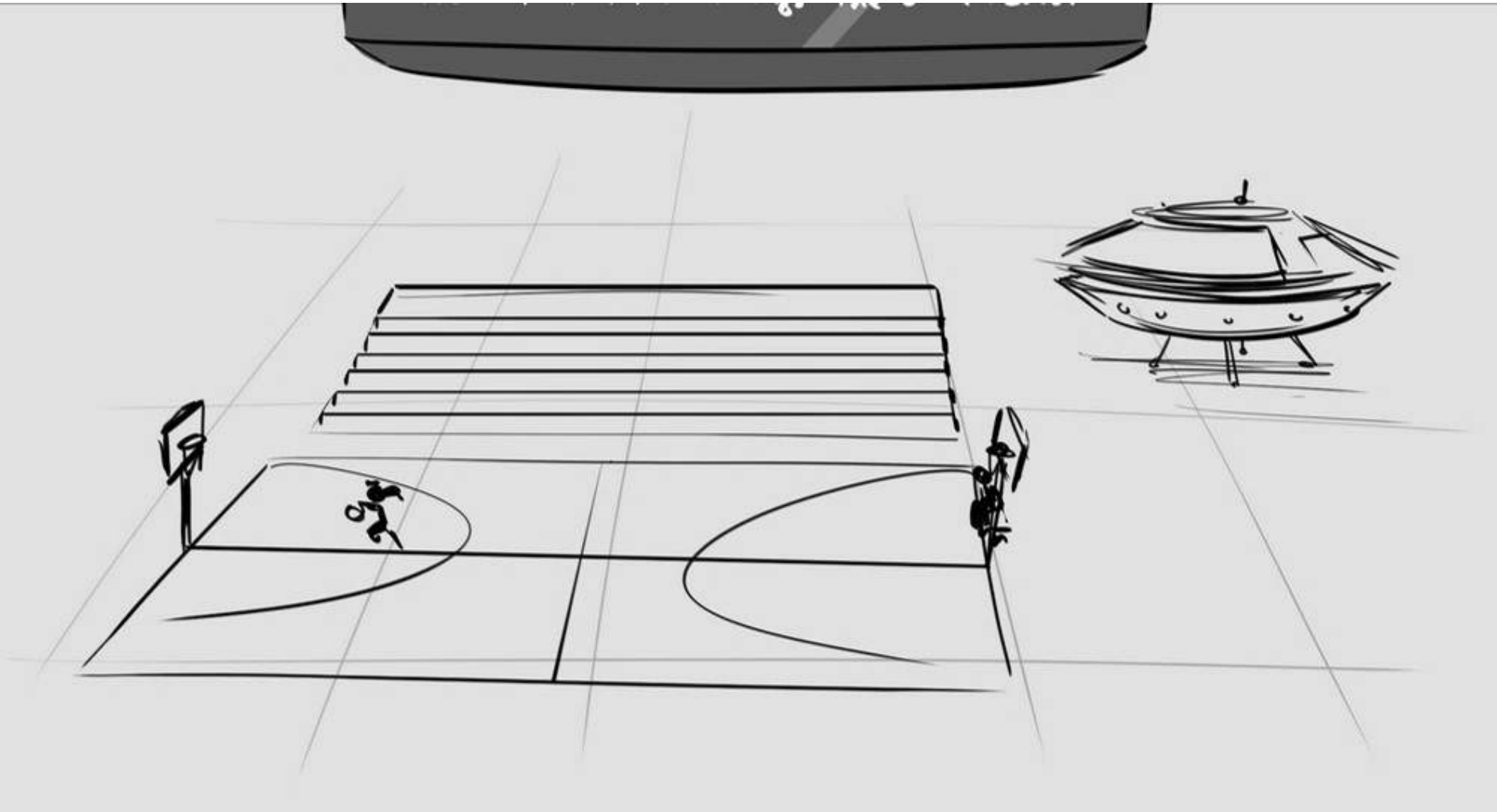

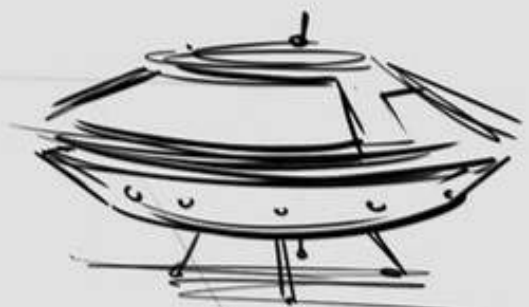
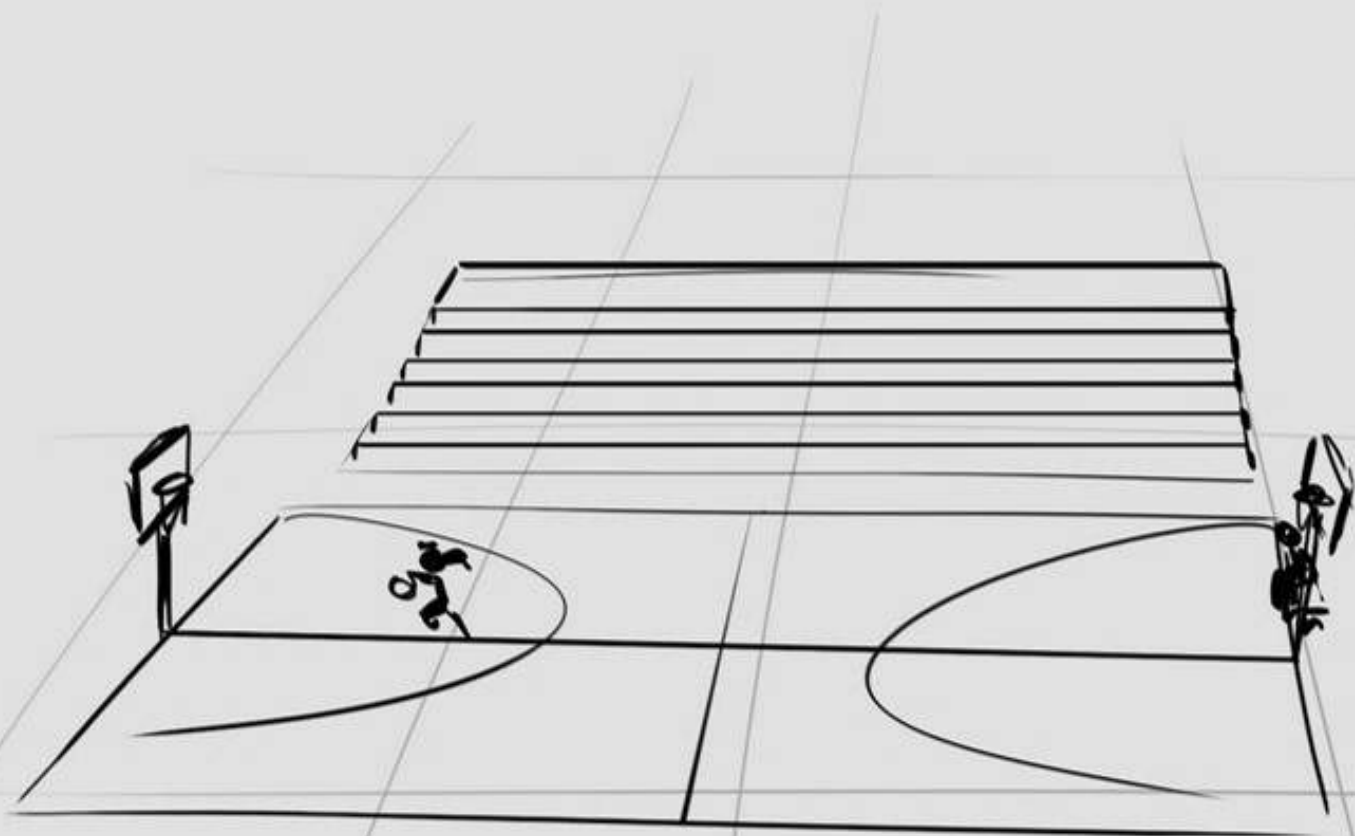

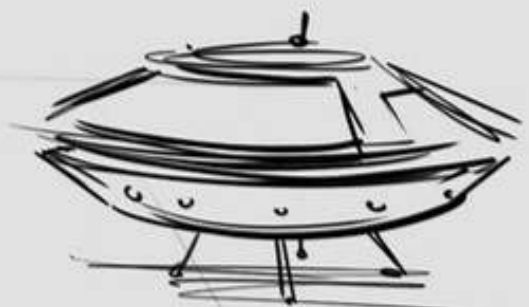
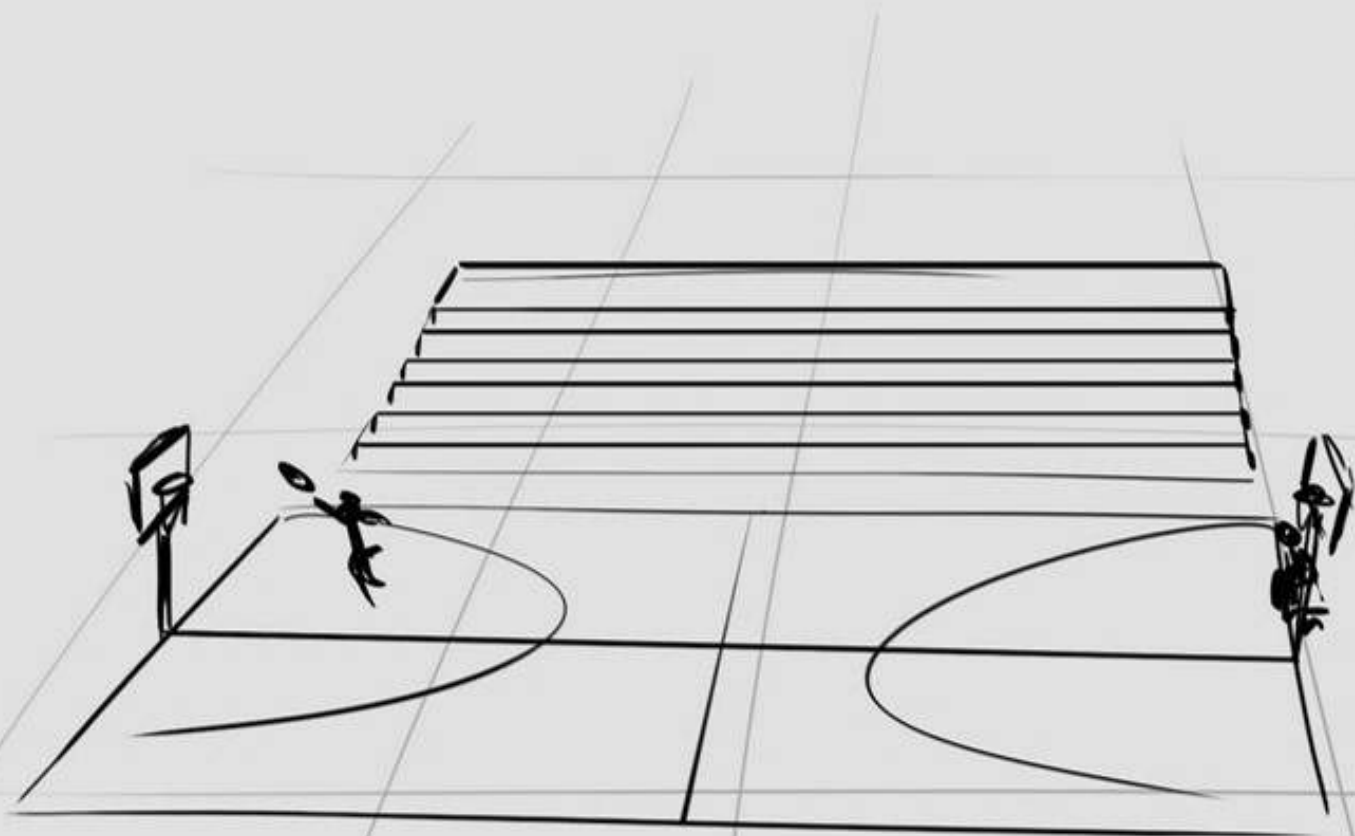



DAFFY: (snooooore)

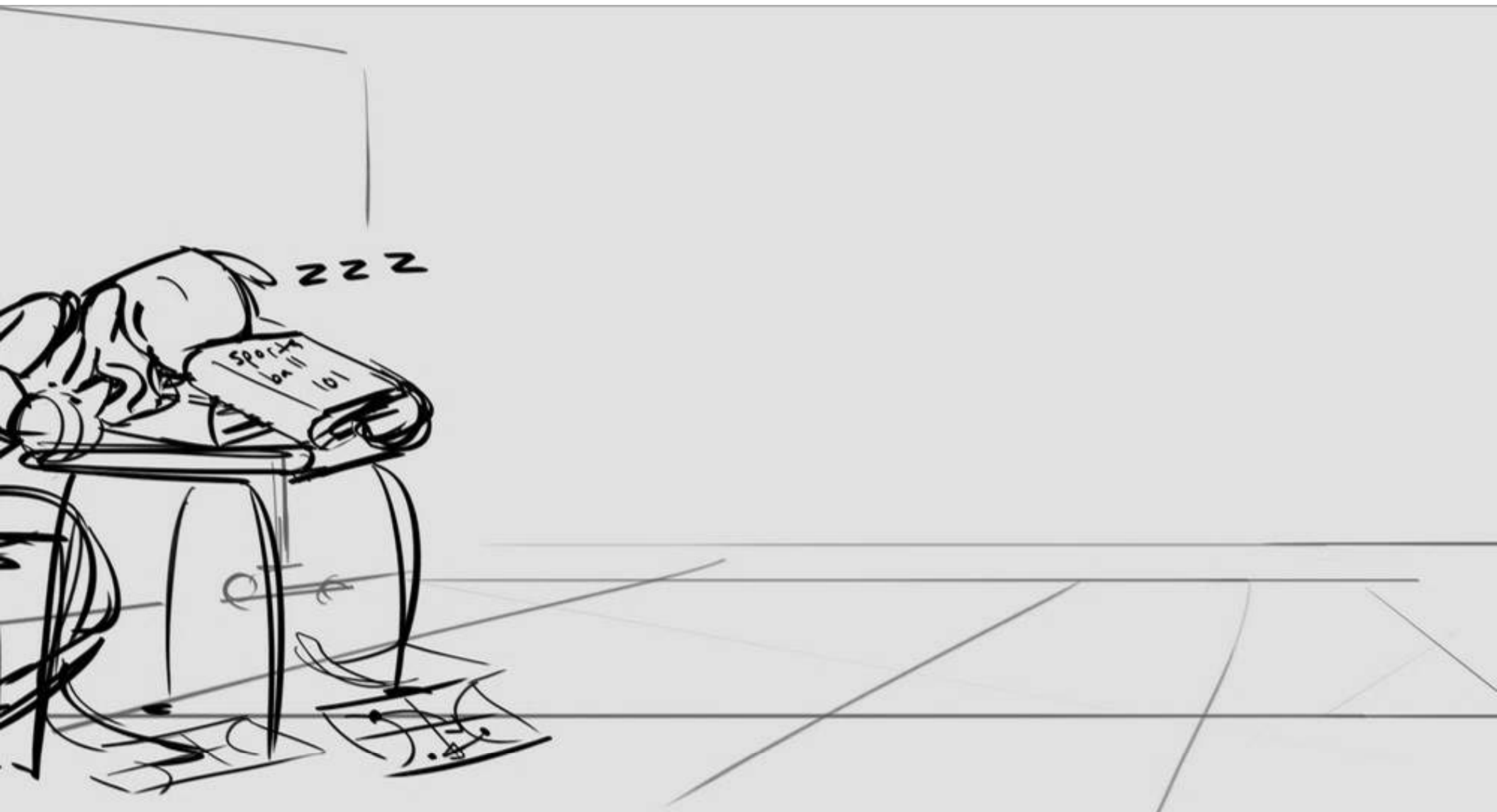

DAFFY: (snooooore)

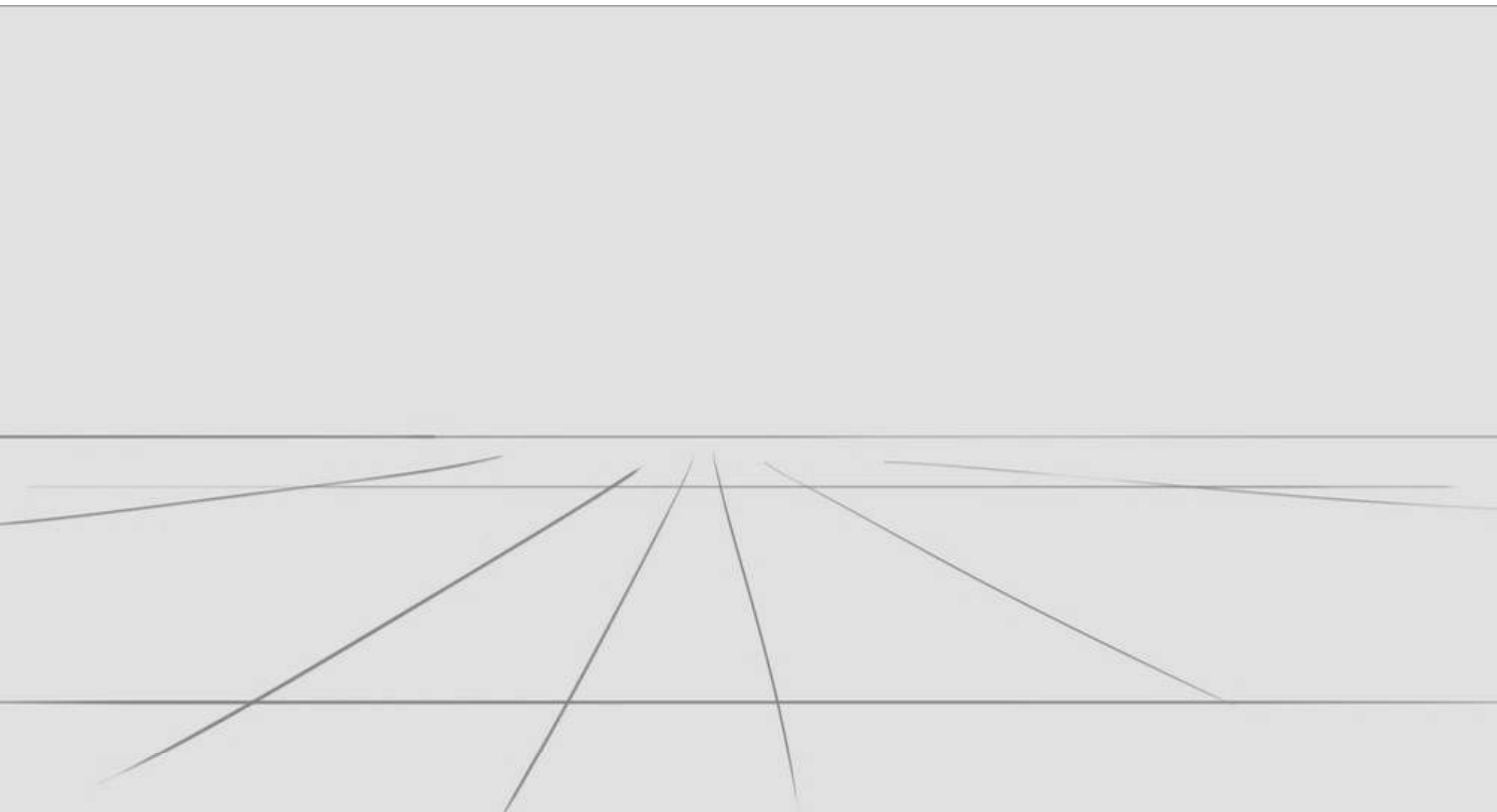

SFX: basketball bouncing

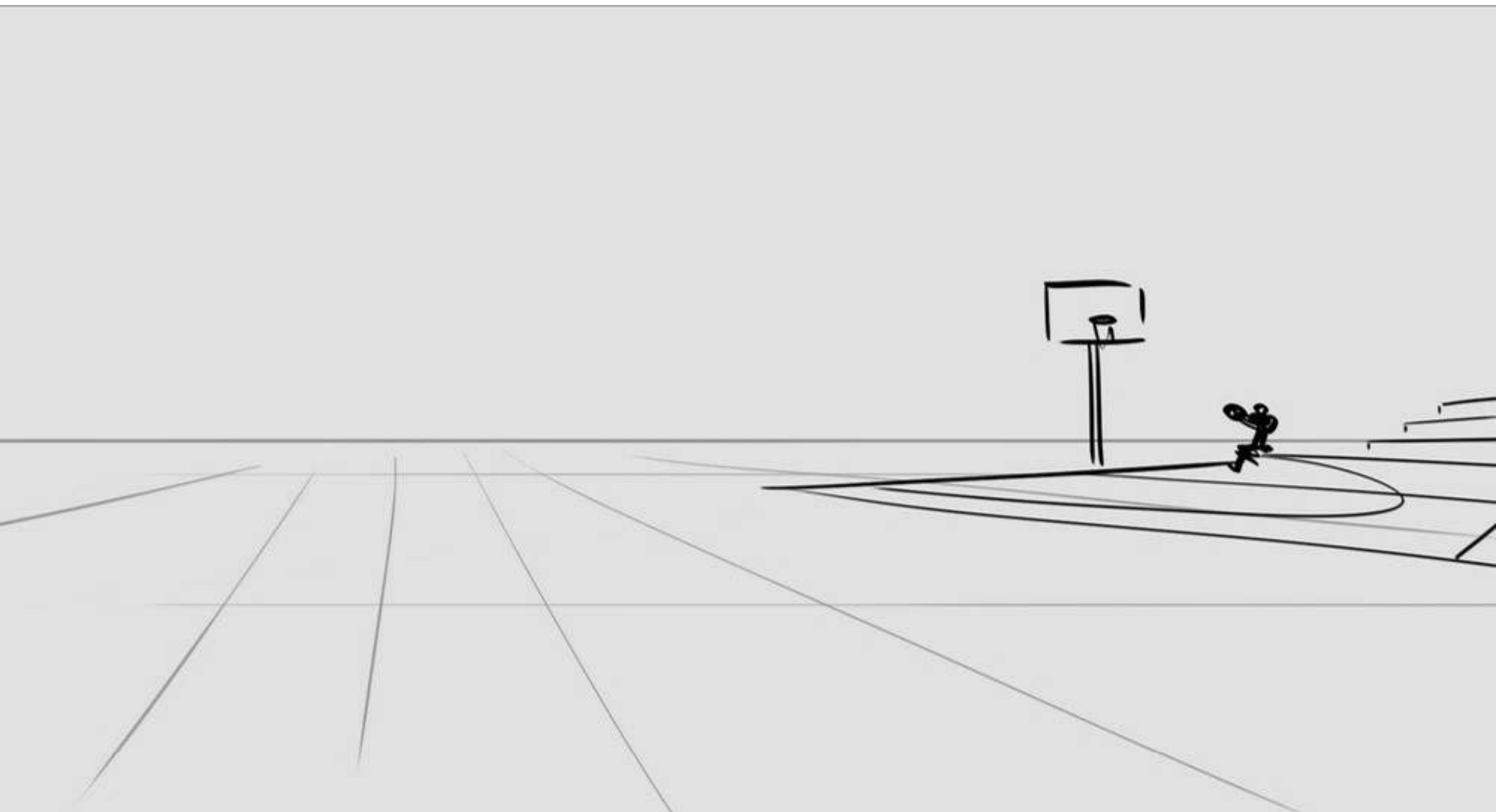

SFX: basketball bouncing

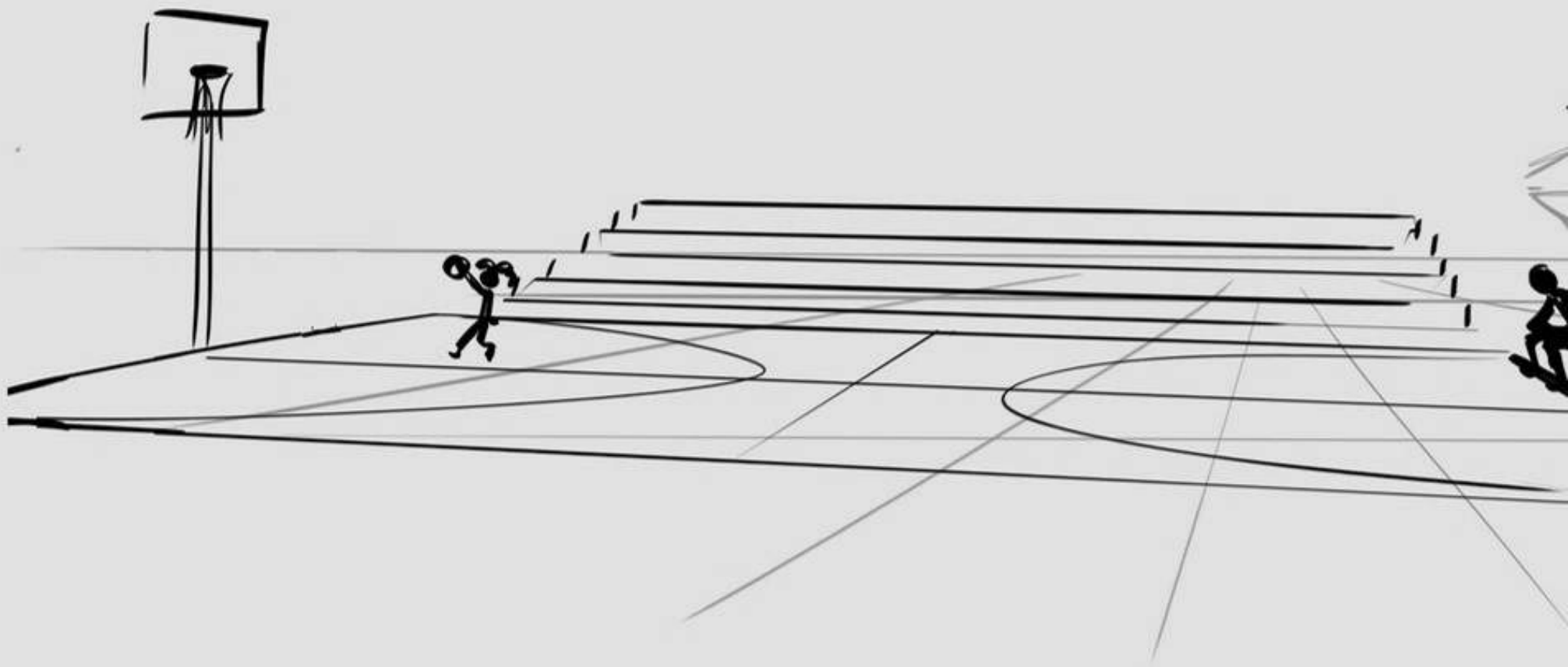

SFX: basketball bouncing

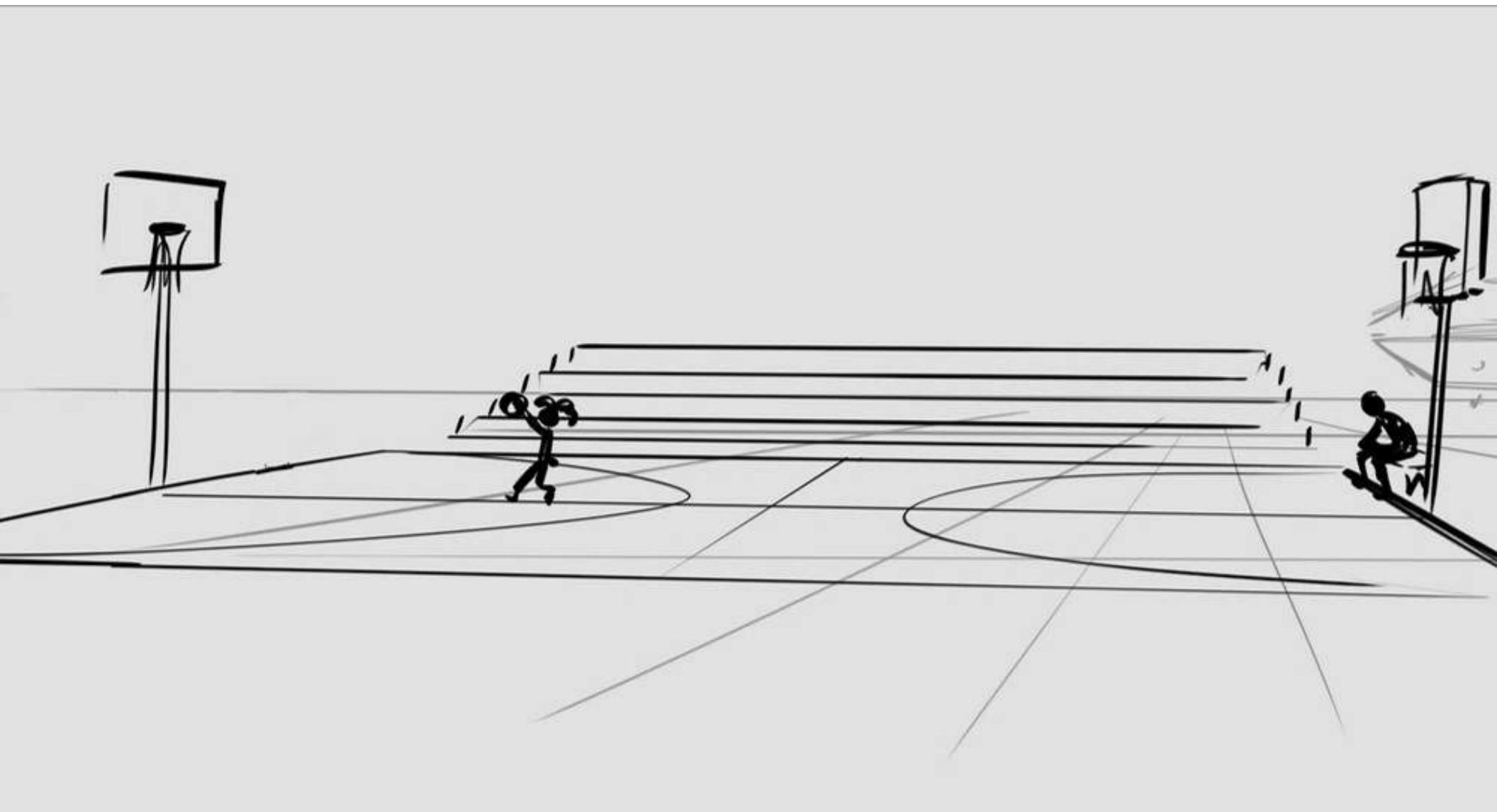

SFX: basketball bouncing

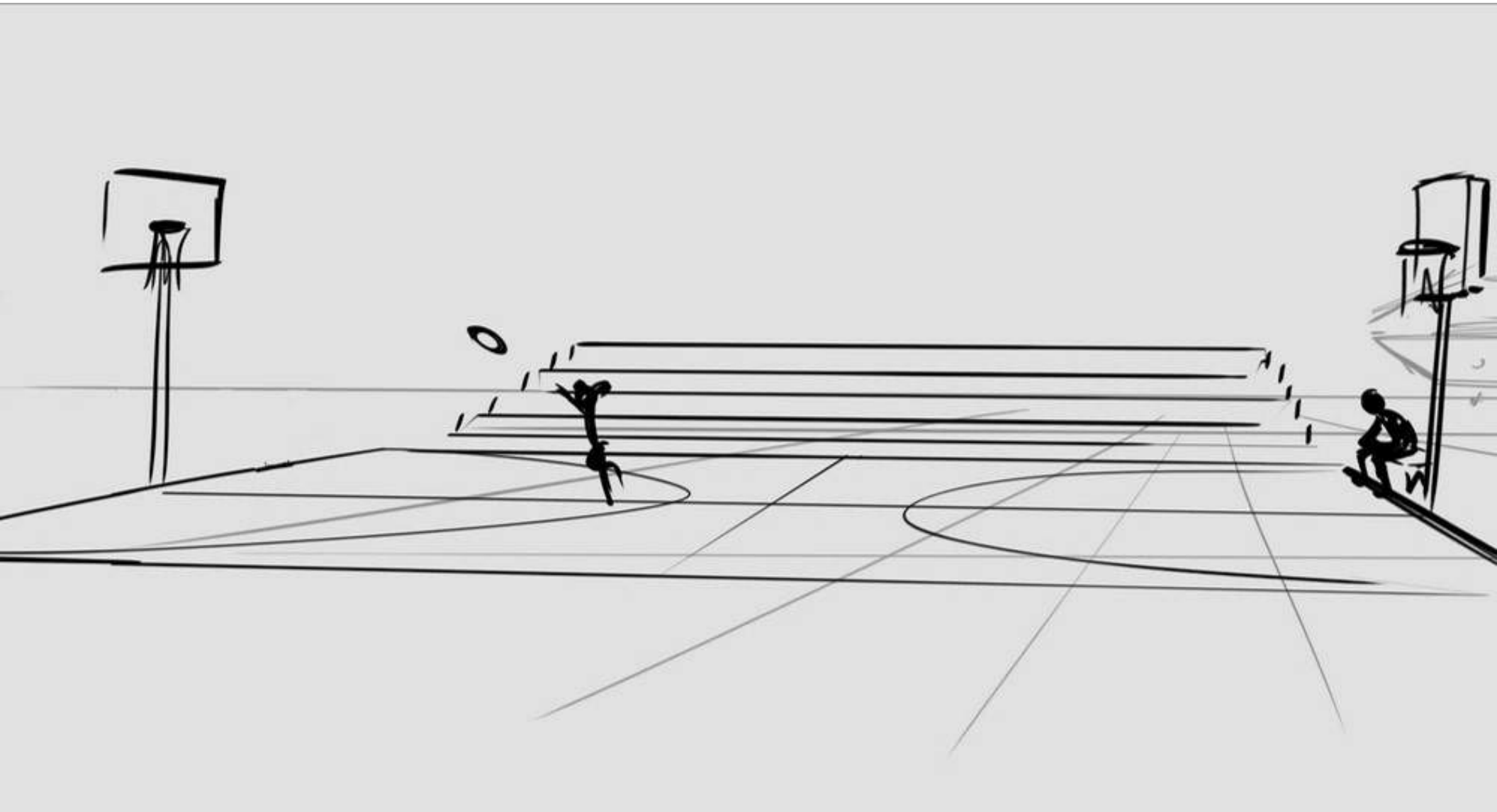

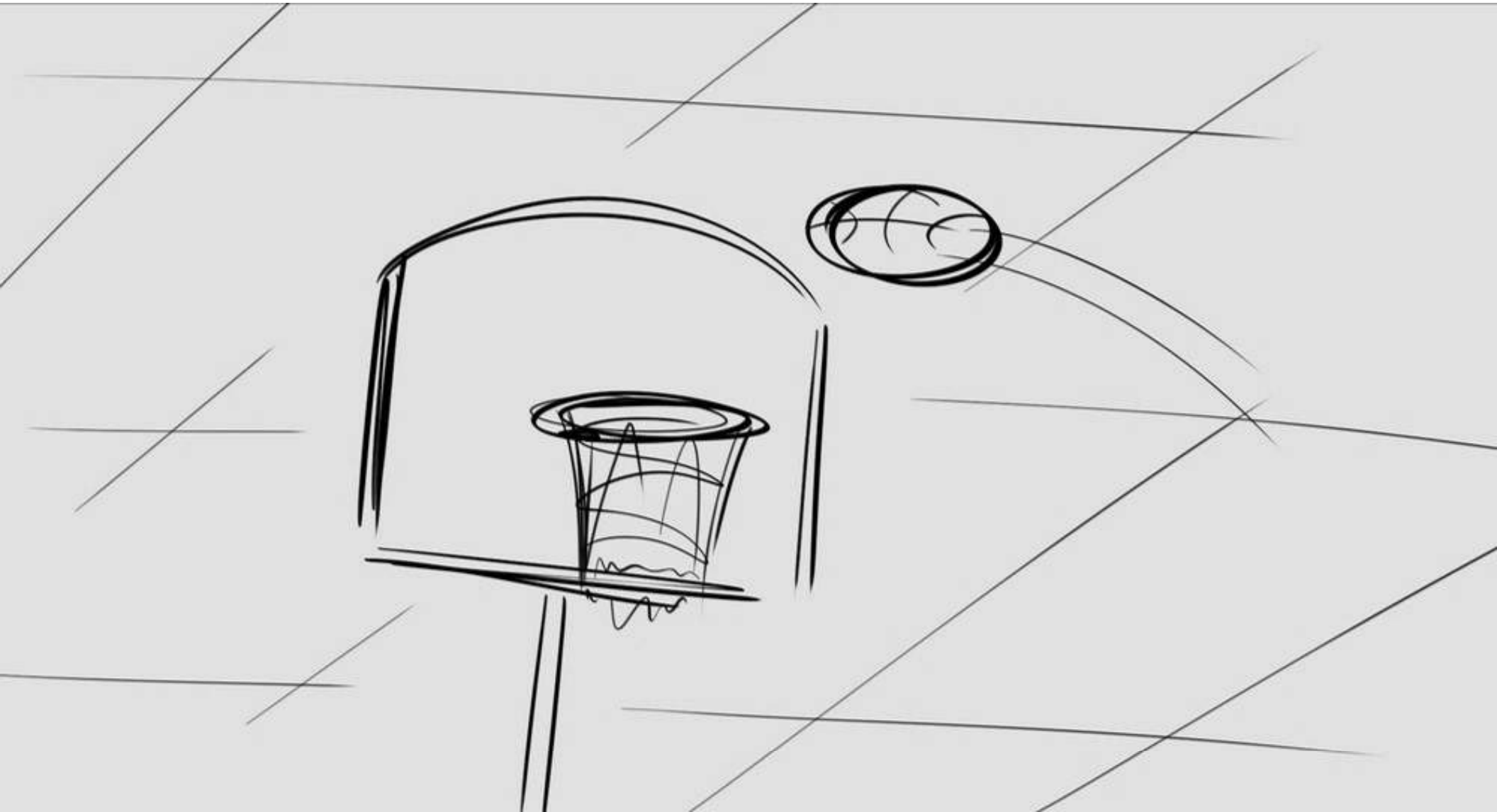

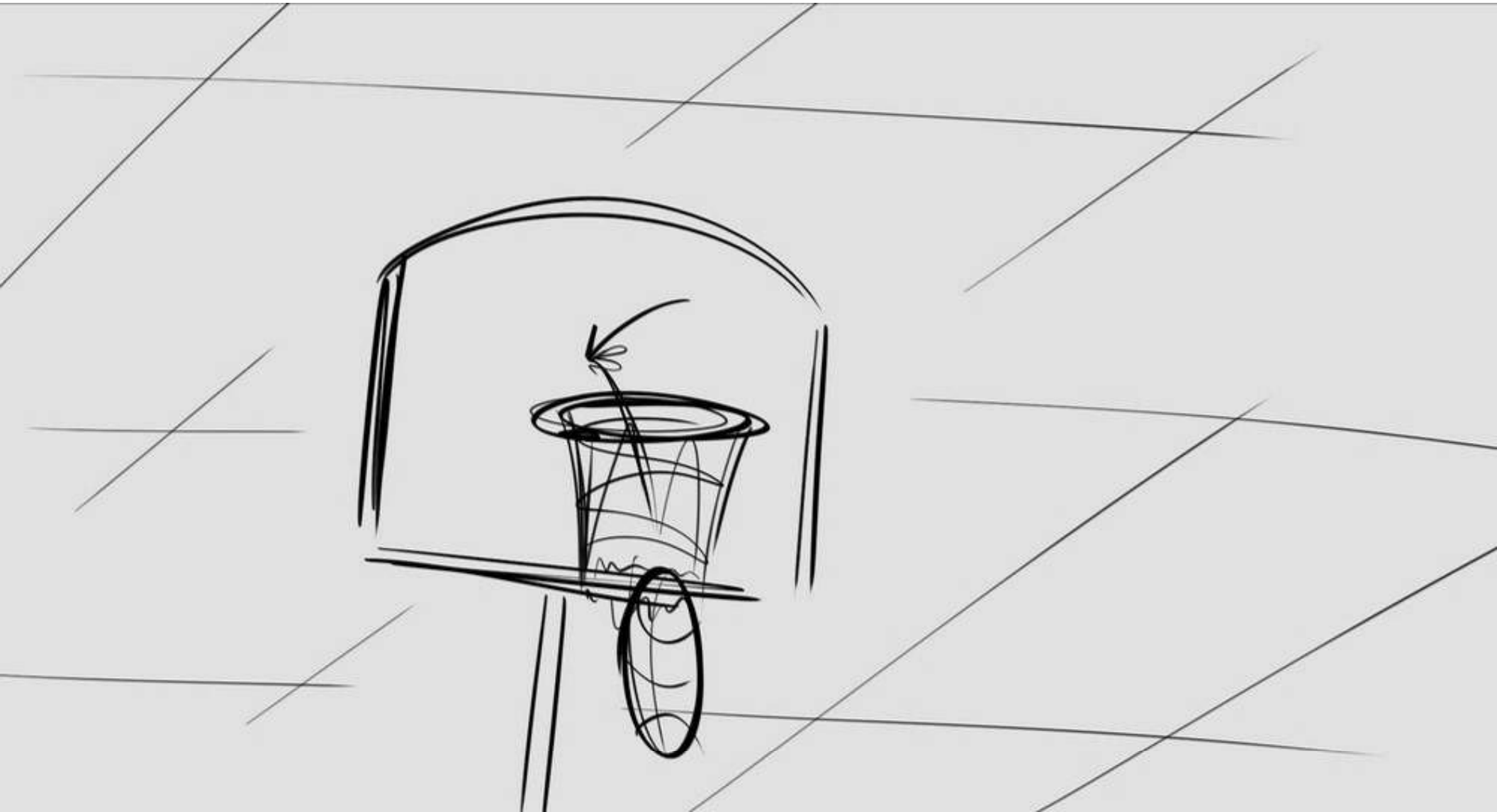



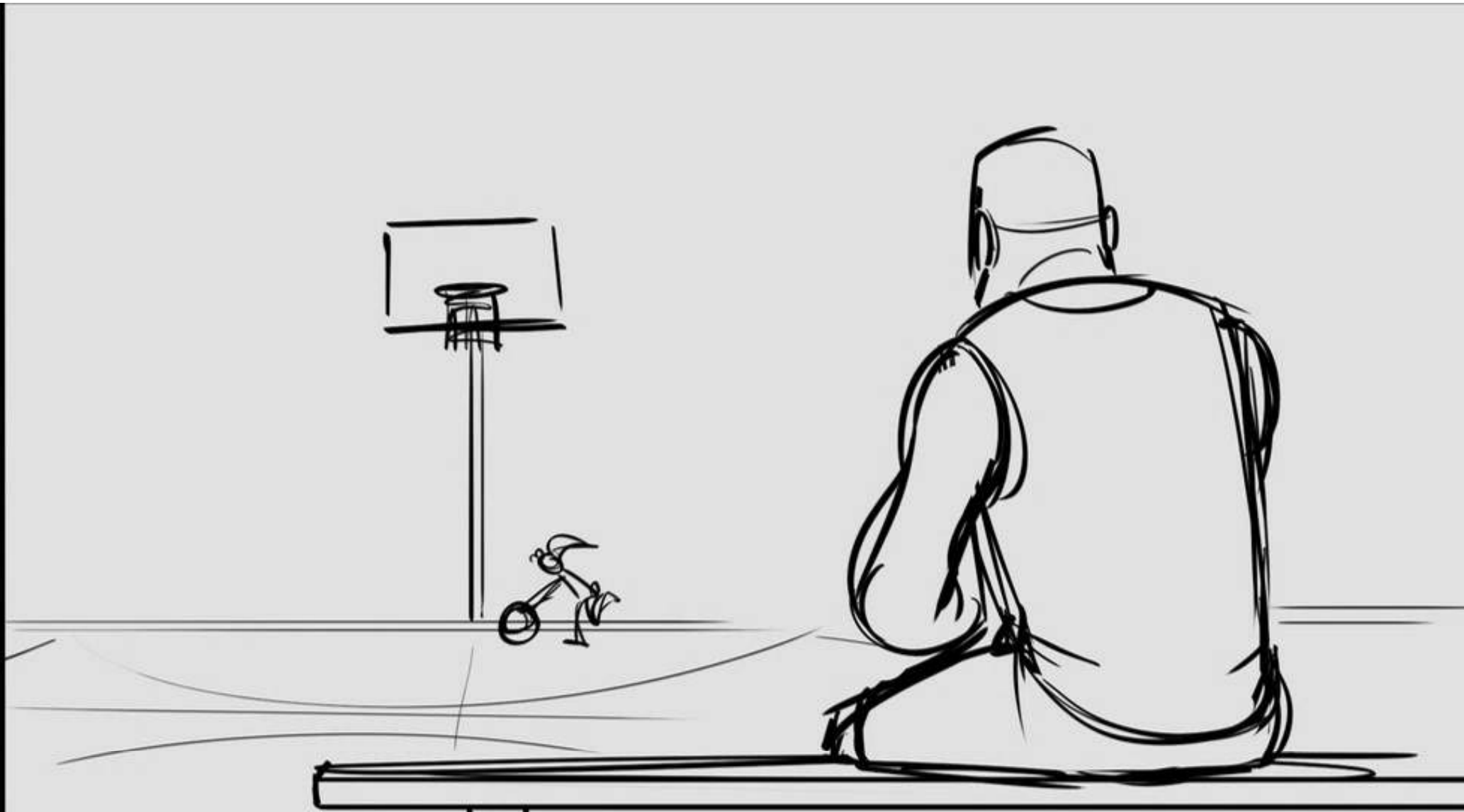







LOLA: Pre game ritual?



LOLA: Pre game ritual?



LEBRON: I like to remind myself who I'm playing for.



LEBRON: I like to remind myself who I'm playing for.



LEBRON: My family.



LEBRON: And right now it's all about my son.



LEBRON: Dom.













LEBRON: Who do you play for?









LOLA: I'm not....sure anymore.



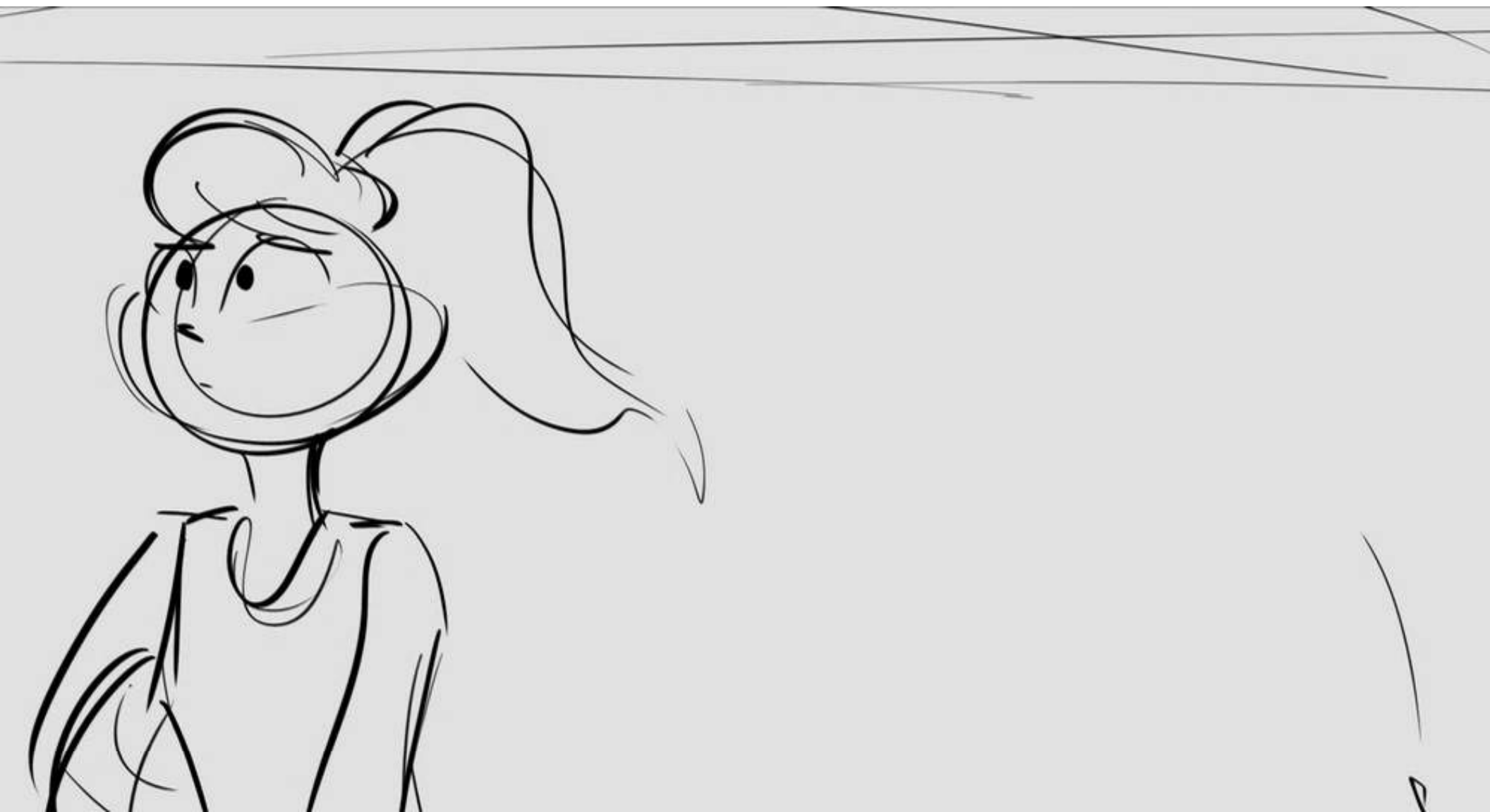

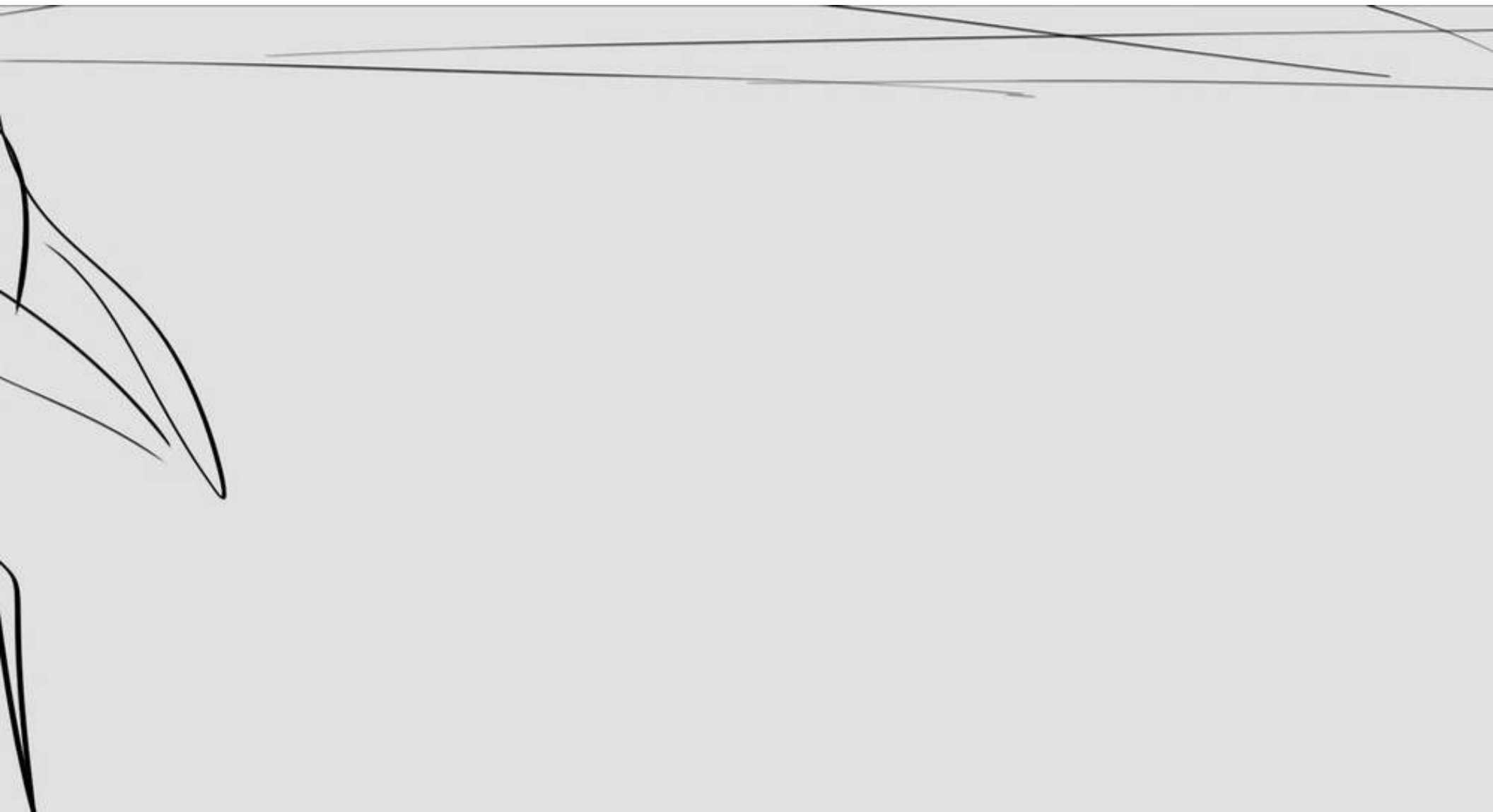







LOLA: I mean, I'm playing for my old friends.



LOLA: I mean, I'm playing for my old friends.



LOLA: I mean, I'm playing for my old friends.



LOLA: I want them to get their home back!

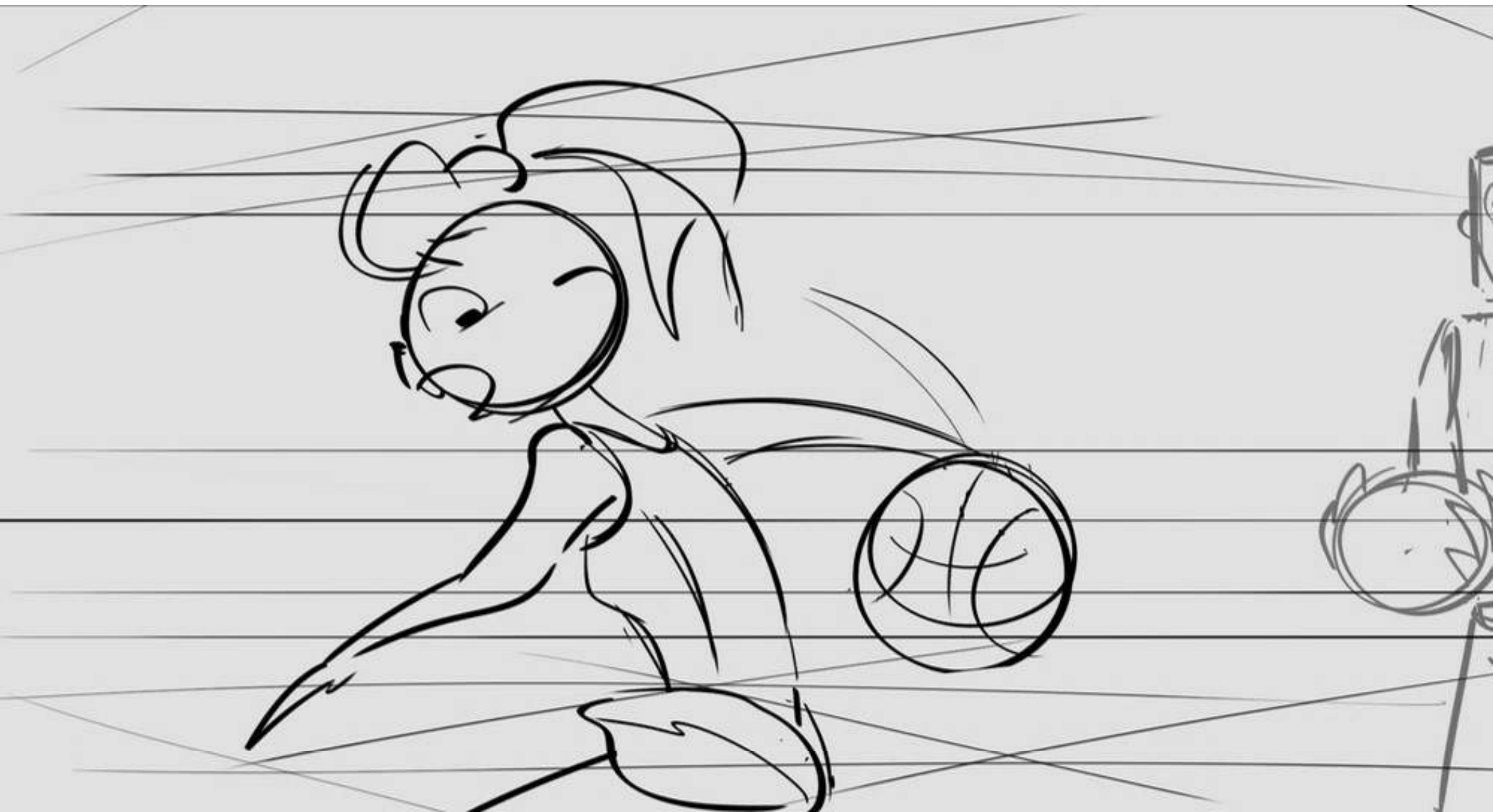

LOLA: I want them to get their home back!



LOLA: I want them to get their home back!

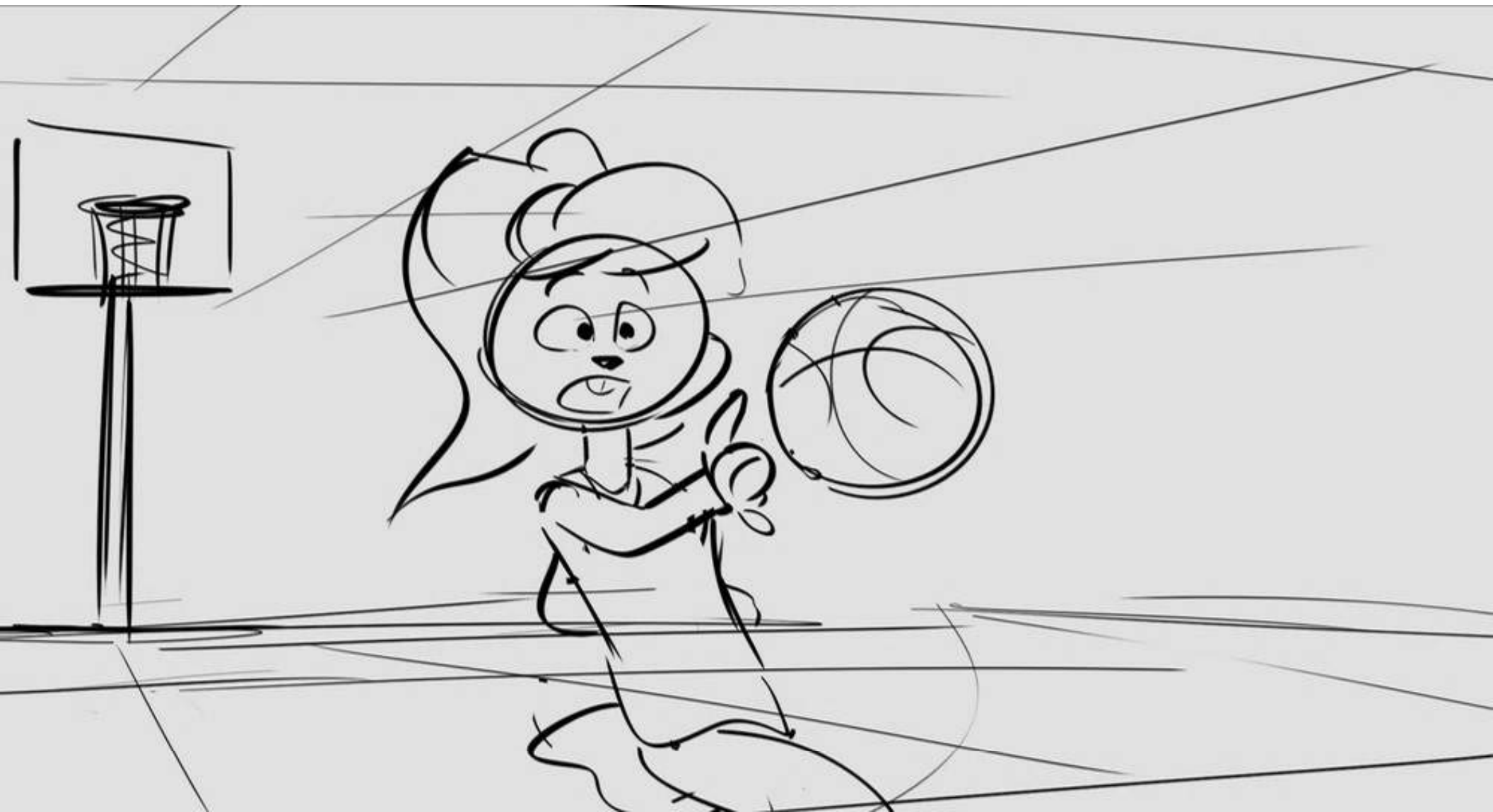

LOLA: To be Looney!

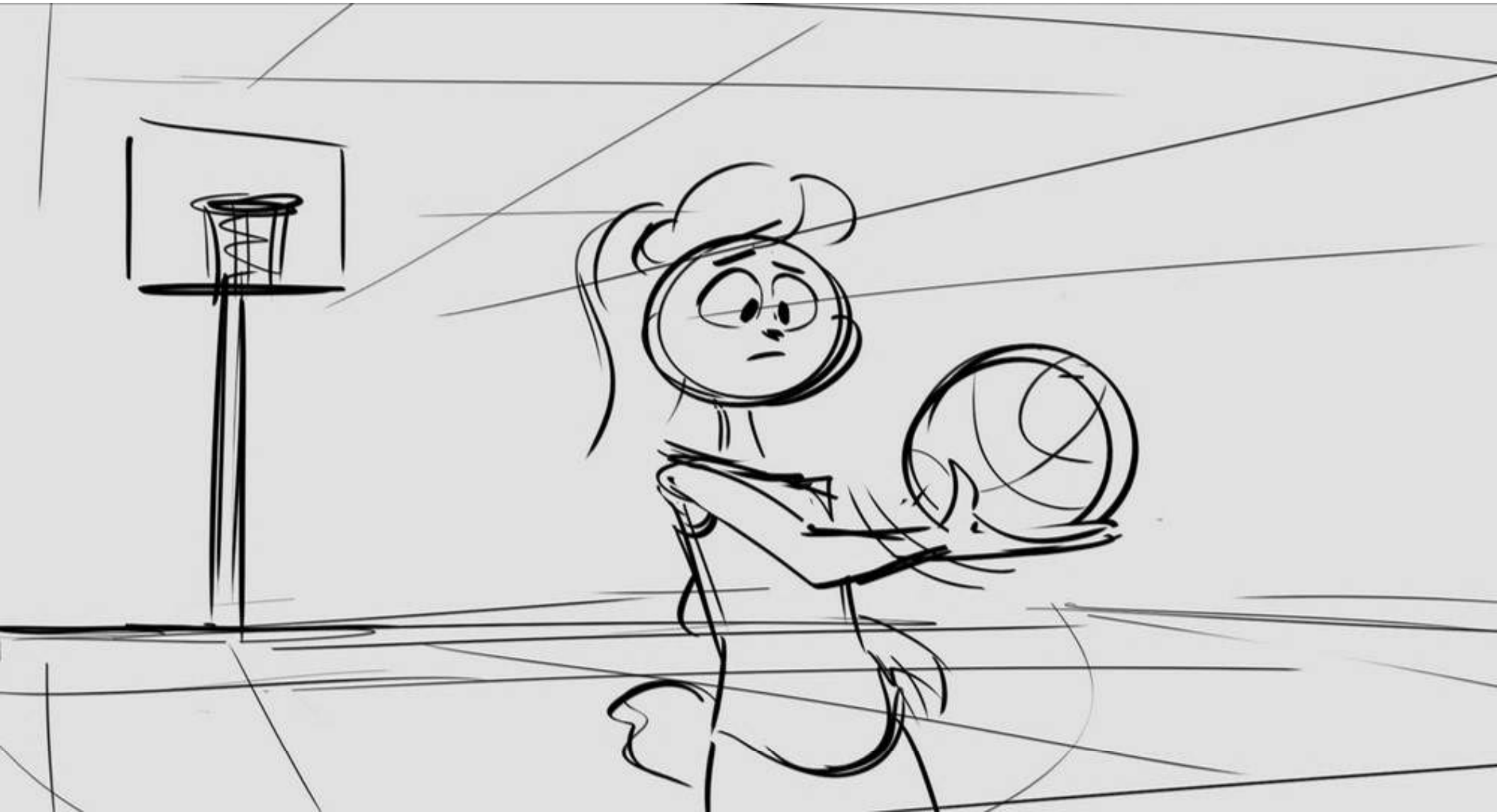



LOLA: Especially Bugs.

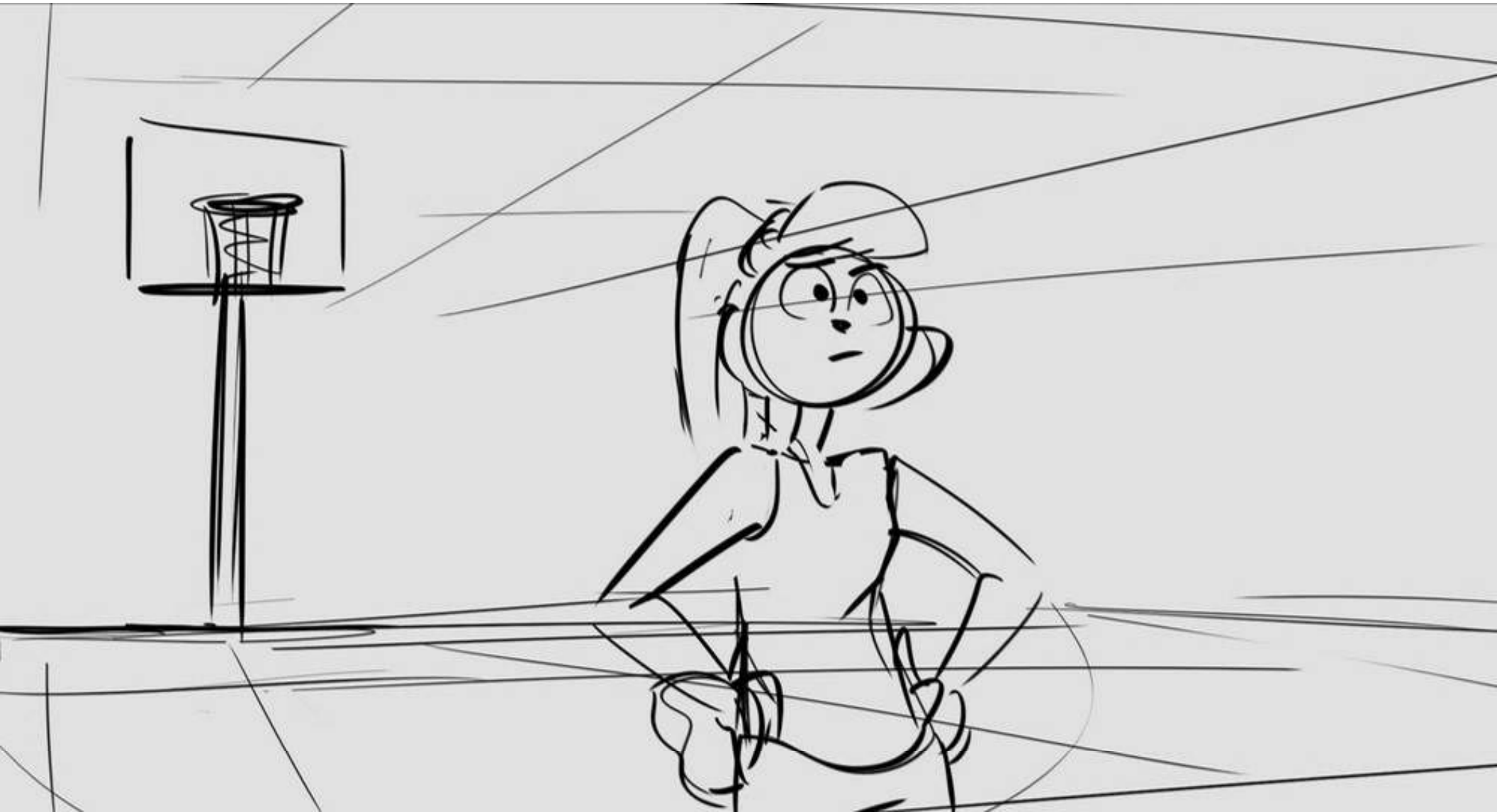



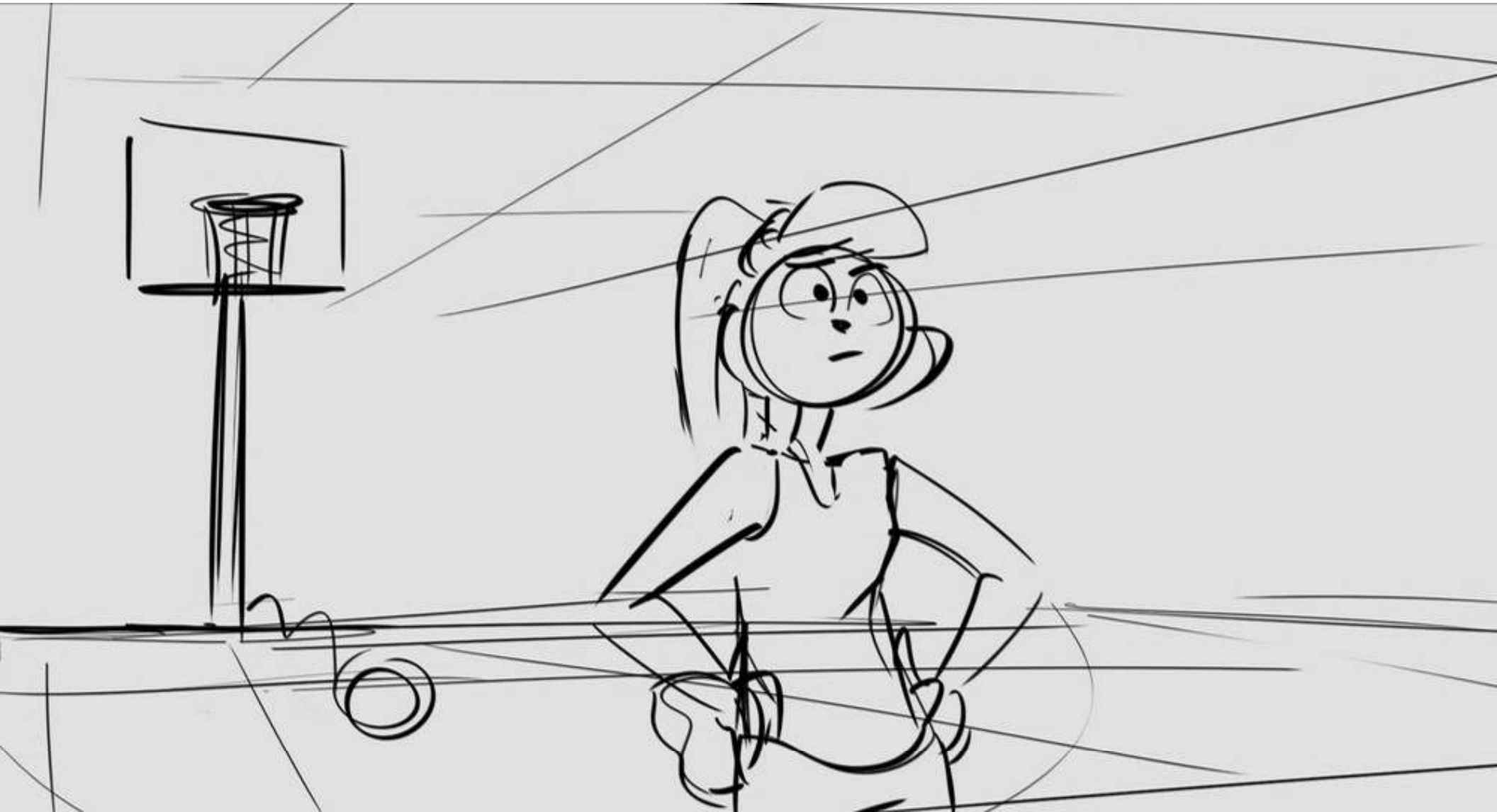



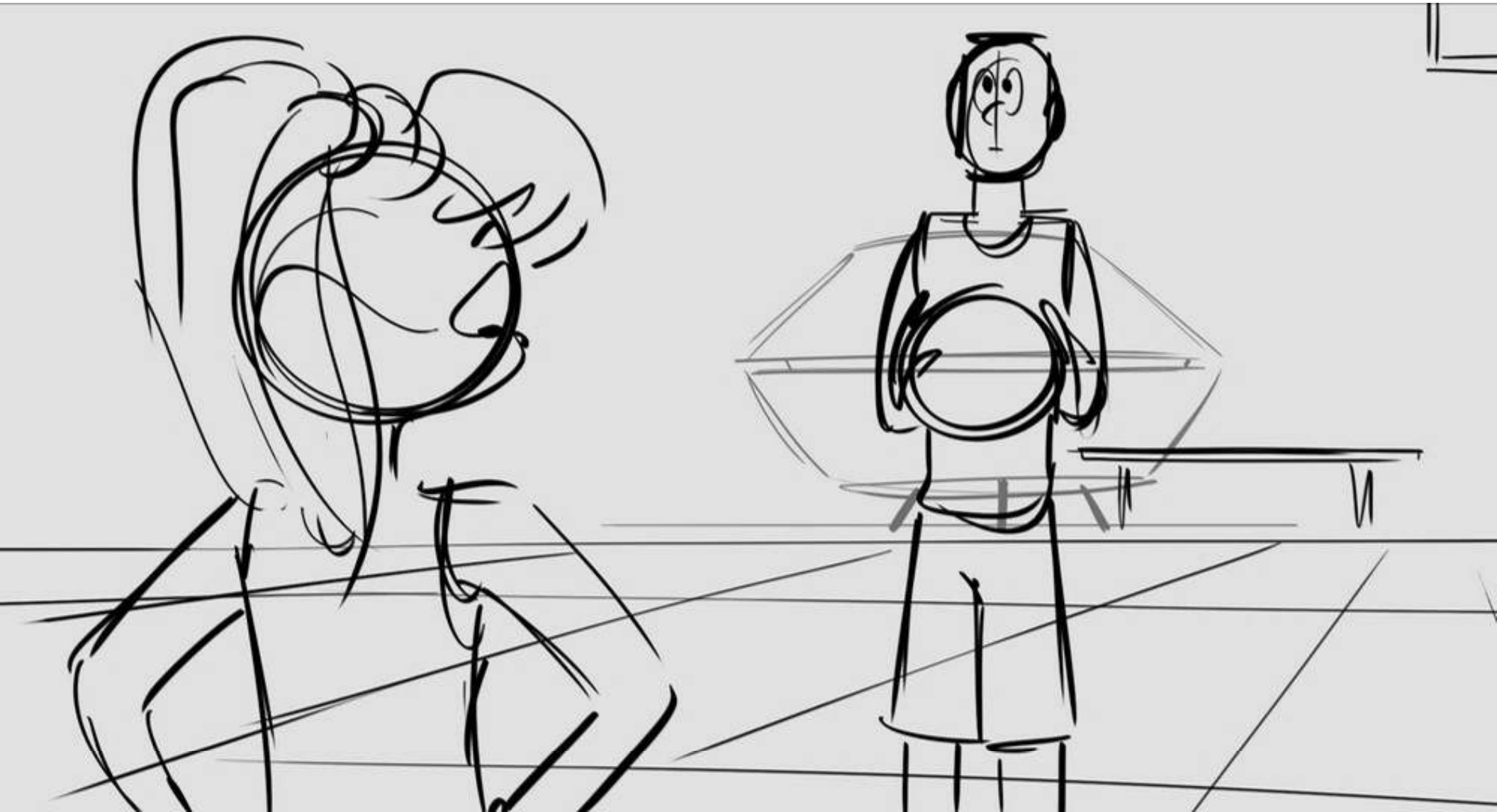







LEBRON: Yeah, let me tell you

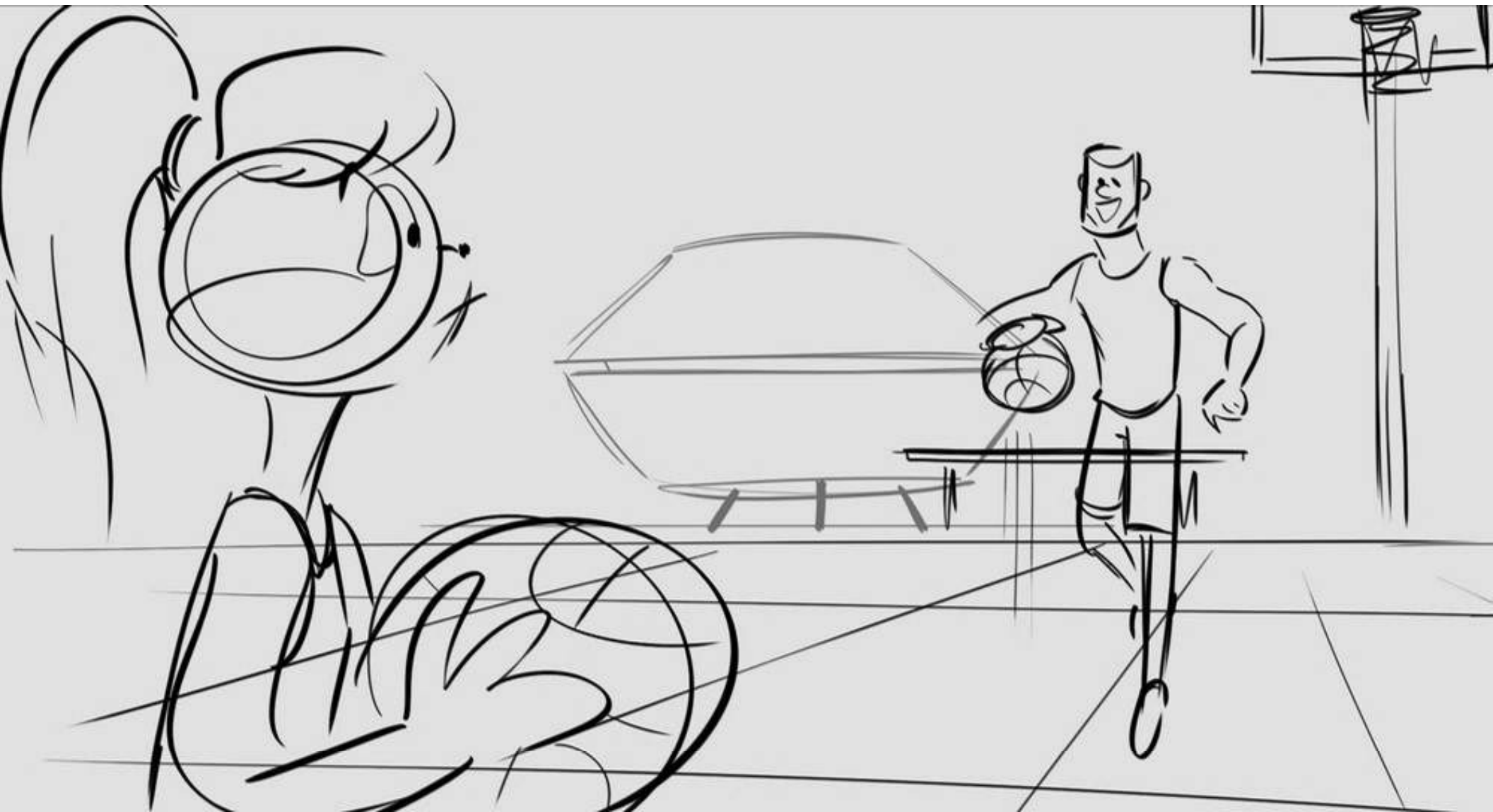

LEBRON: he really missed you guys.

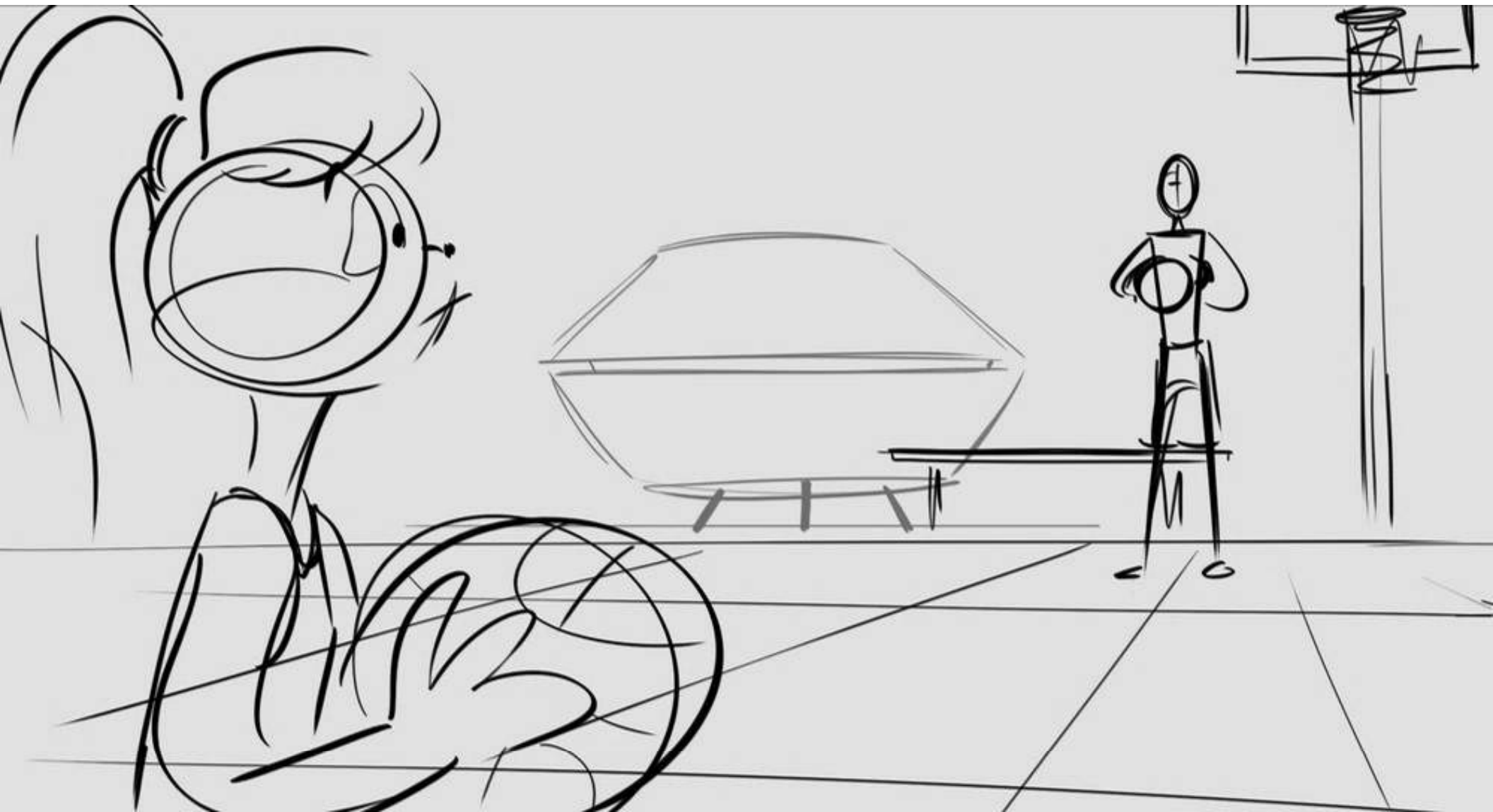

LEBRON: Bugs was not thriving on his own.

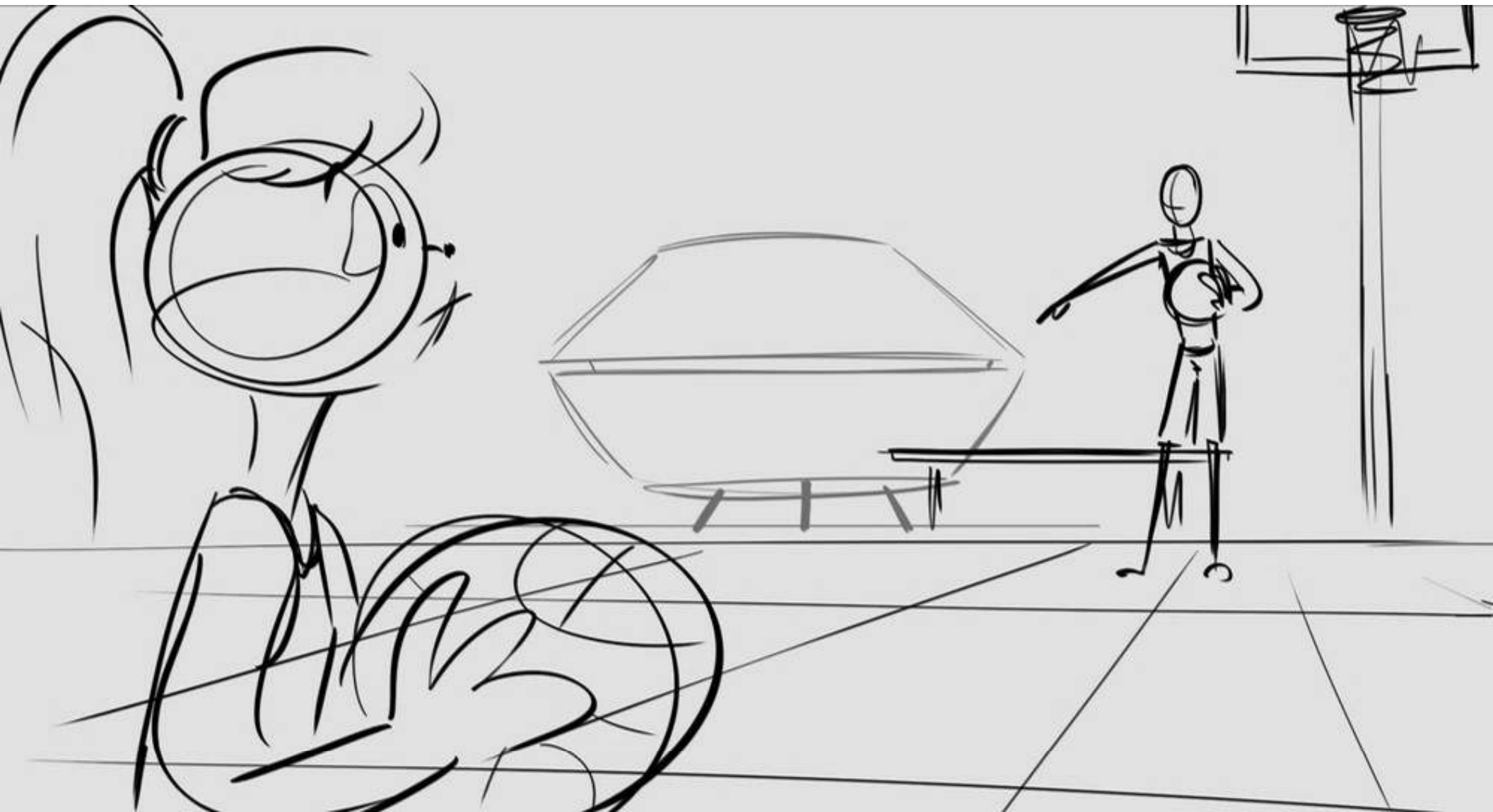

LEBRON: Off the floor,

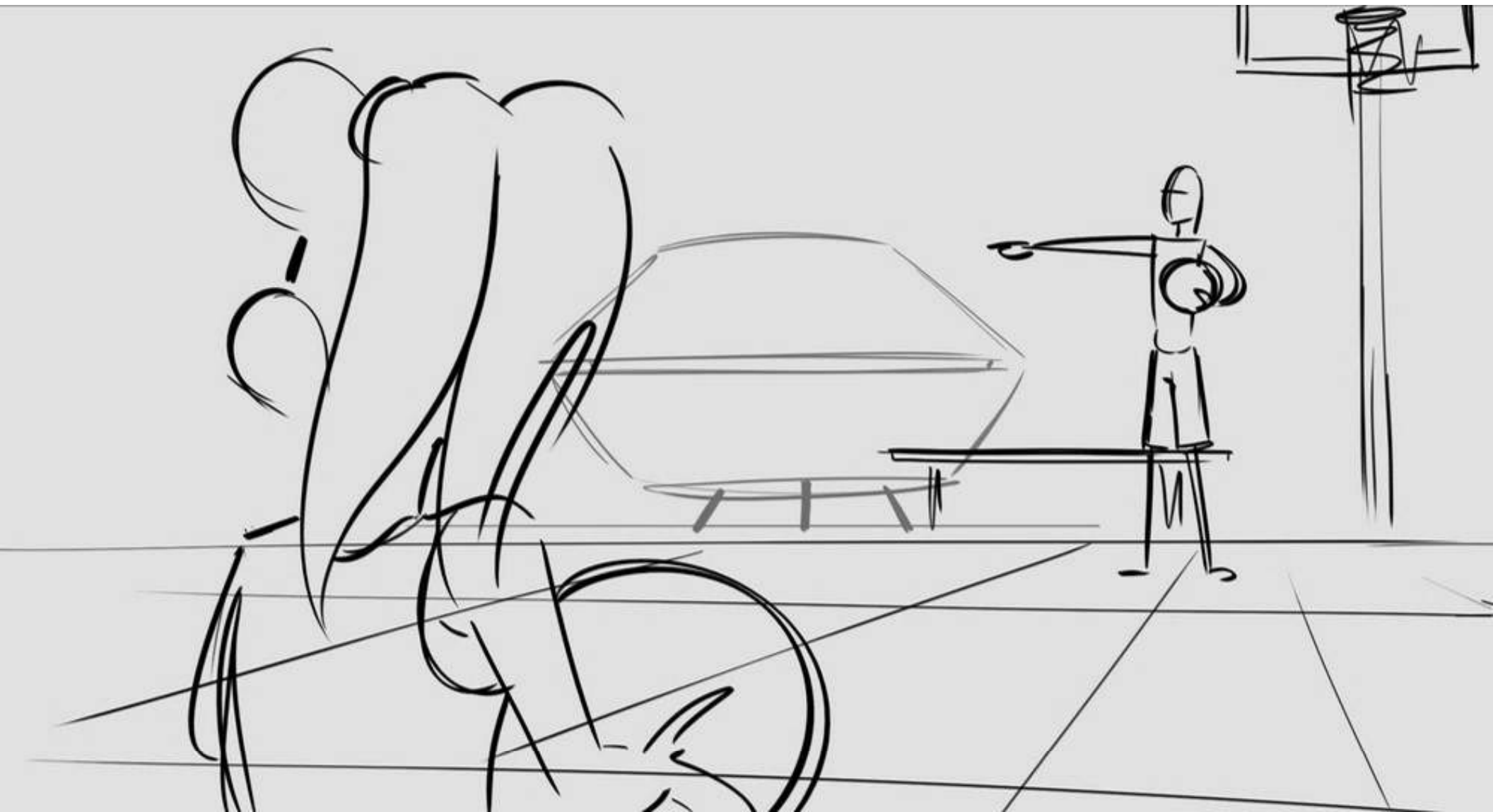

LEBRON: through the bleachers.

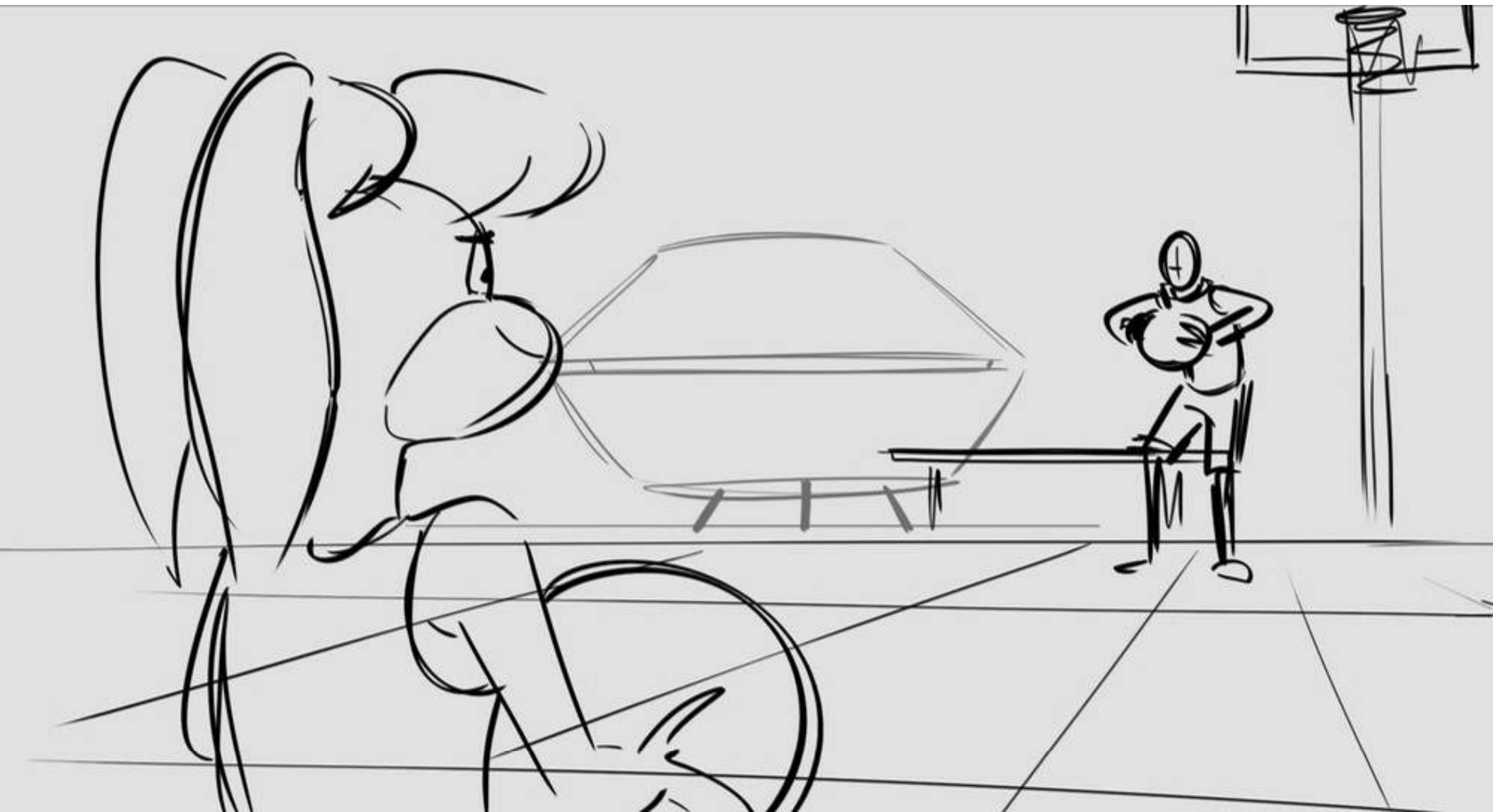

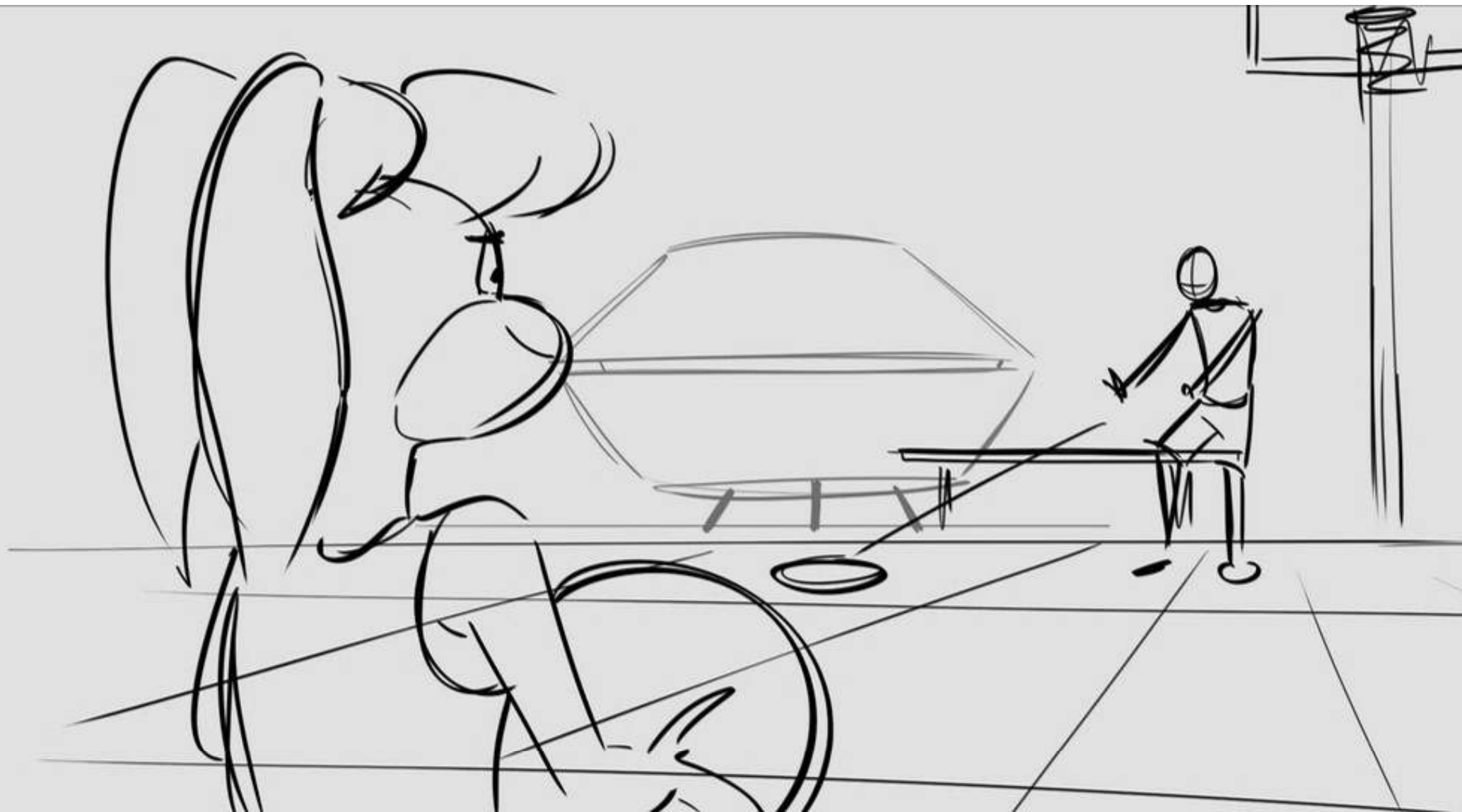



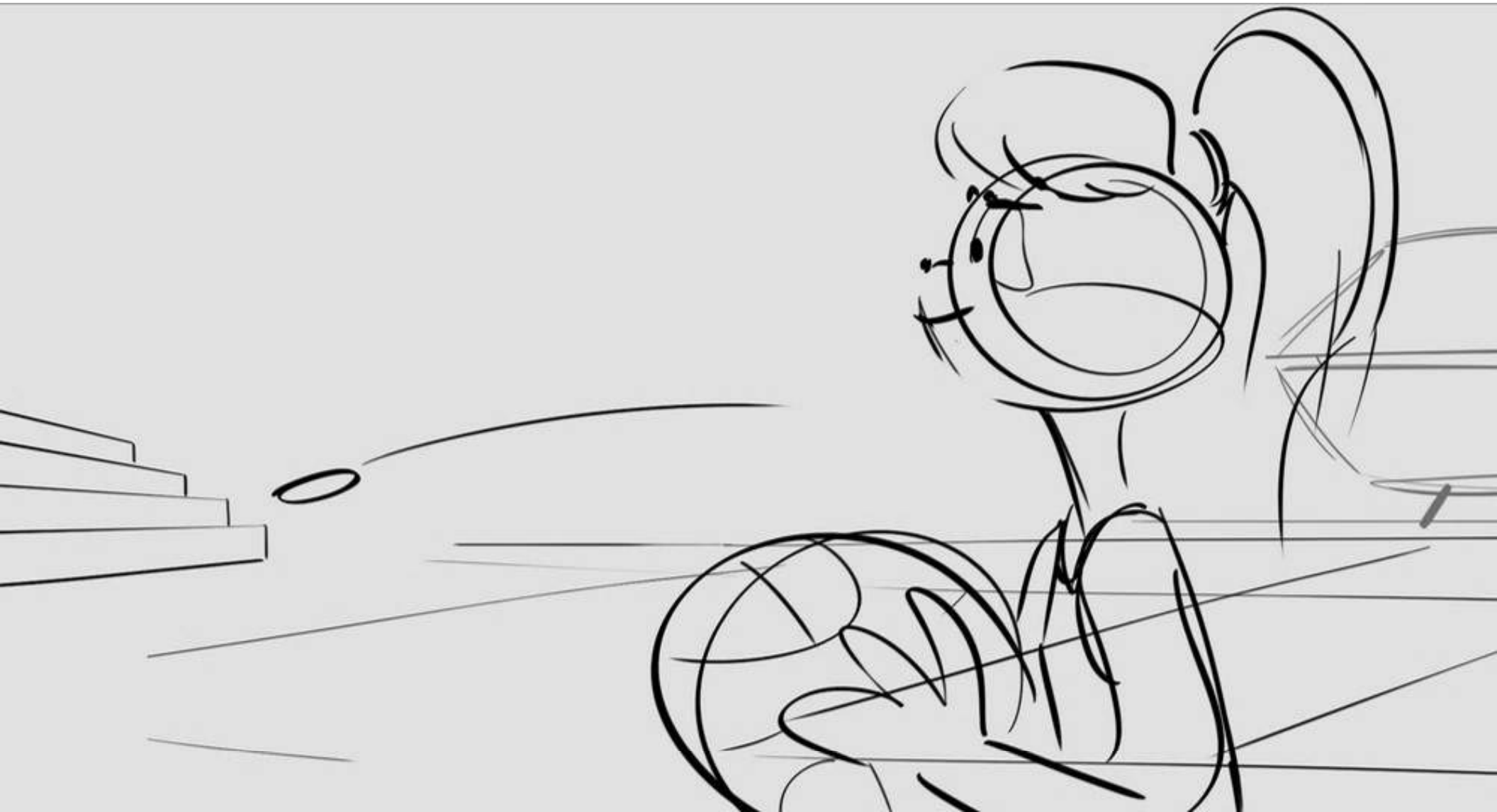



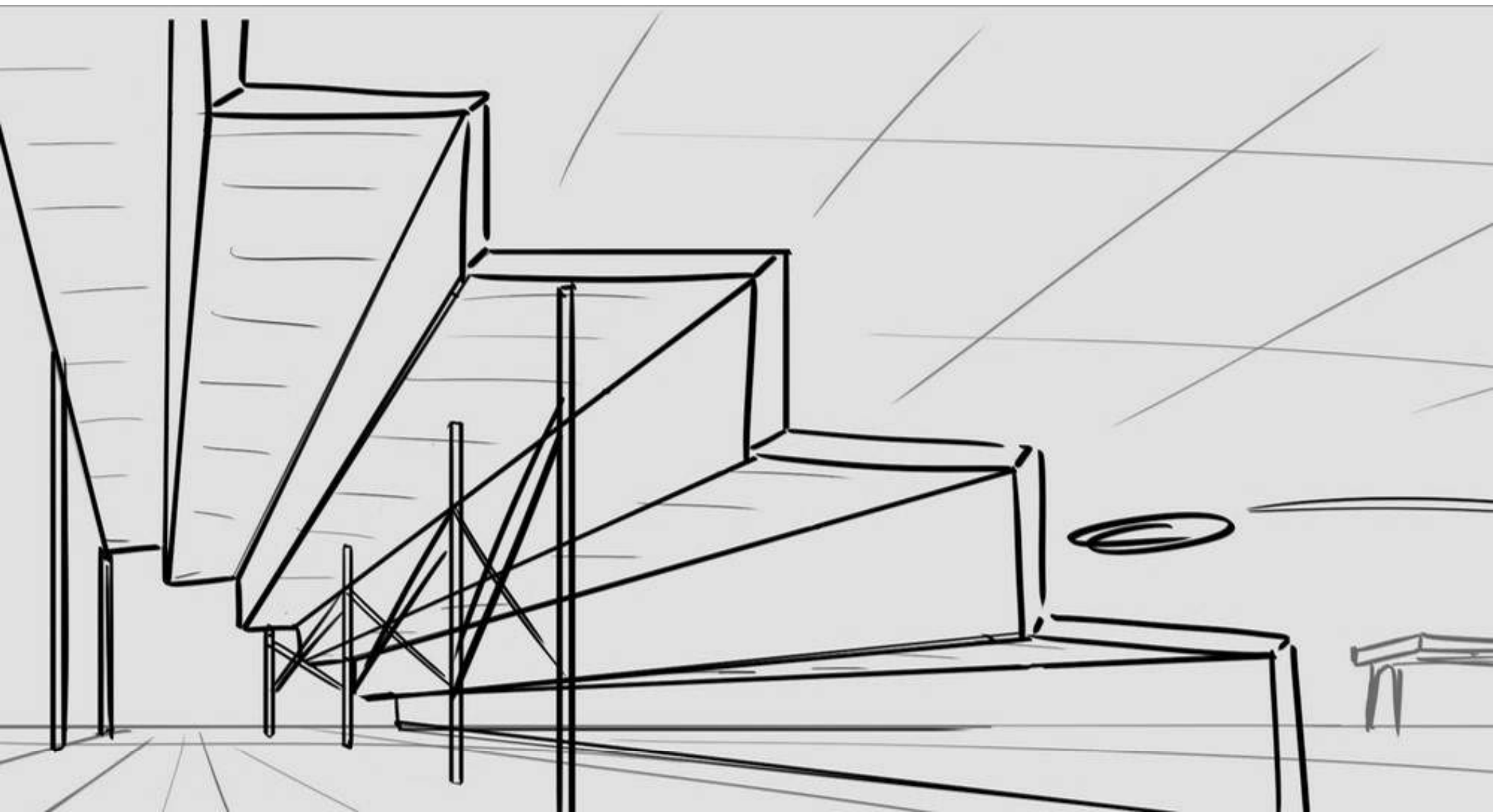

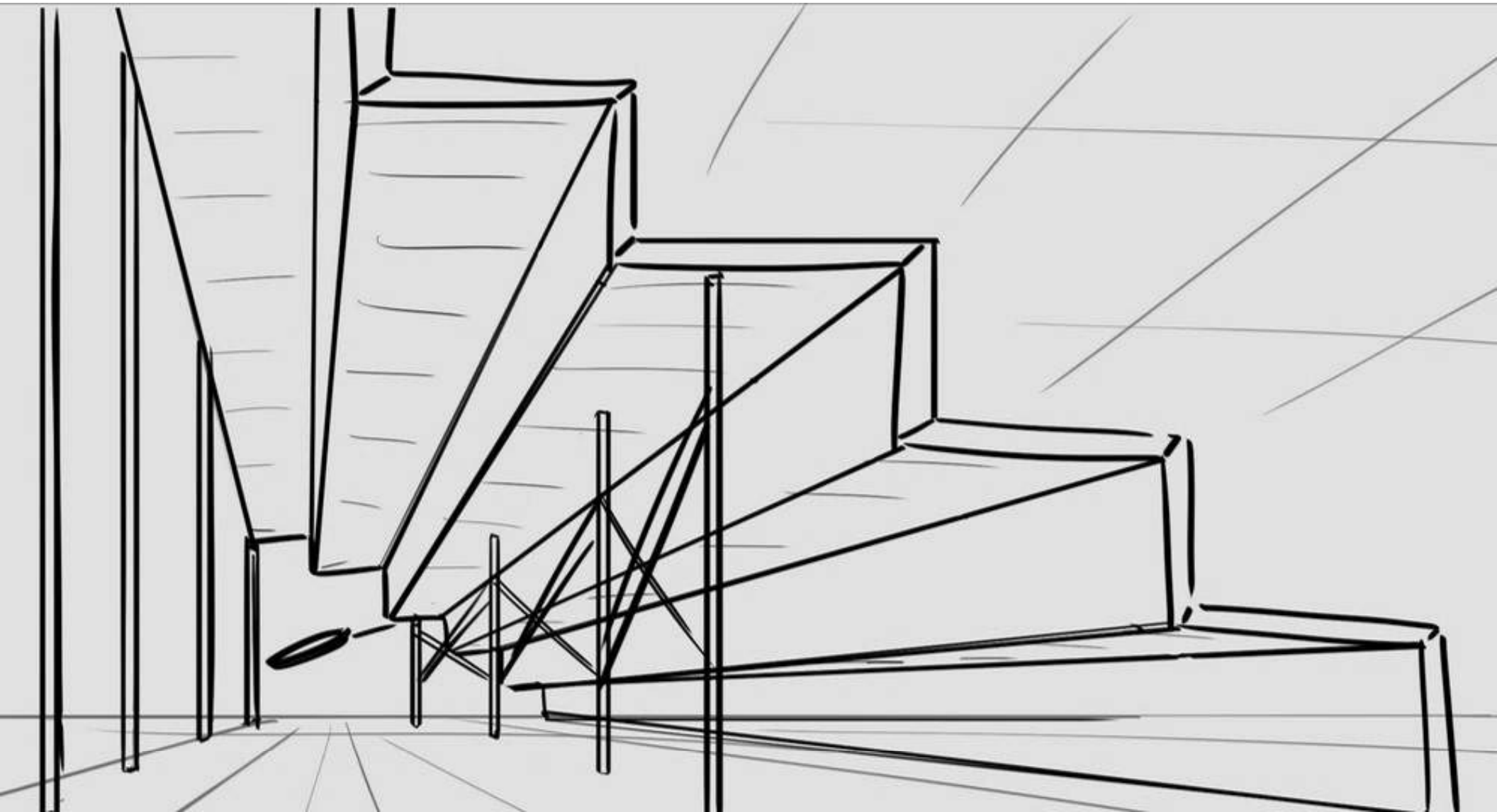

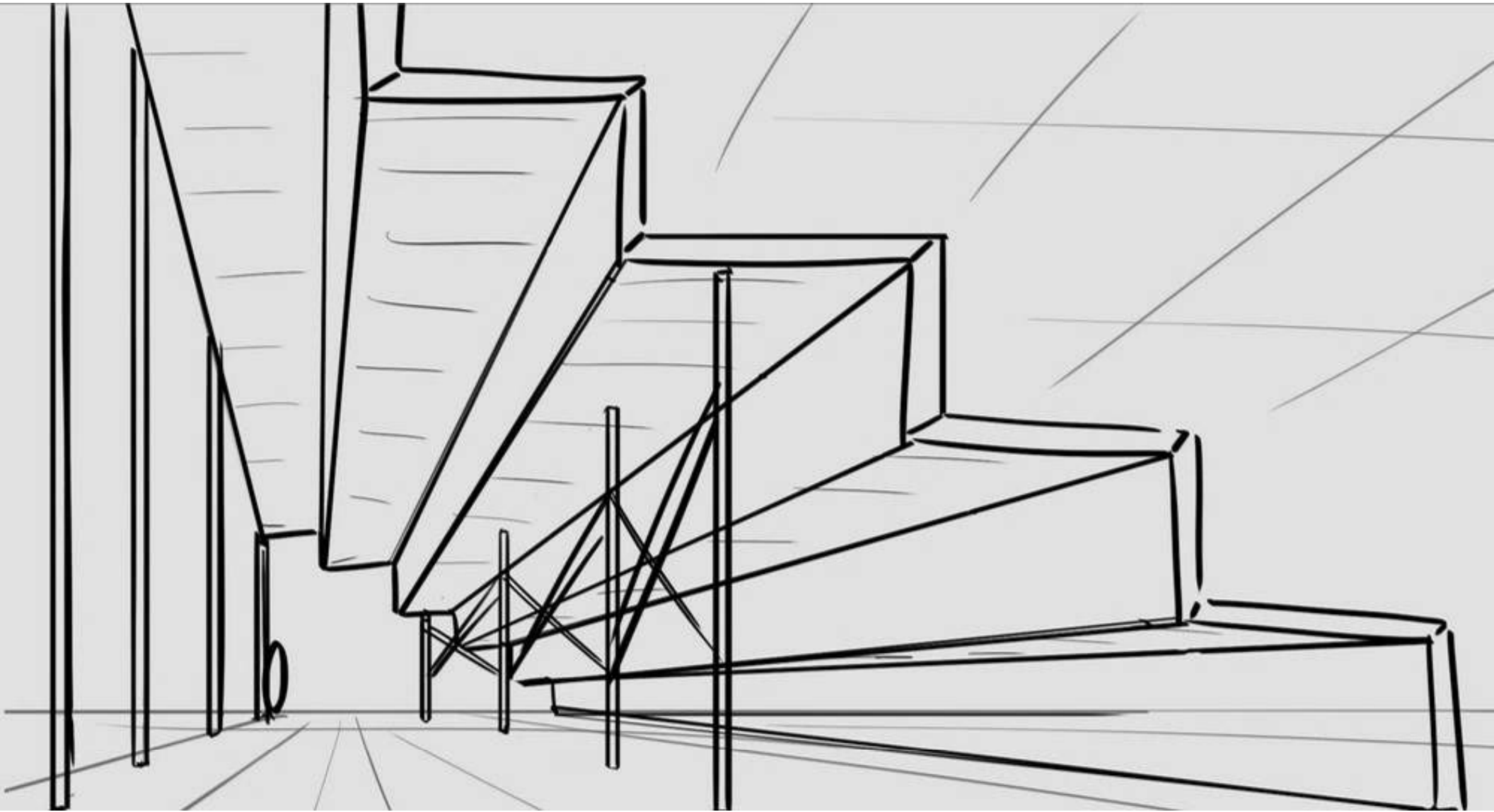

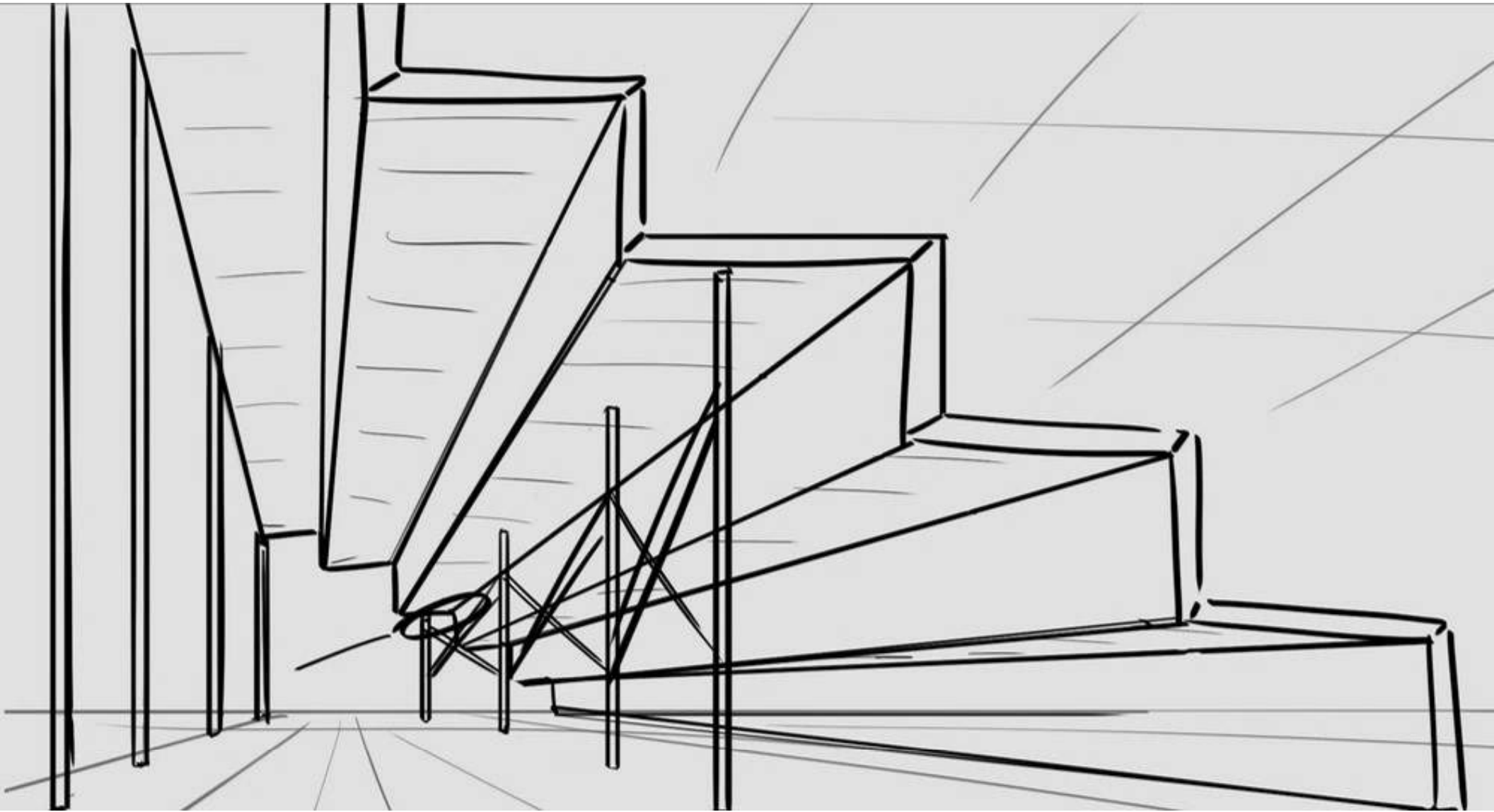

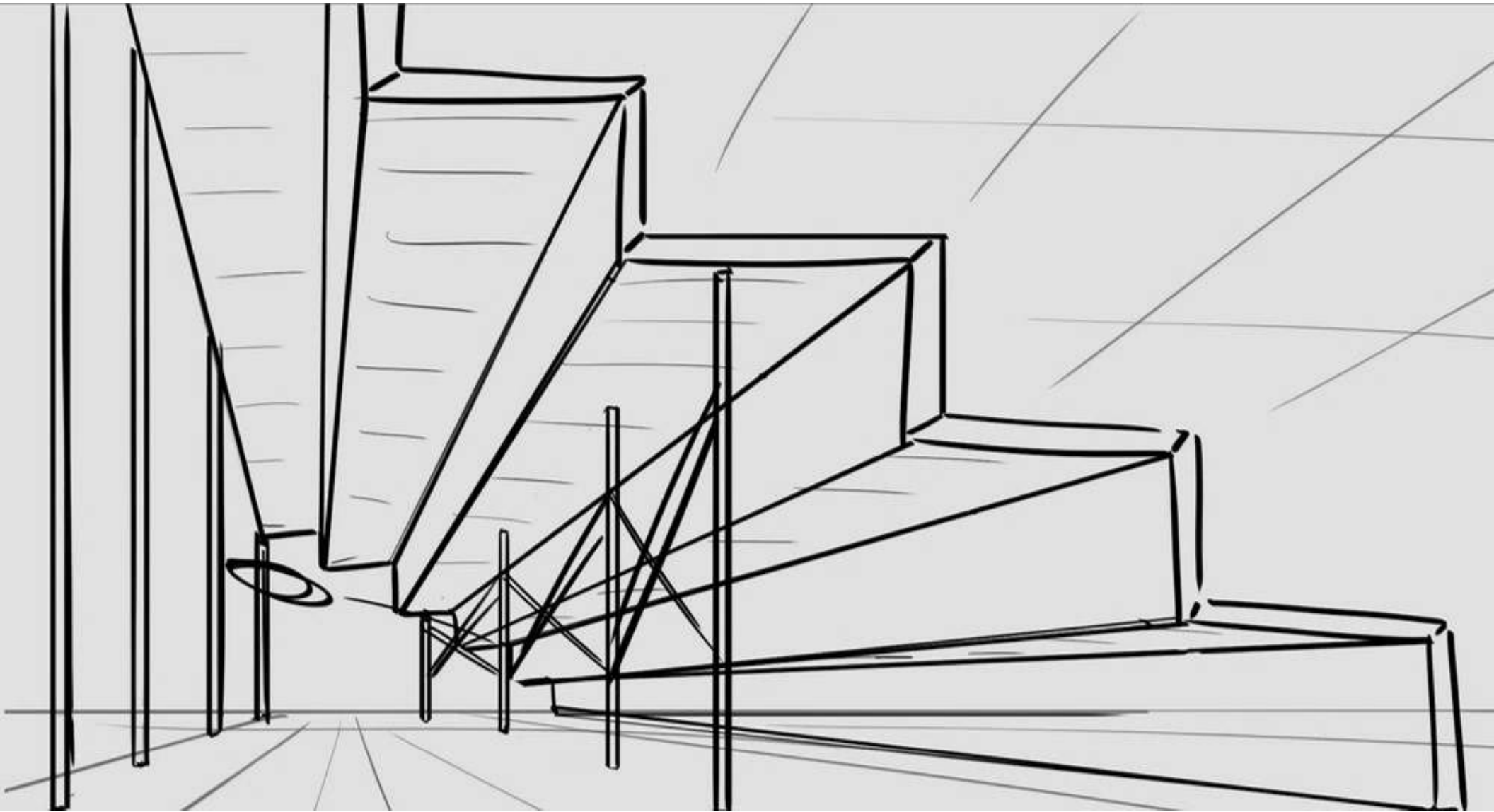

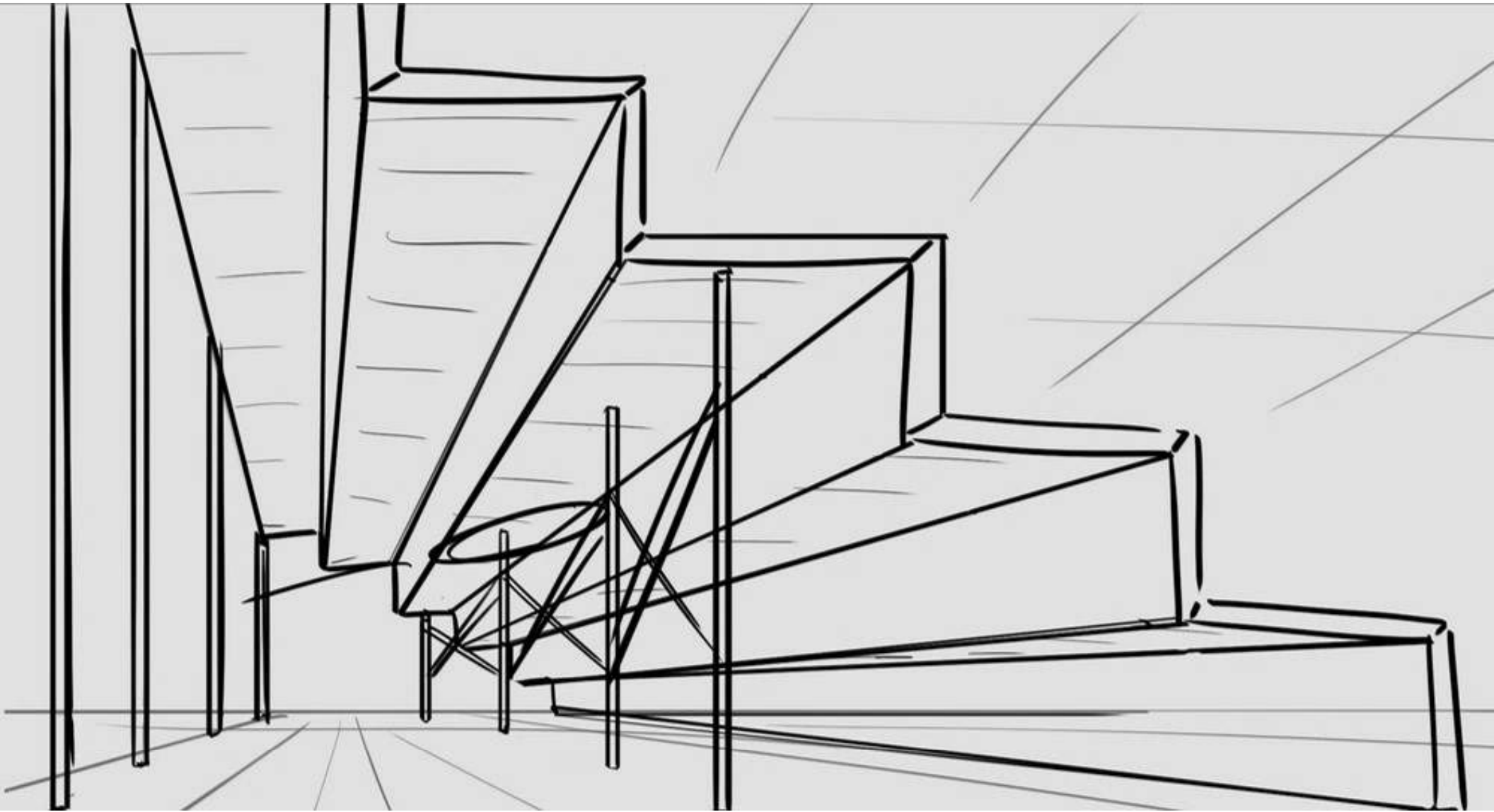

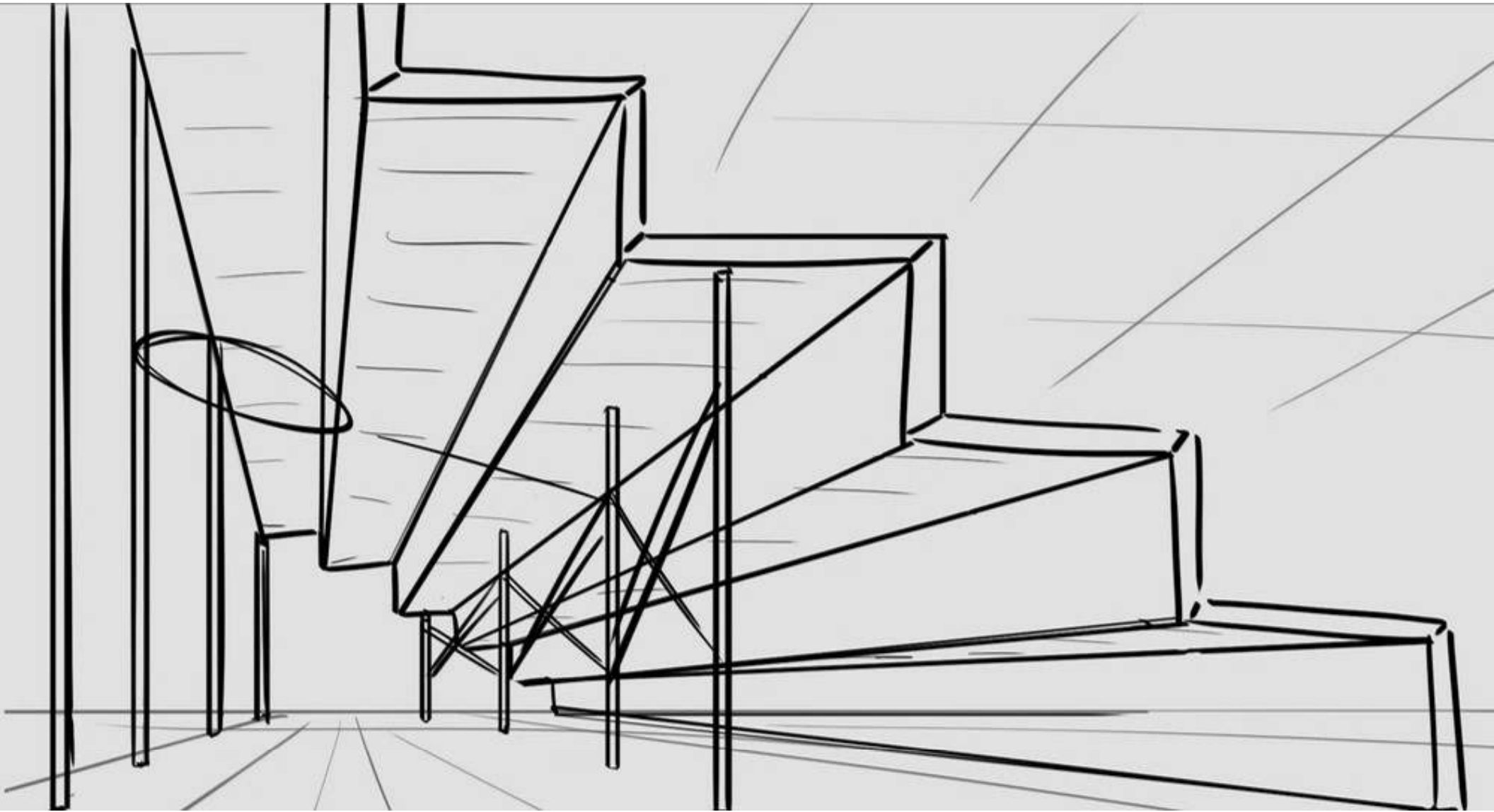

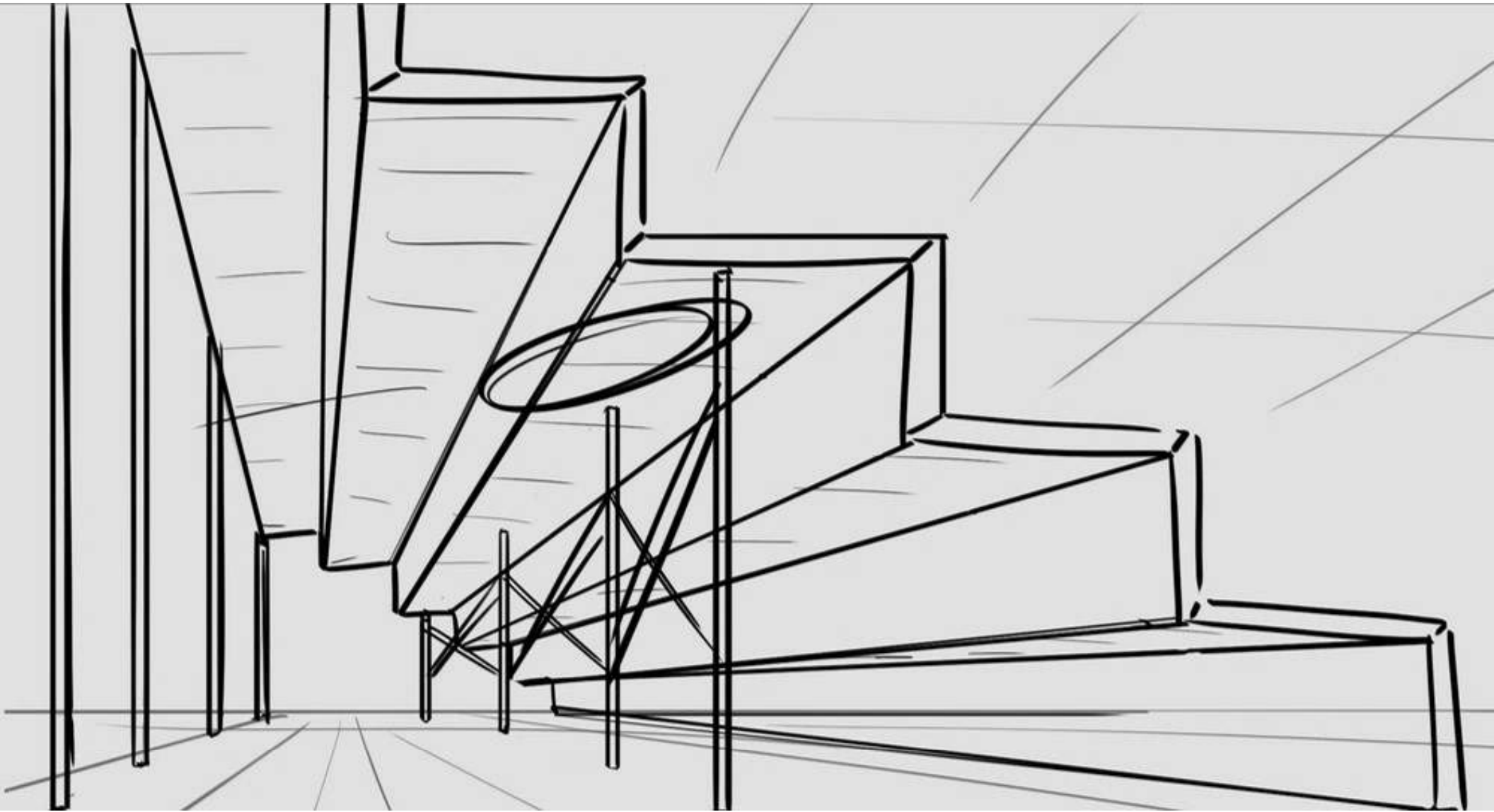

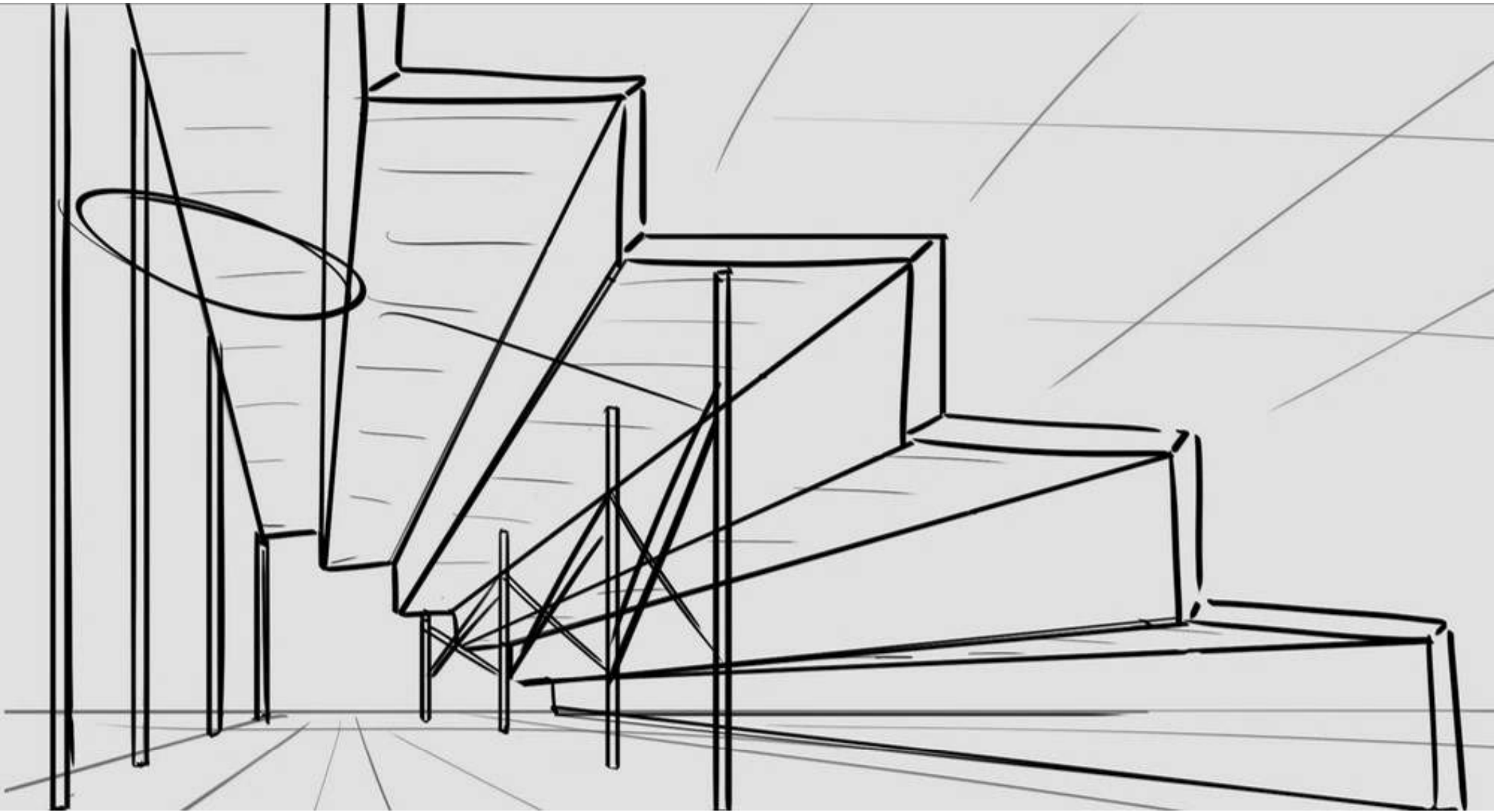

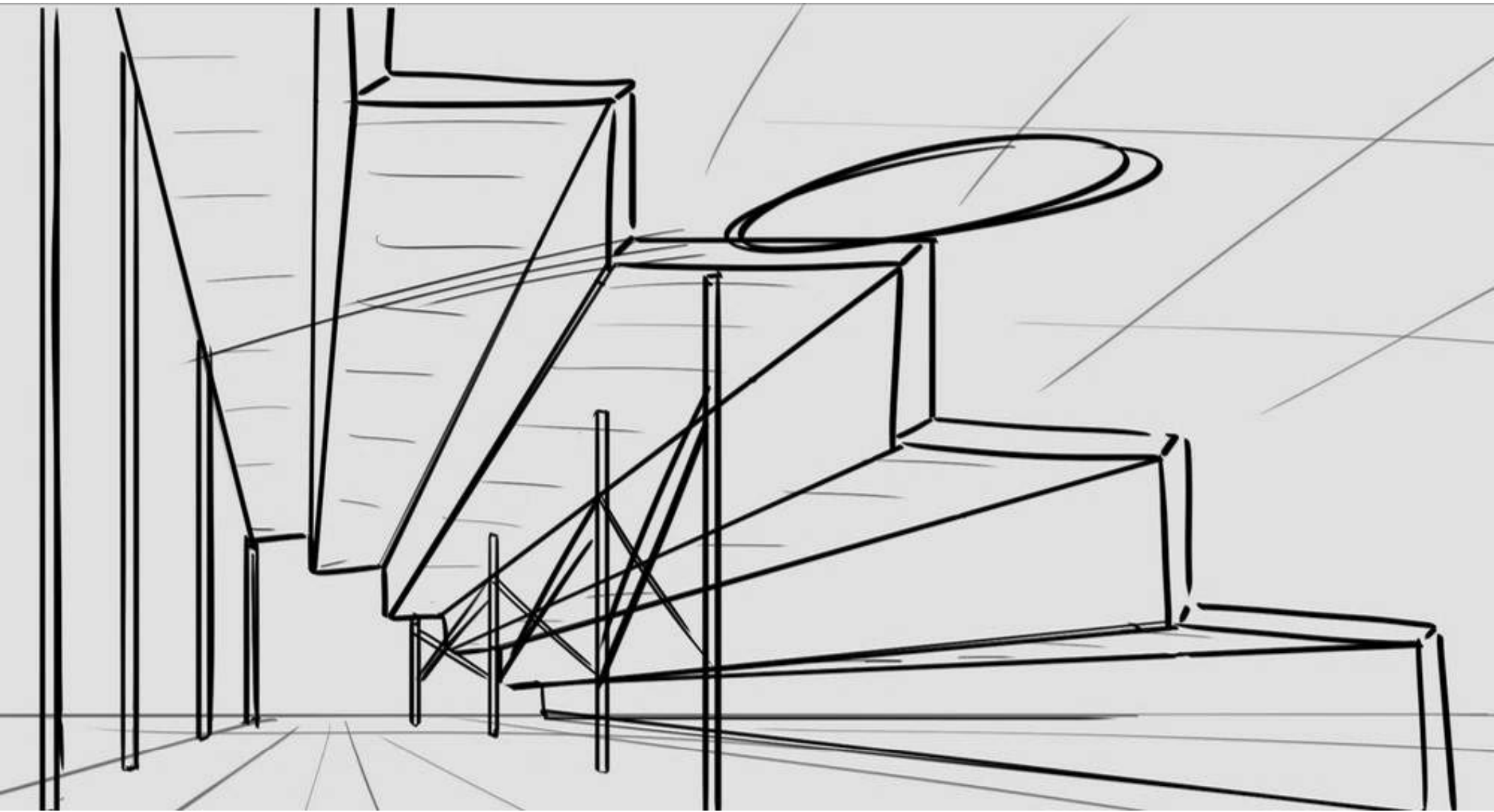

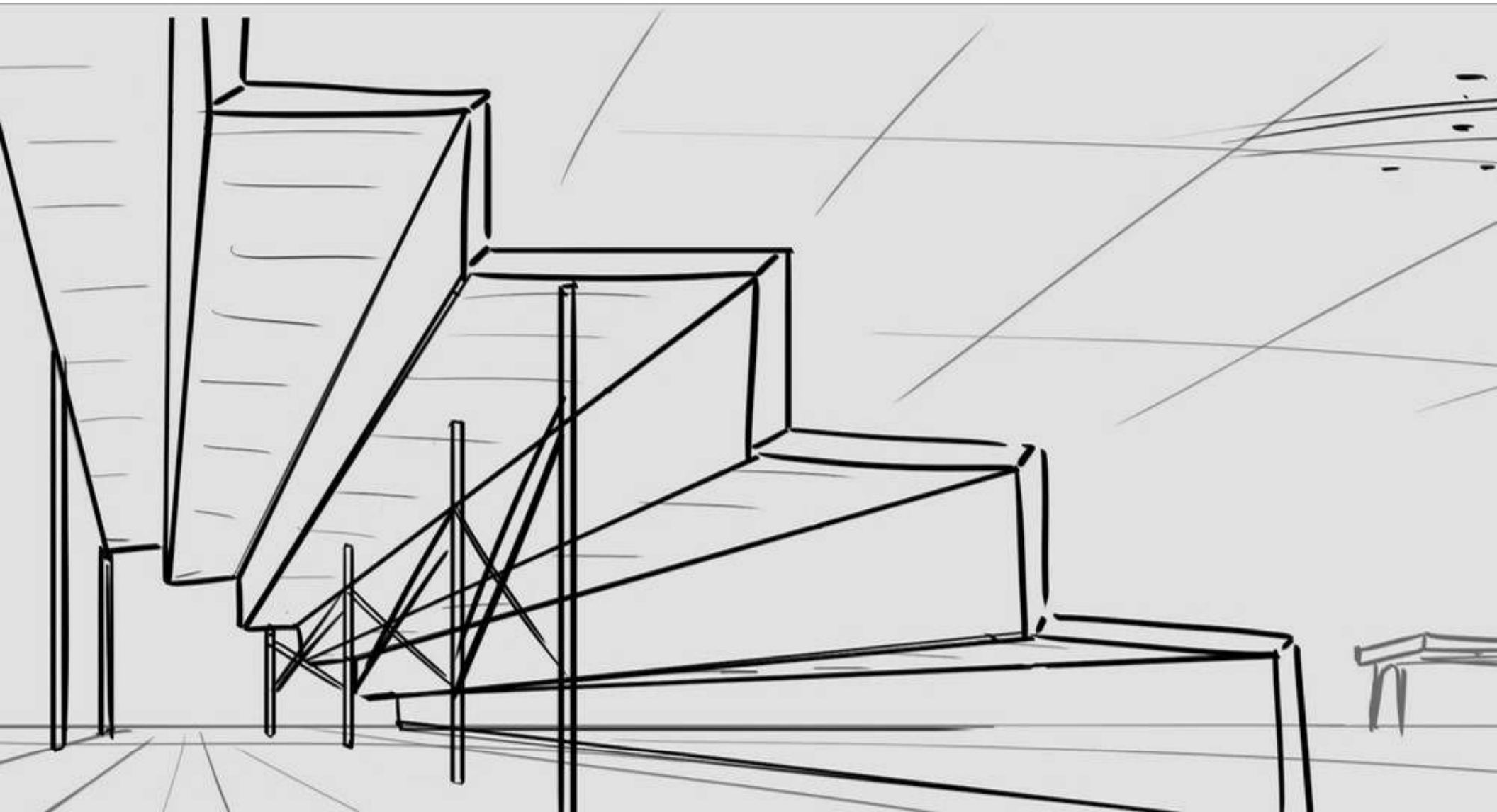

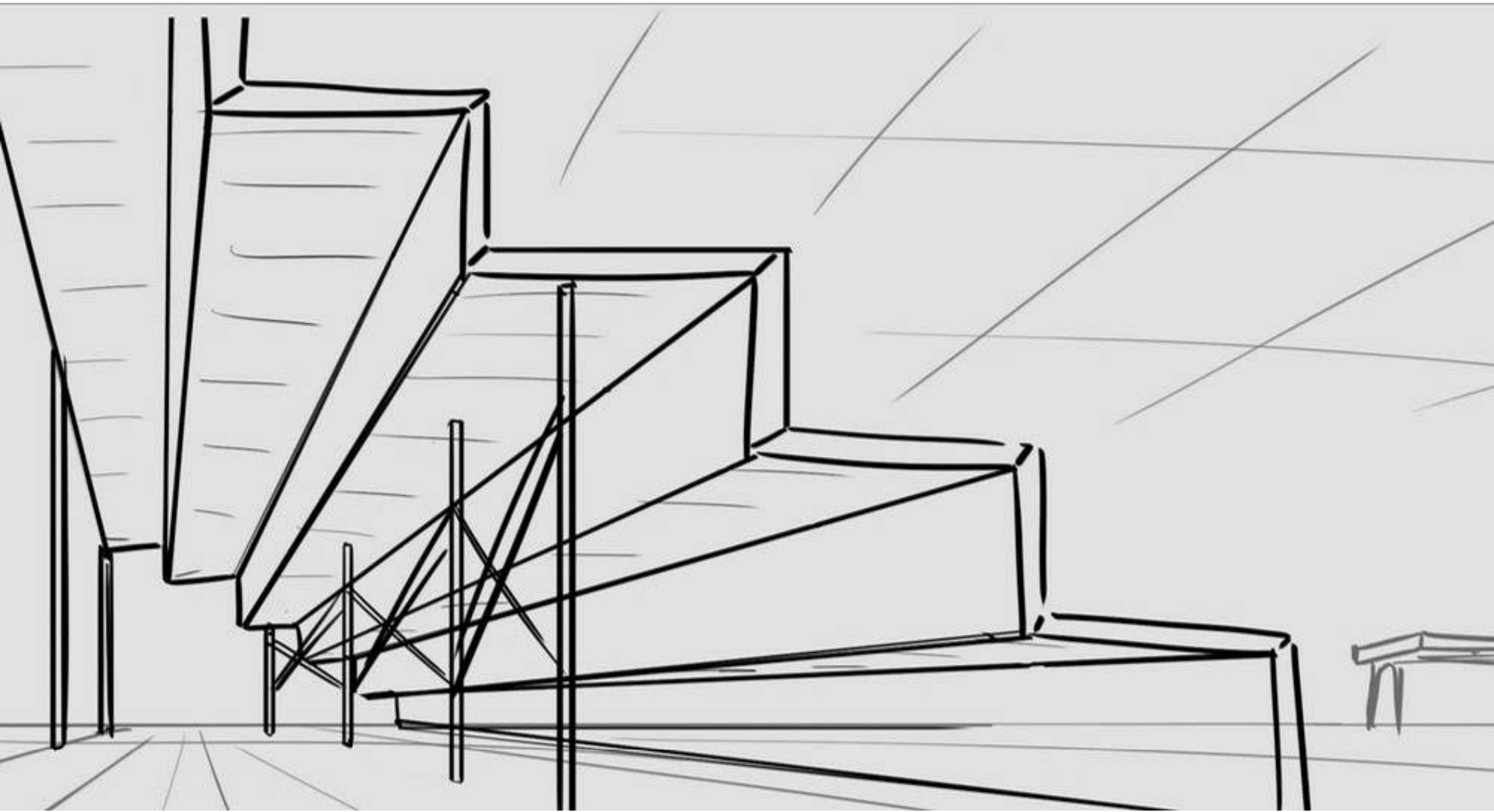

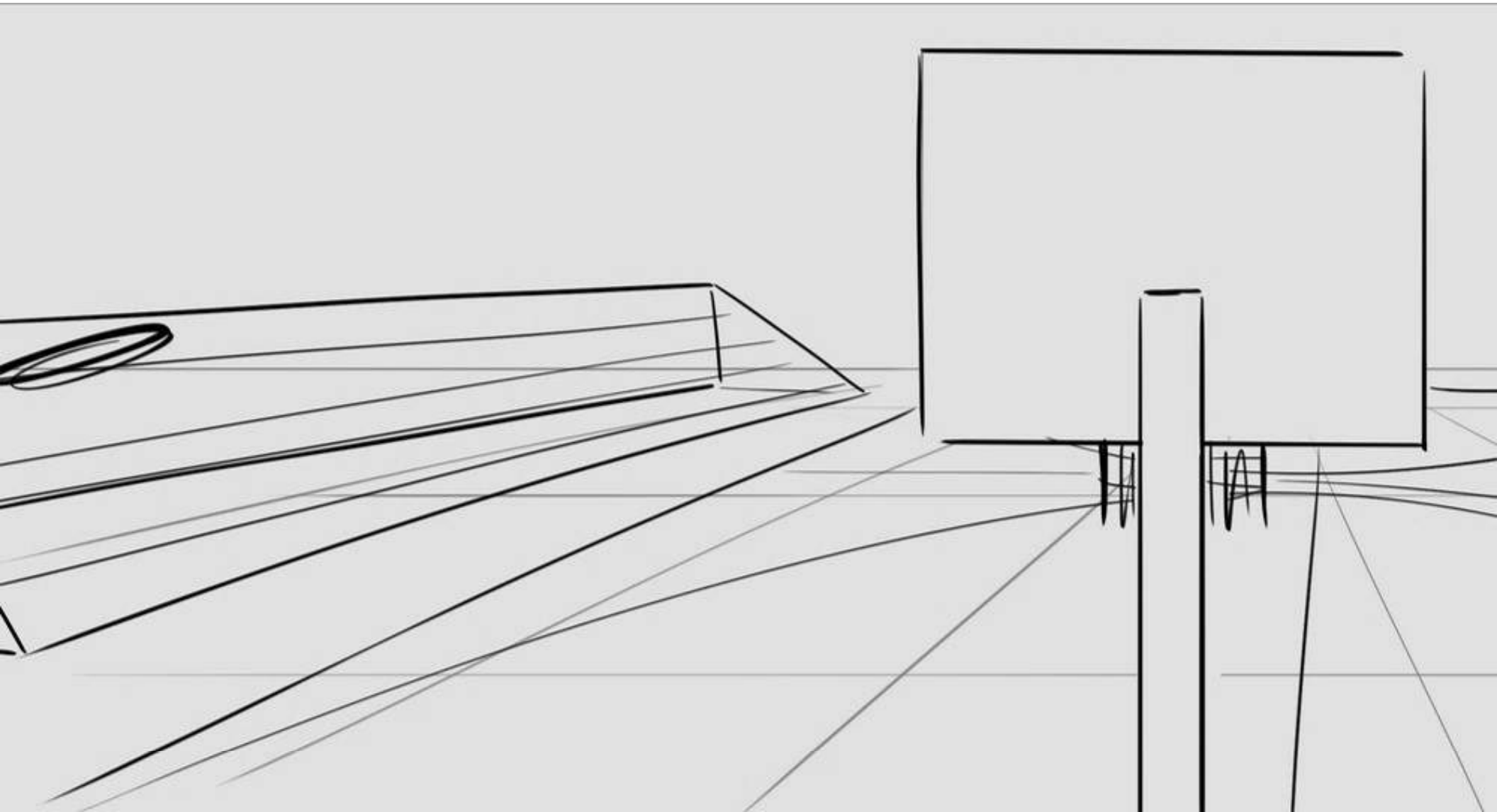

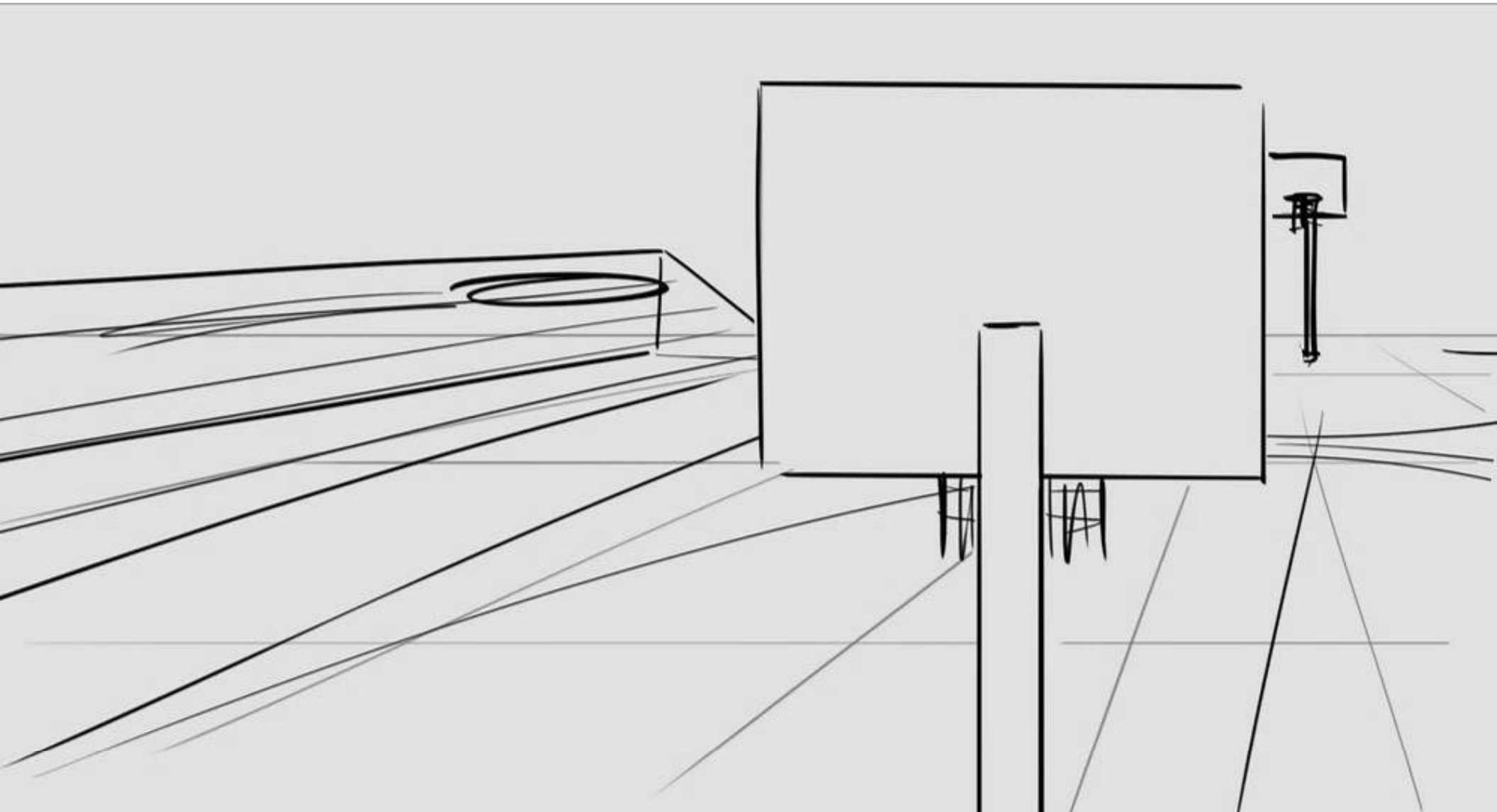

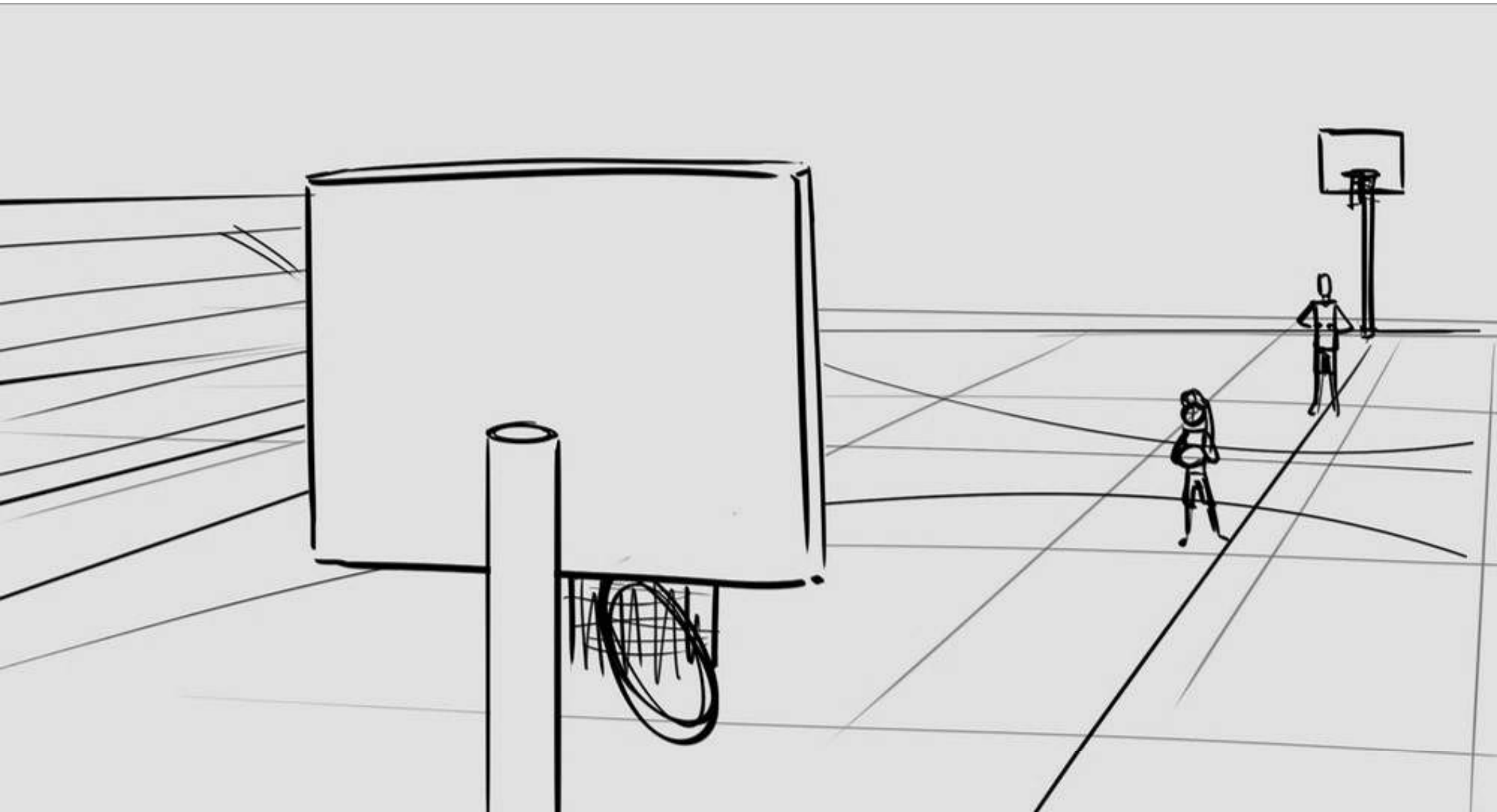

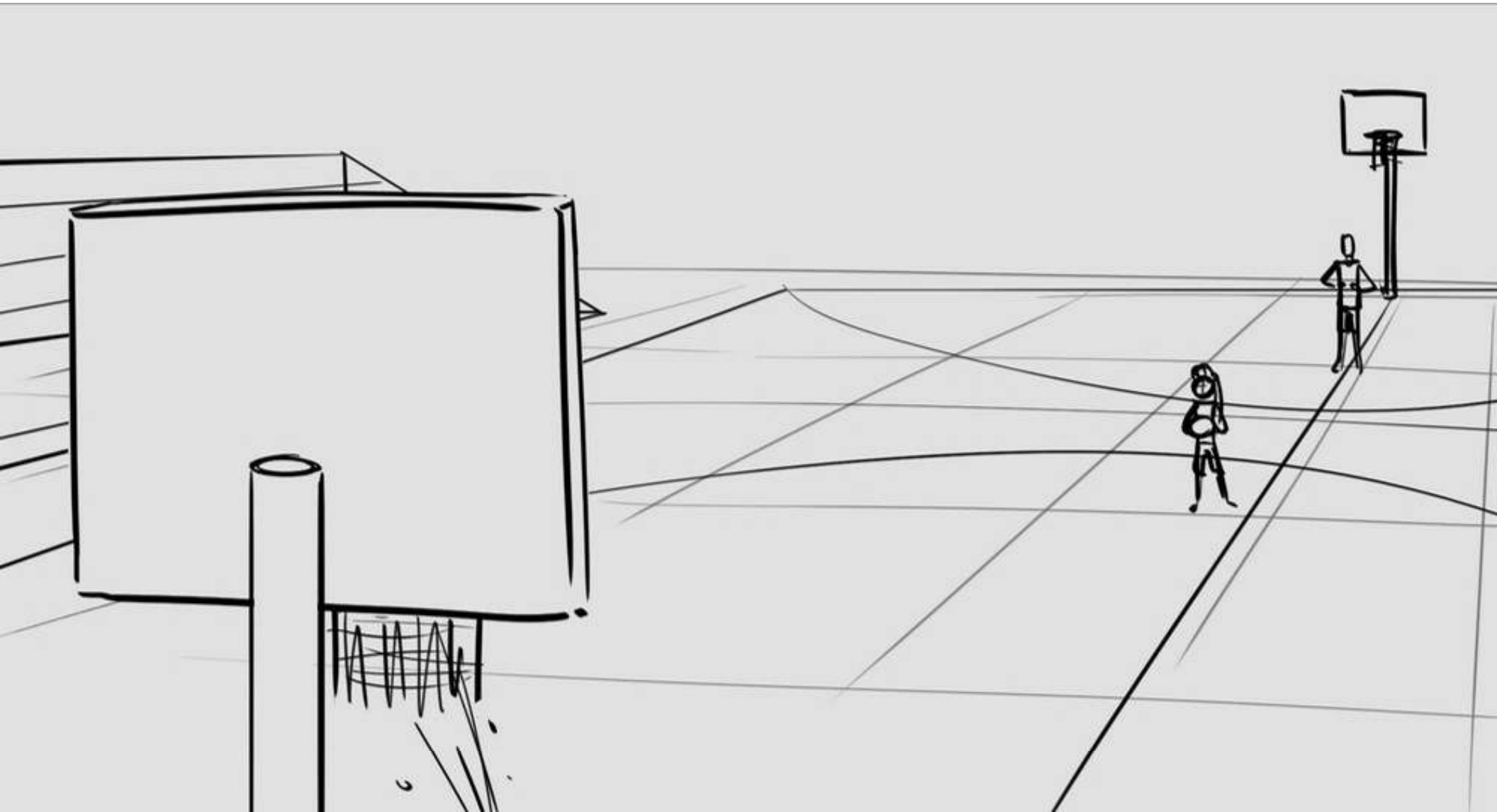

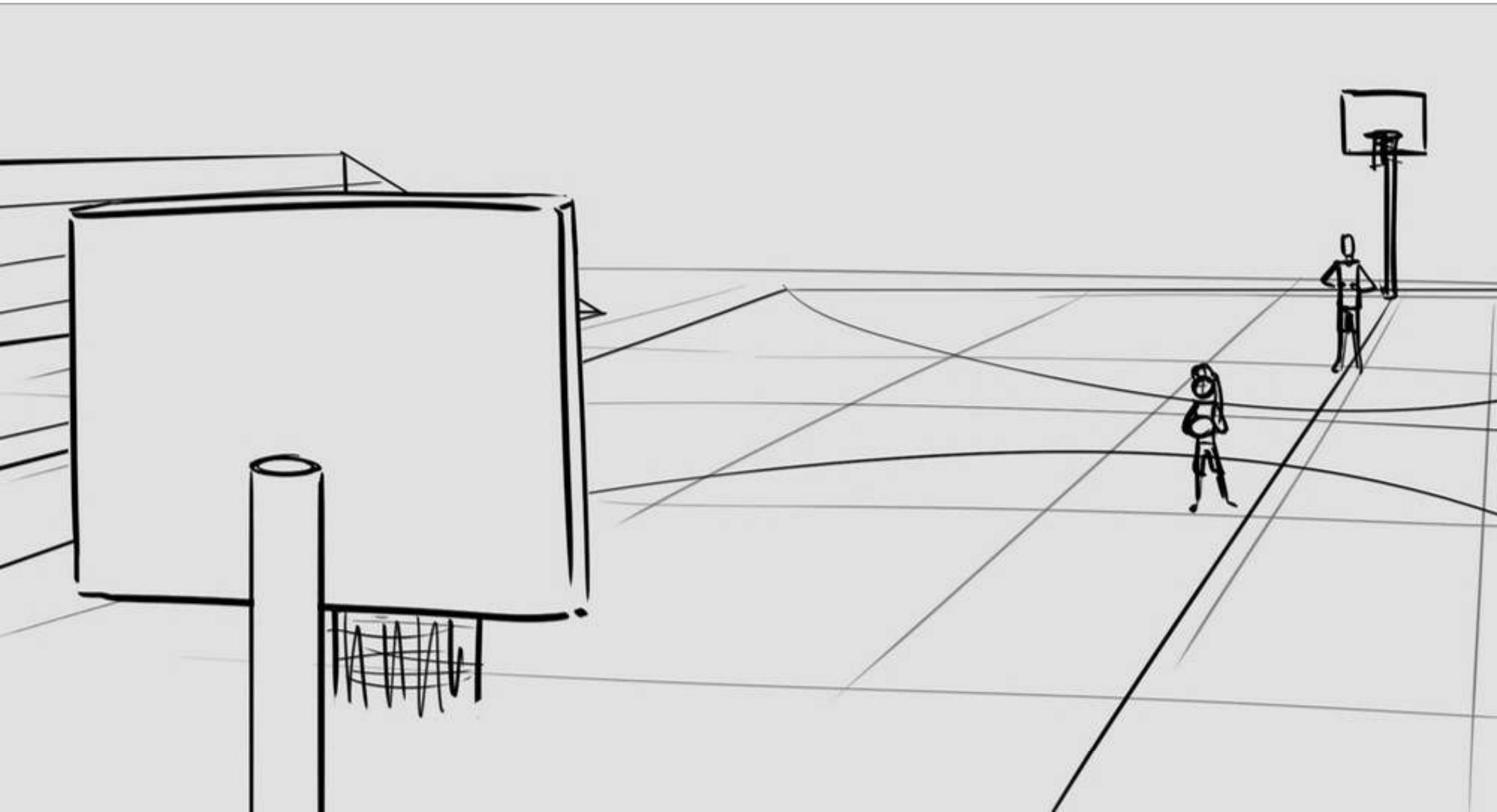

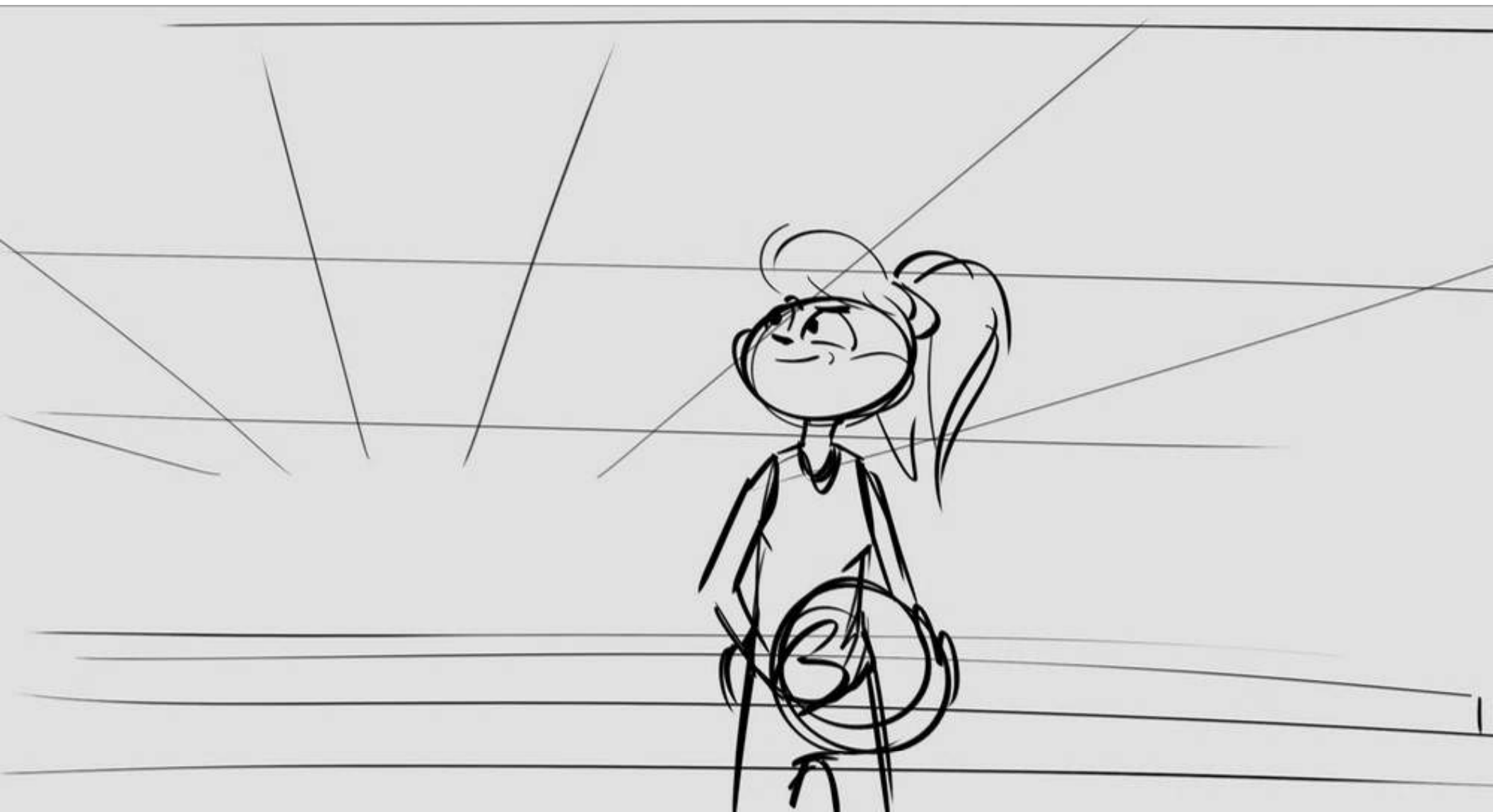

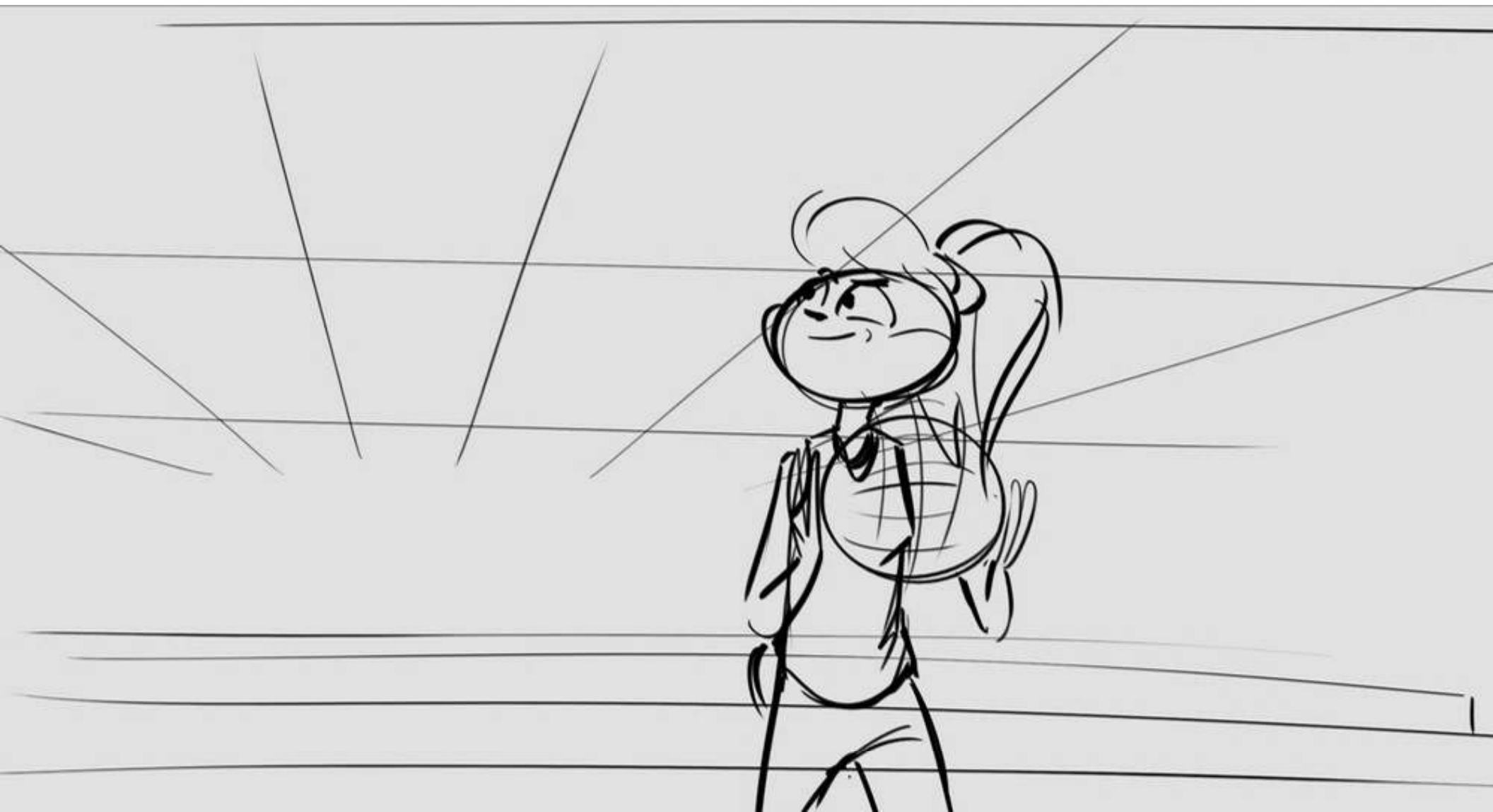

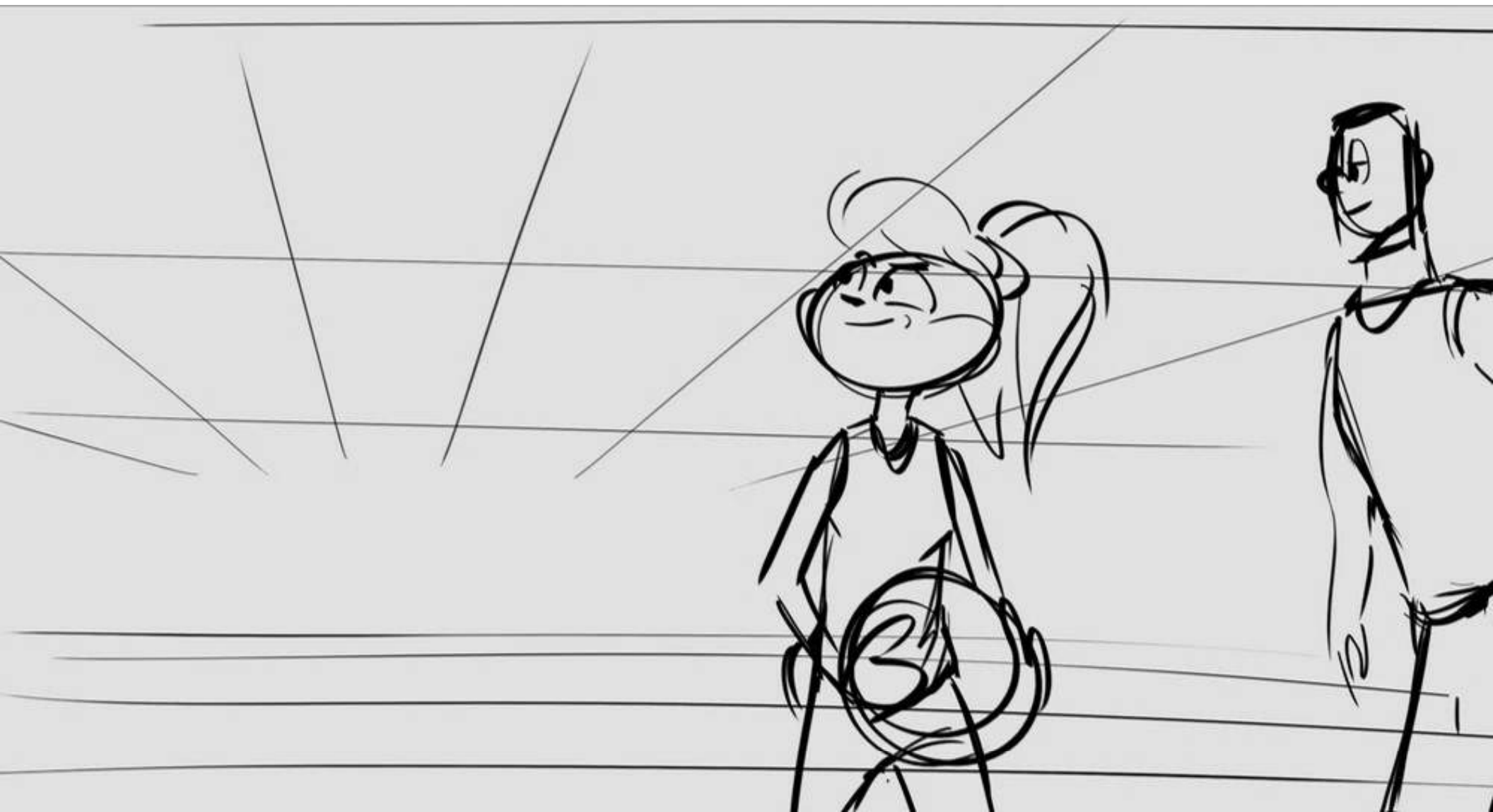

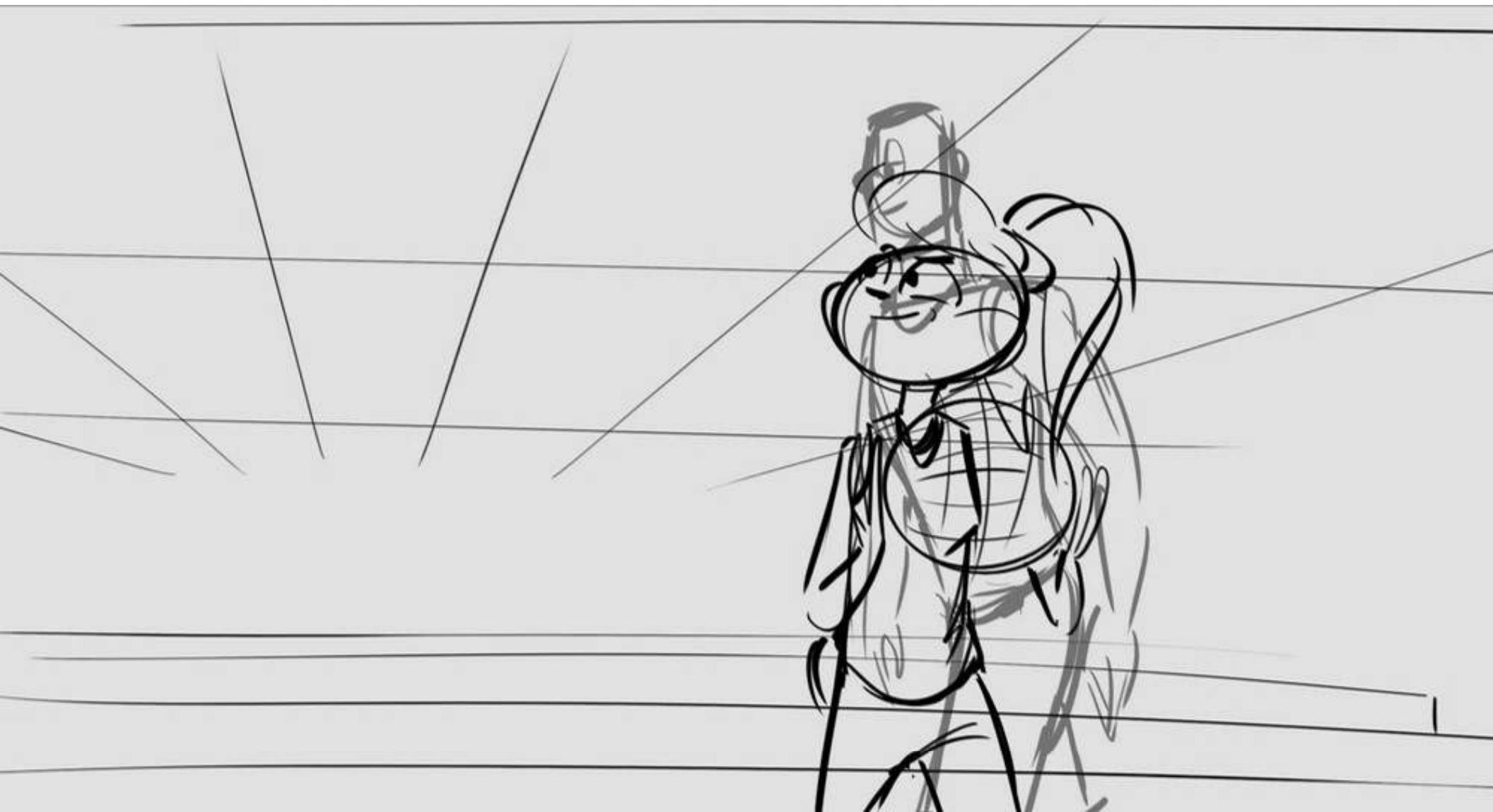



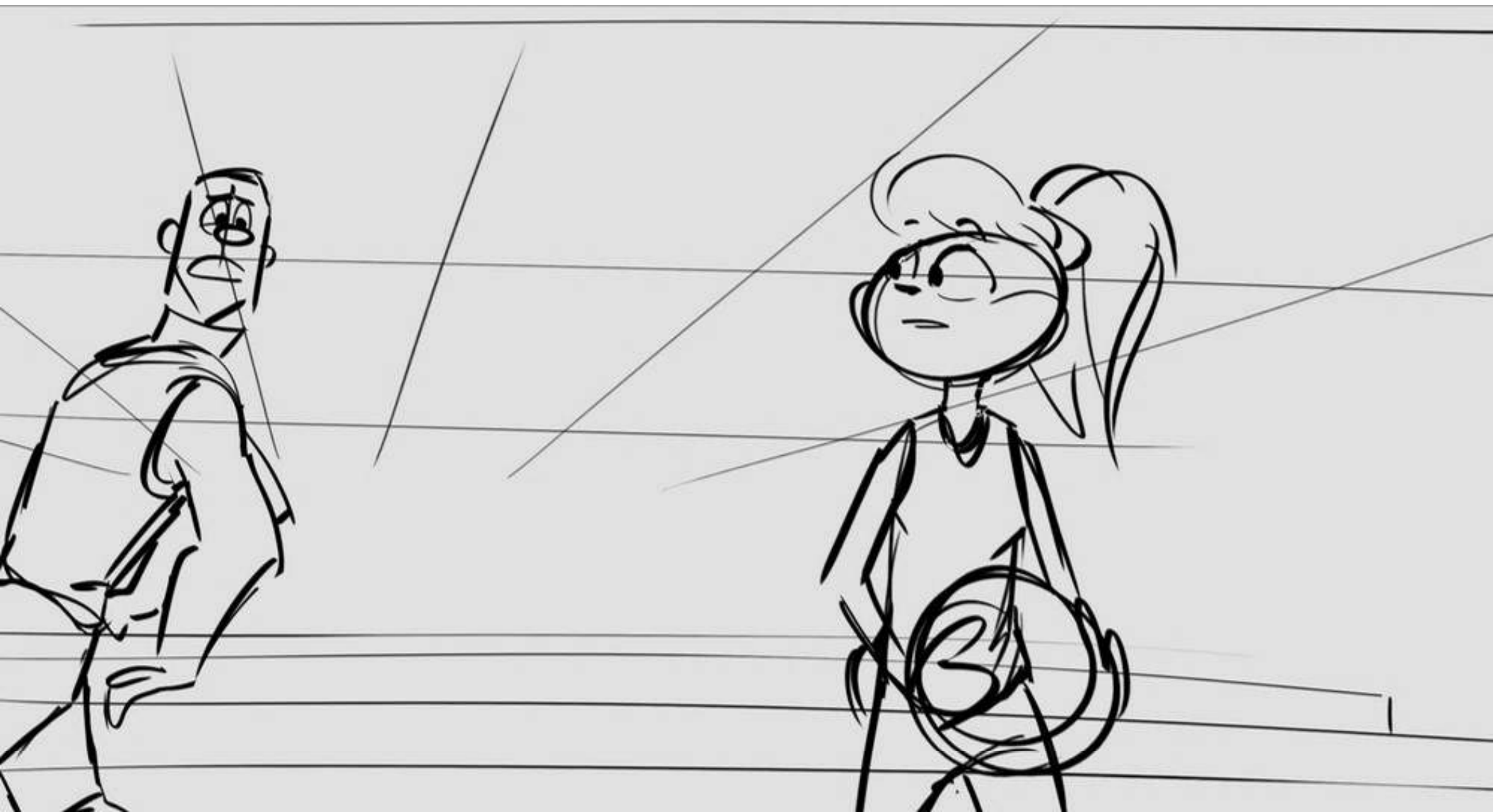

LEBRON: He dressed me up as Elmer Fudd.

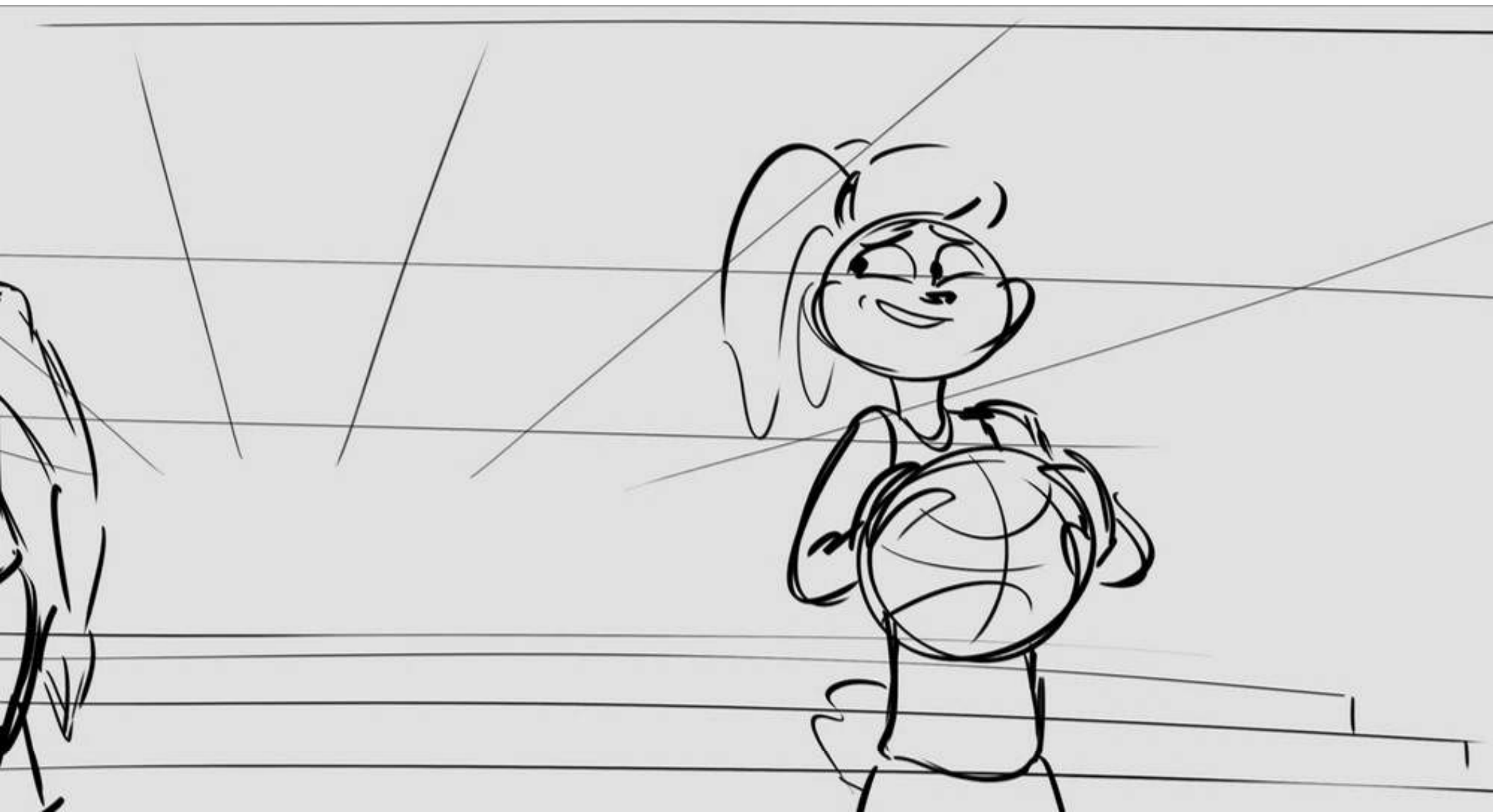

LOLA: Yikes



LOLA: That's Bugs.

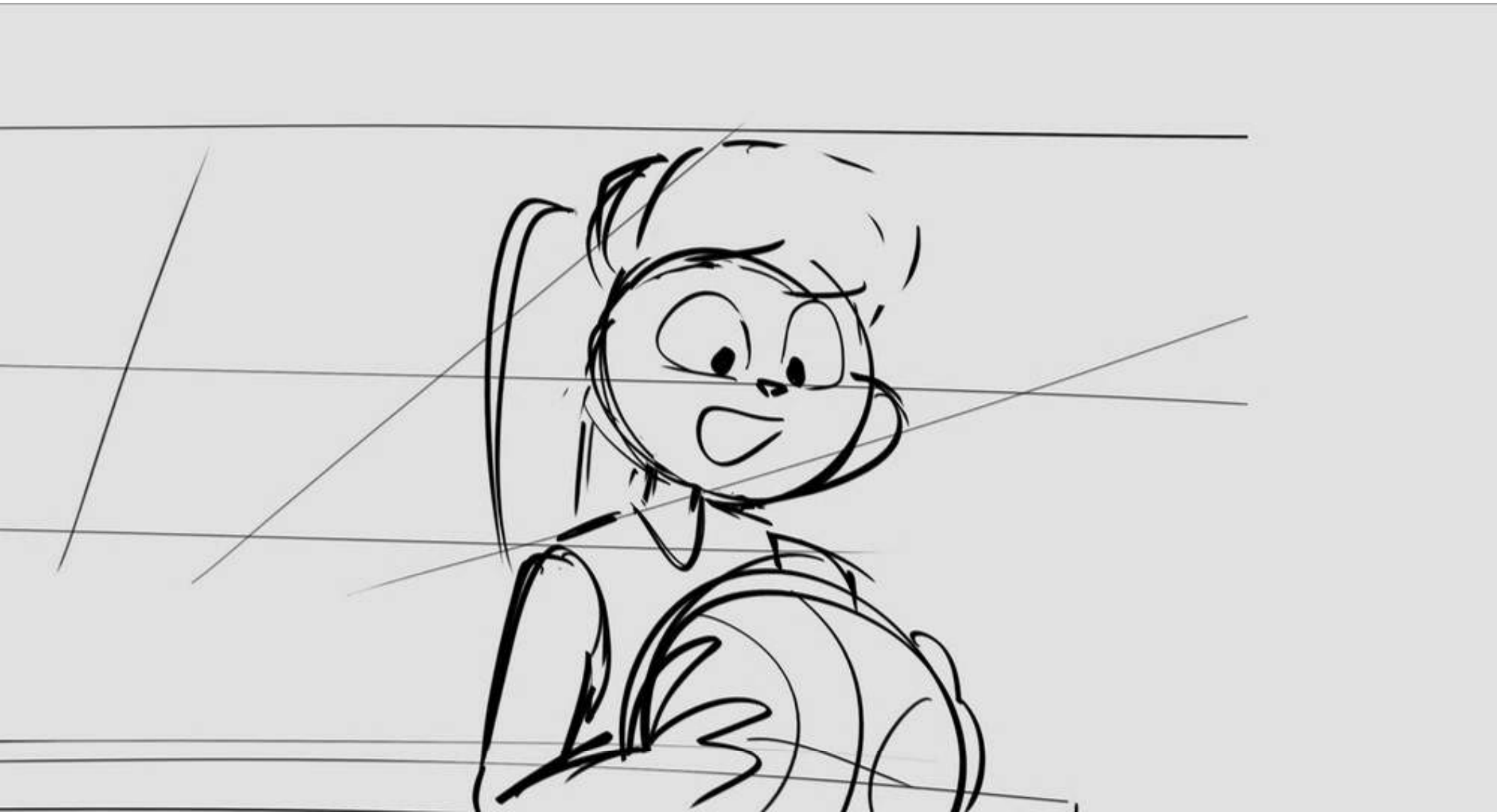

LOLA: That's Bugs.

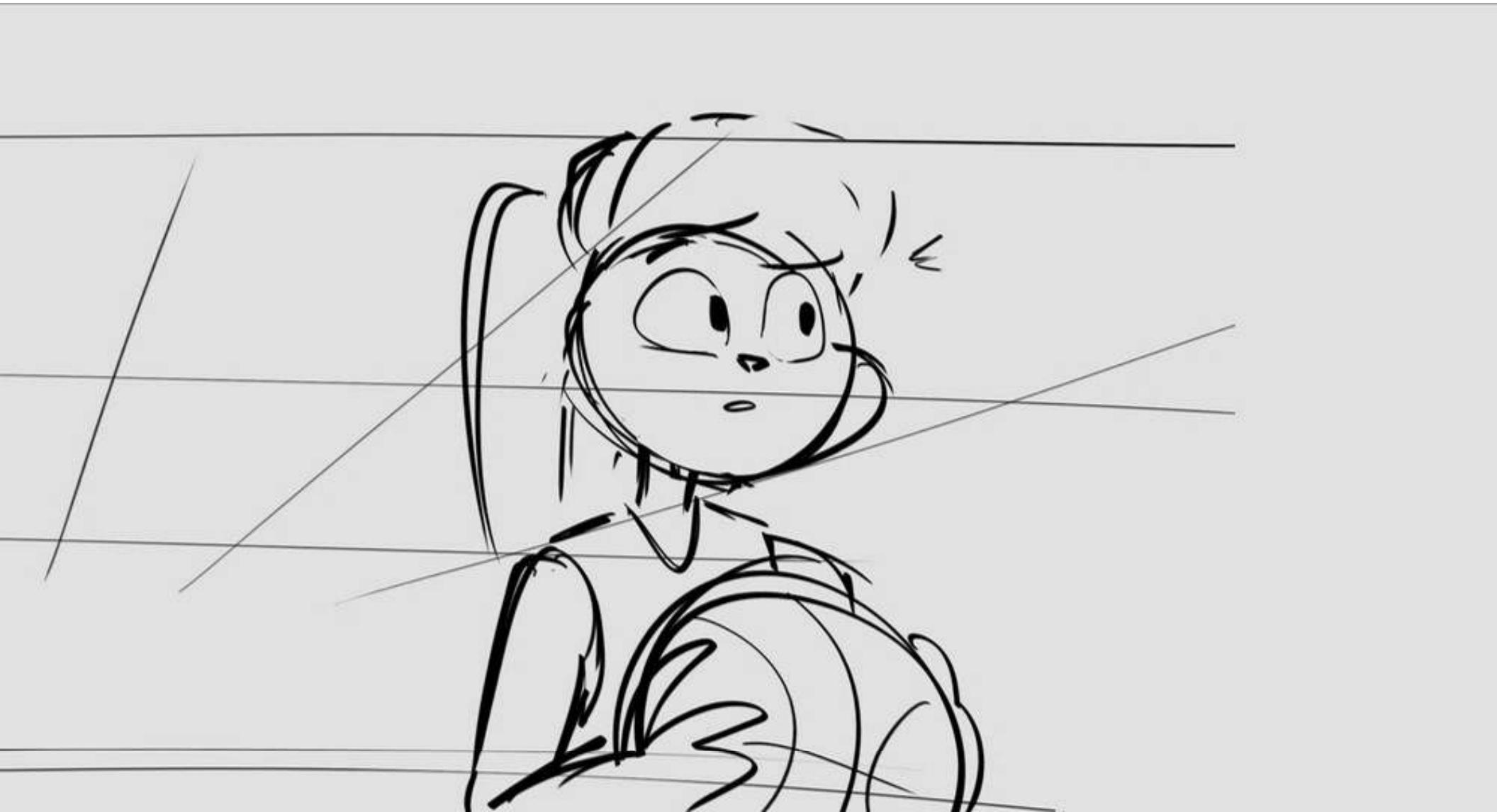

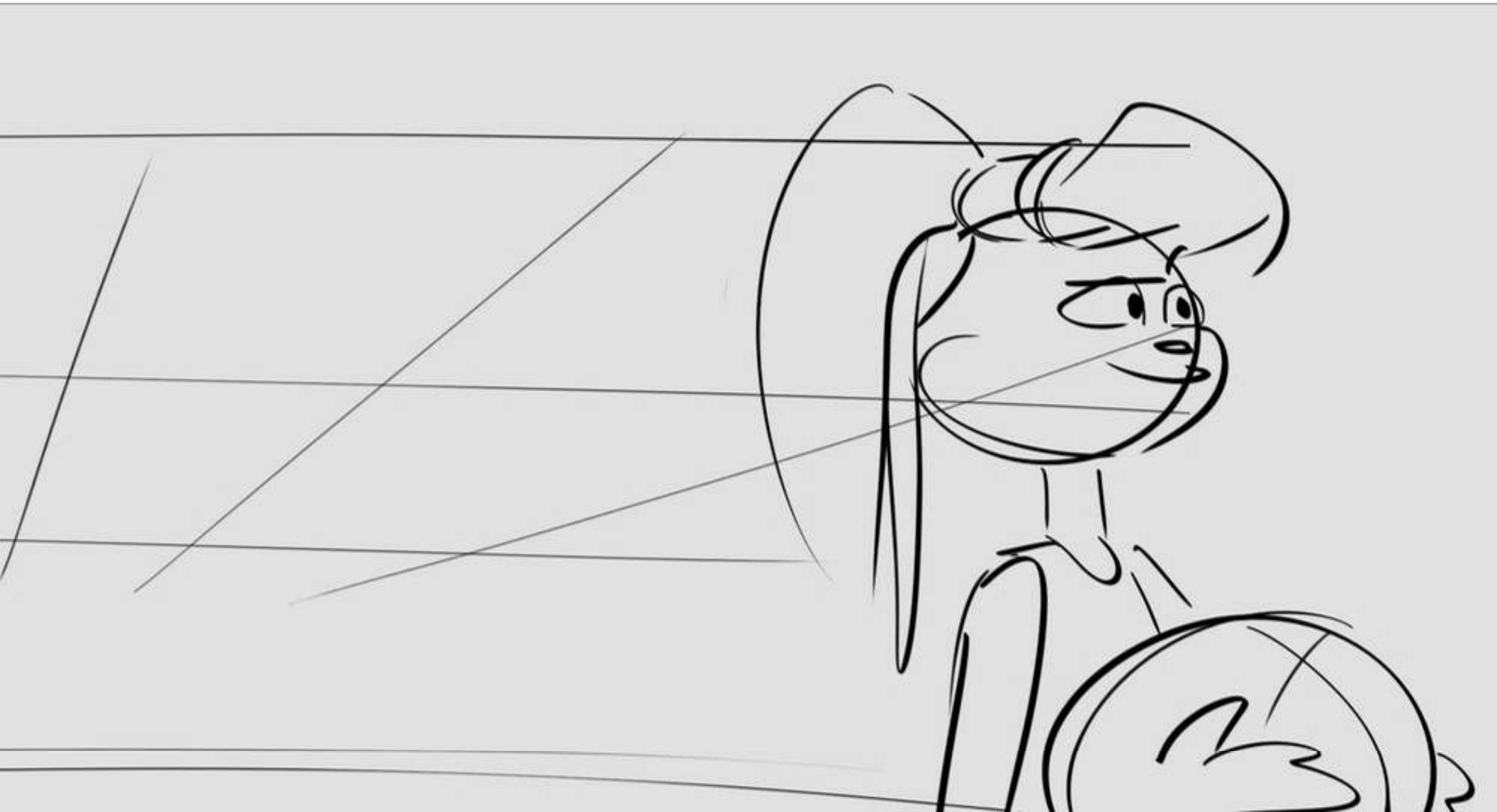

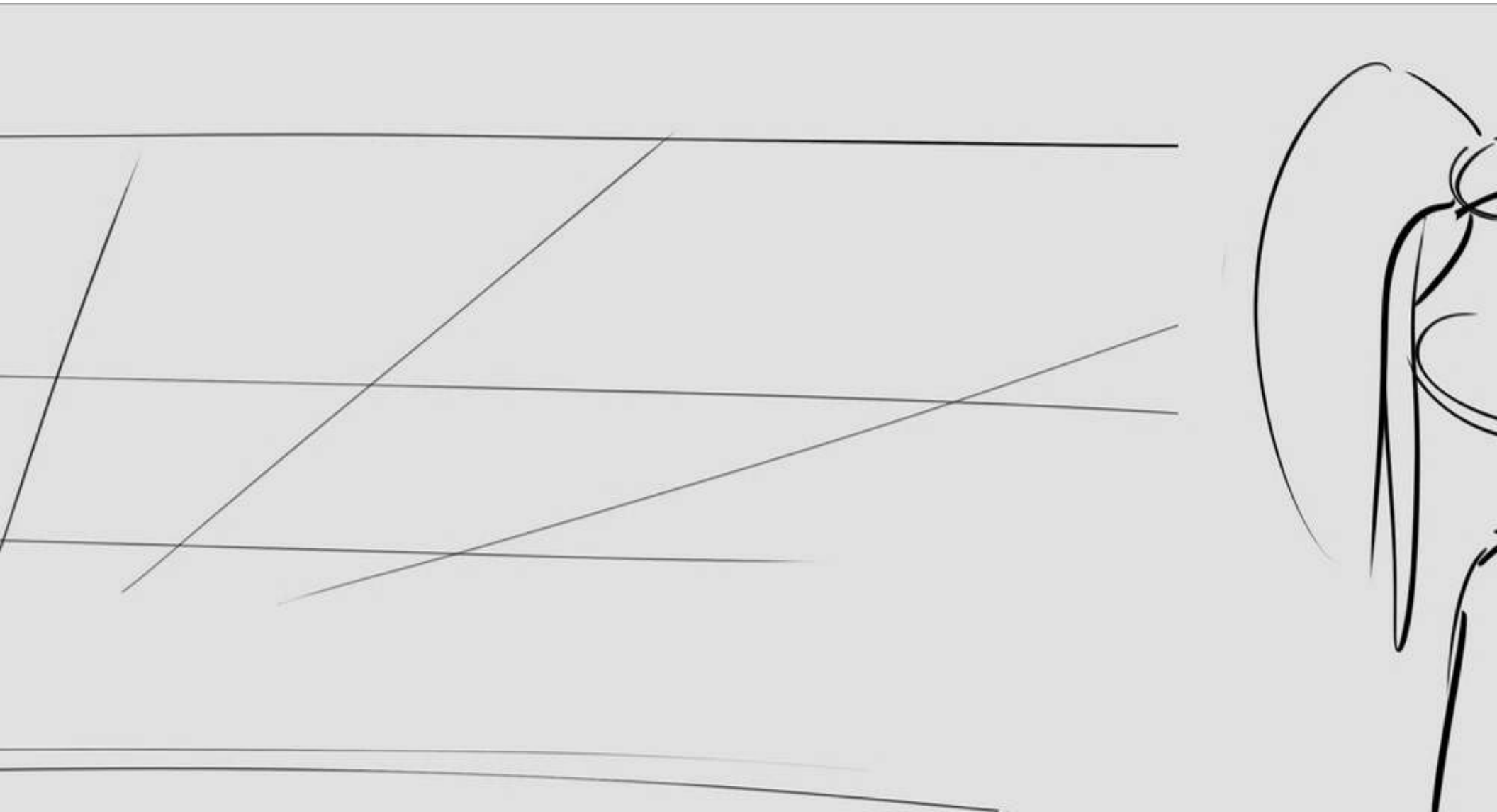

LEBRON (OS): Tell me about it.

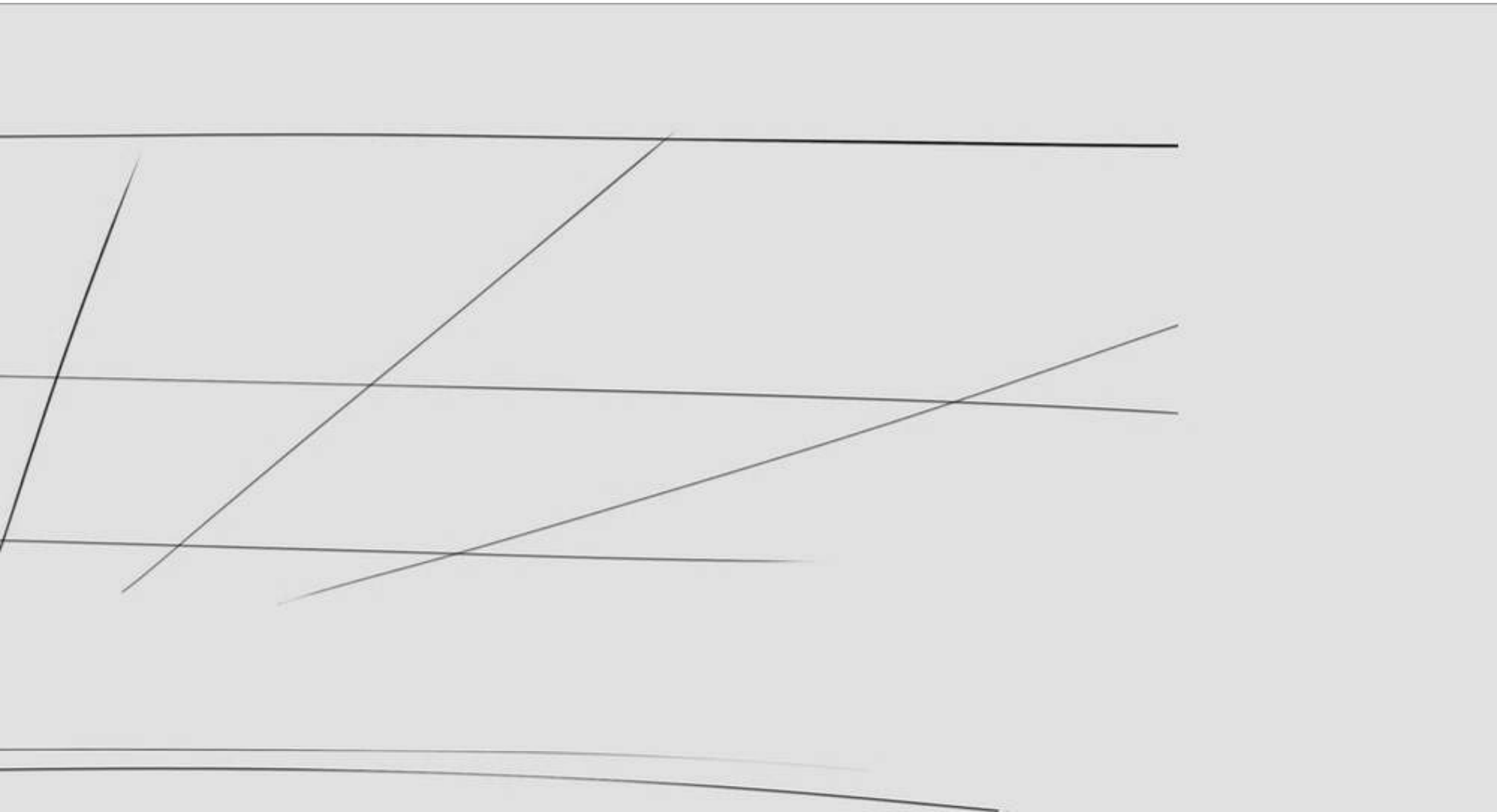

LEBRON (OS): Tell me about it.

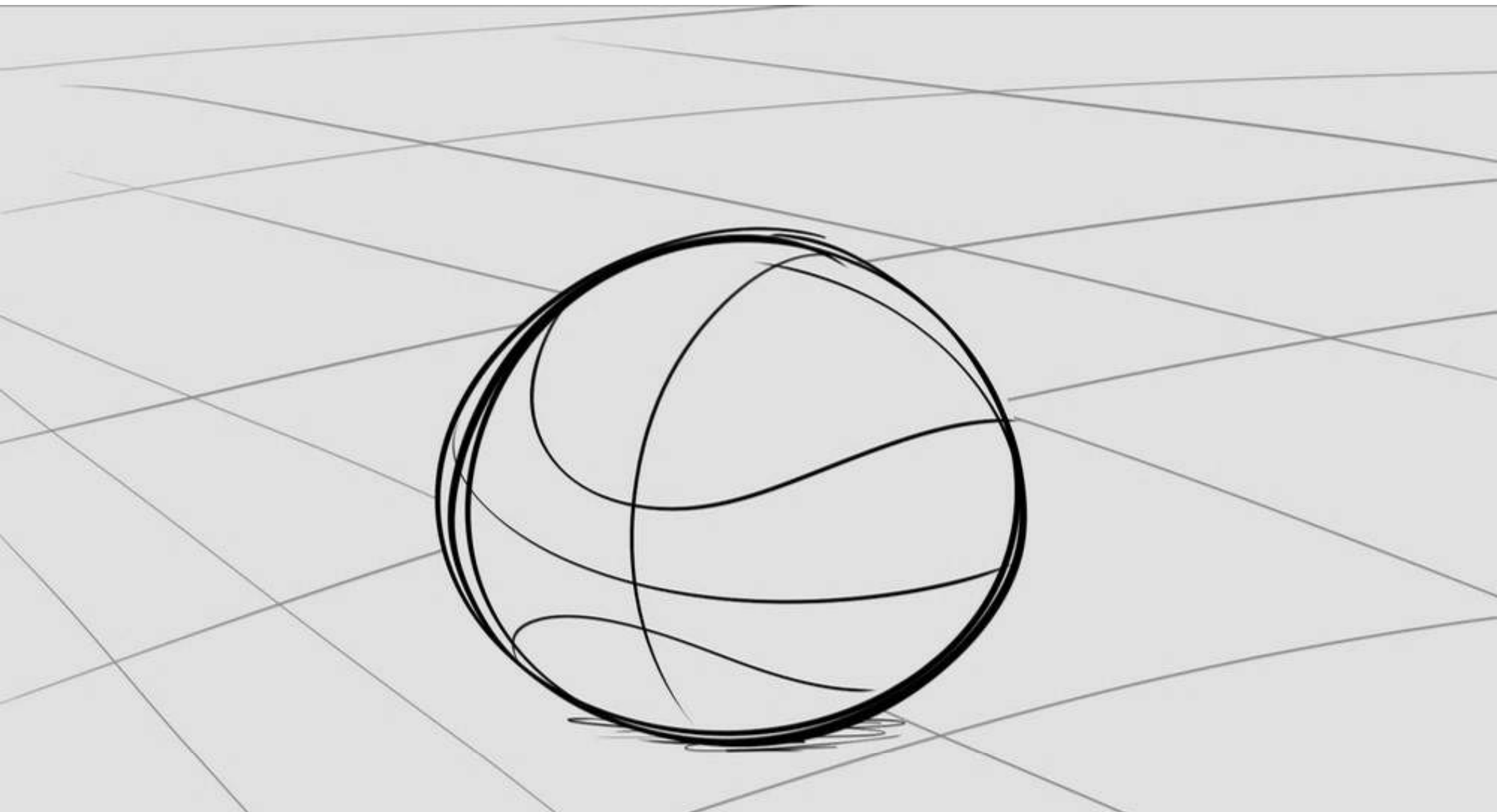

LEBRON: I have to win this game.

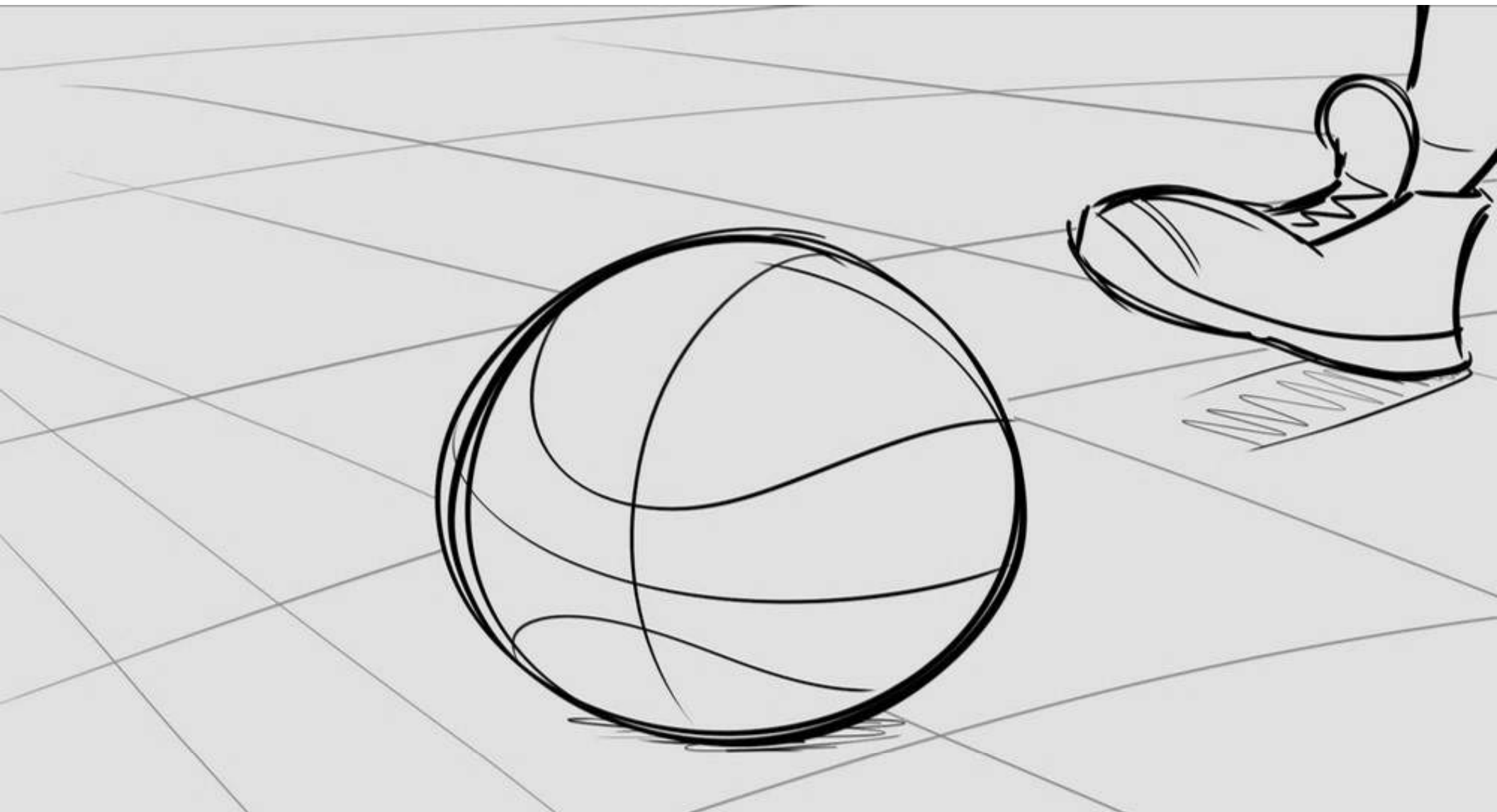

LEBRON: I have to win this game.



LEBRON: I have to win this game.



LEBRON: And to him it's just...games.



LEBRON: And to him it's just...games.





LOLA: Trust me, LeBron.



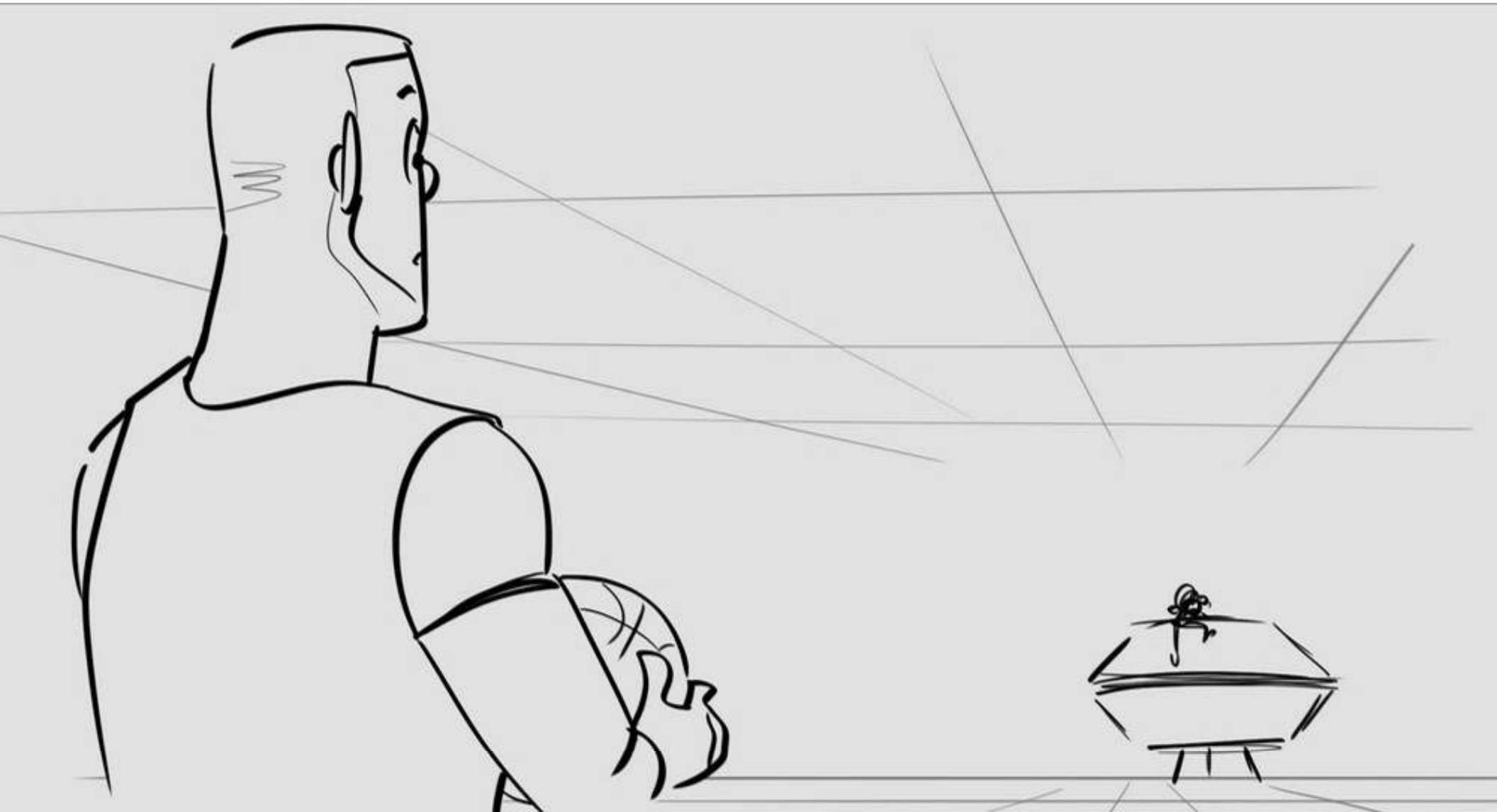

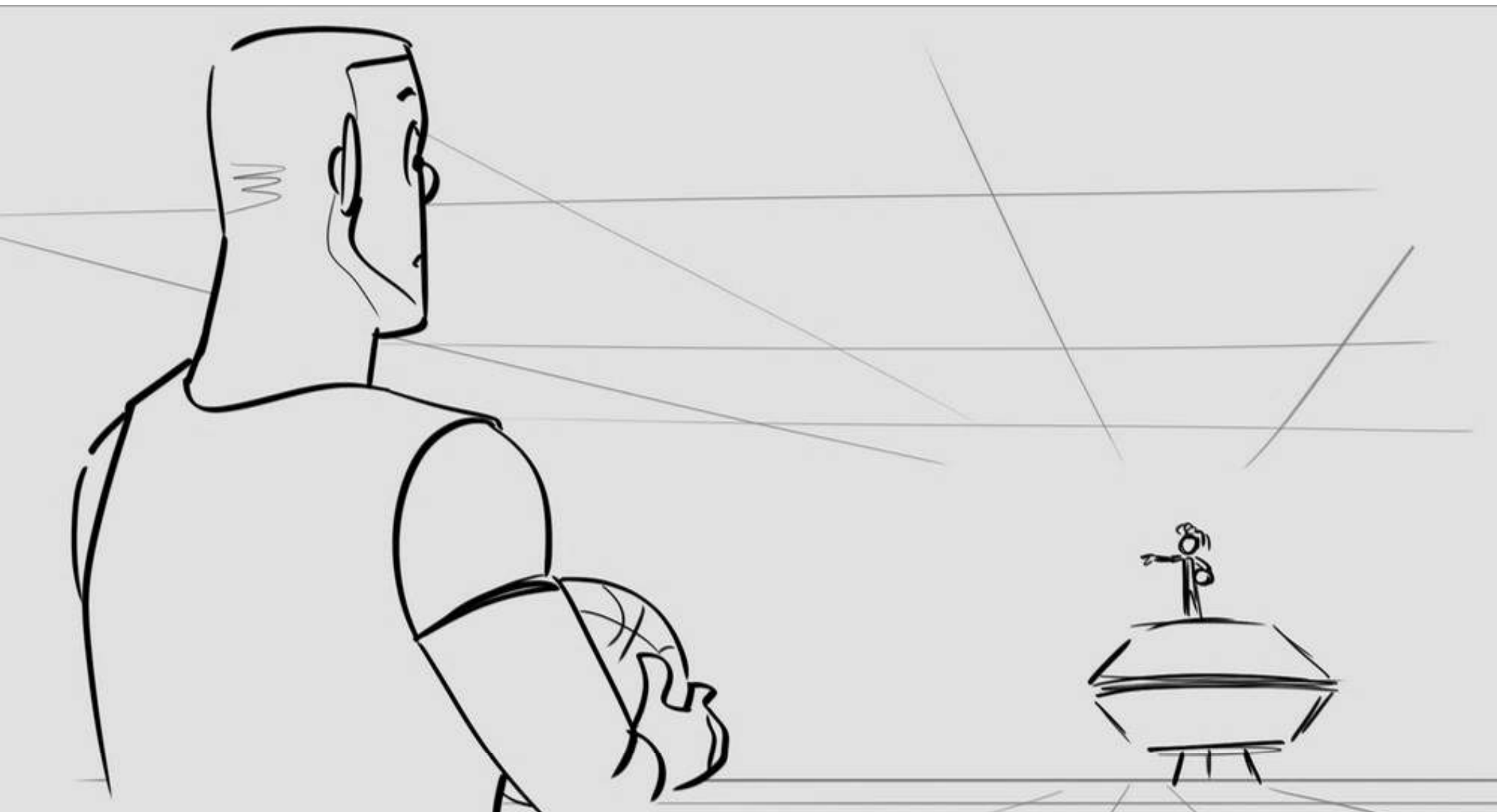

LOLA: I get it.



LOLA: Bugs says he wants to help.



LOLA: Bugs says he wants to help.
SFX: basketball bouncing progressively harder and harder



LOLA: Bugs says he wants to help.
SFX: basketball bouncing progressively harder and harder

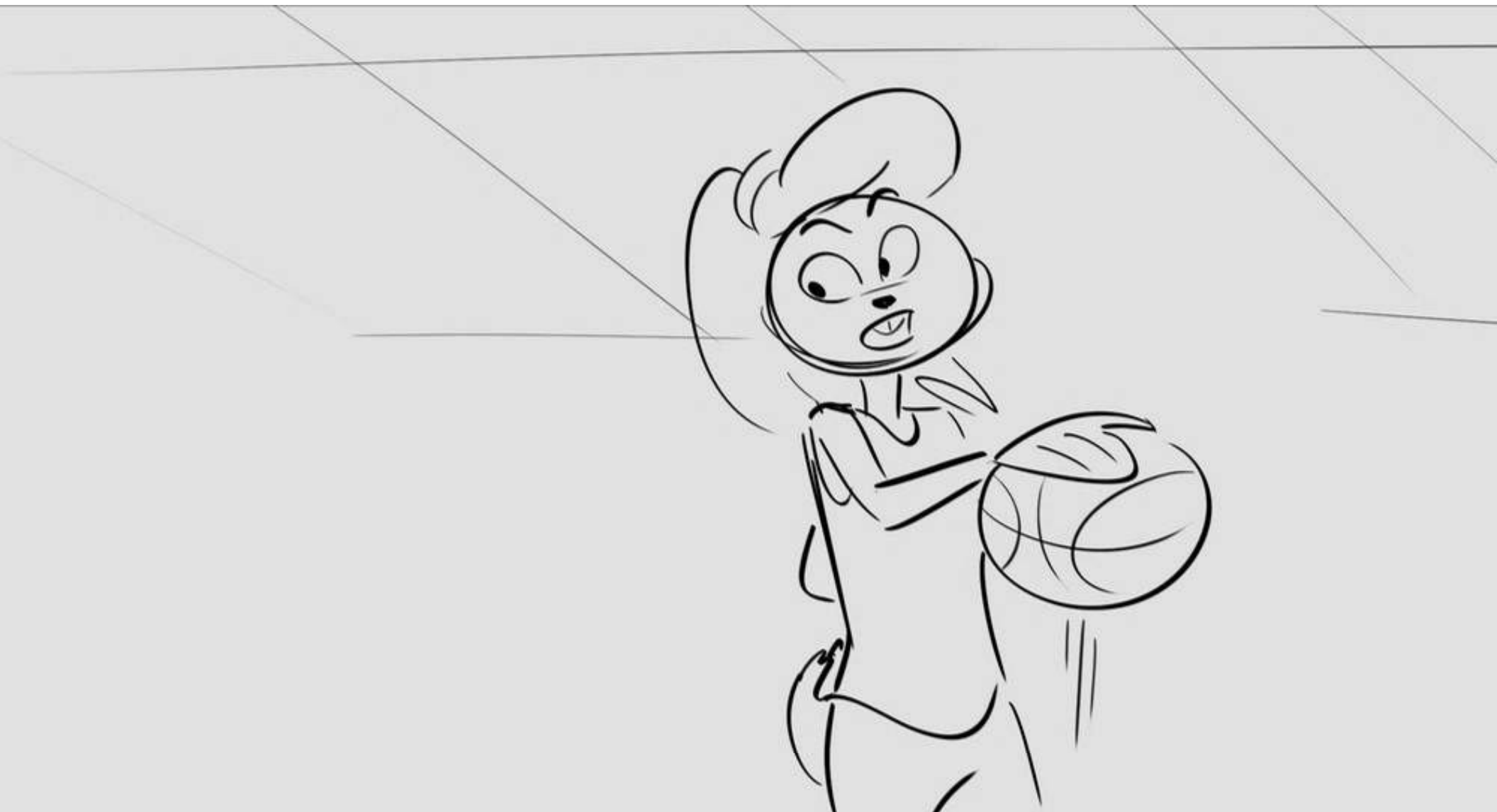

LOLA: He SAYS he wants to be a team player.
SFX: basketball bouncing progressively harder and harder



LOLA: He SAYS he wants to be a team player.
SFX: basketball bouncing progressively harder and harder



LOLA: He SAYS he wants to be a team player.
SFX: basketball bouncing progressively harder and harder



LOLA: But at the end of the day
SFX: basketball bouncing progressively harder and harder



LOLA: But at the end of the day
SFX: basketball bouncing progressively harder and harder



LOLA: But at the end of the day
SFX: basketball bouncing progressively harder and harder



LOLA: But at the end of the day
SFX: basketball bouncing progressively harder and harder



LOLA: It's always the Bugs Bunny show.
SFX: basketball bouncing progressively harder and harder



LOLA: It's always the Bugs Bunny show.
SFX: basketball bouncing progressively harder and harder



LOLA: It's always the Bugs Bunny show.
SFX: basketball bouncing progressively harder and harder



LOLA: It's always the Bugs Bunny show.
SFX: basketball bouncing progressively harder and harder



LOLA: It's always the Bugs Bunny show.
SFX: basketball bouncing progressively harder and harder



LOLA: It's always the Bugs Bunny show.
SFX: basketball bouncing progressively harder and harder



LOLA: It's always the Bugs Bunny show.
SFX: basketball bouncing progressively harder and harder











SFX: hissing smoke



SFX: hissing smoke



SFX: hissing smoke

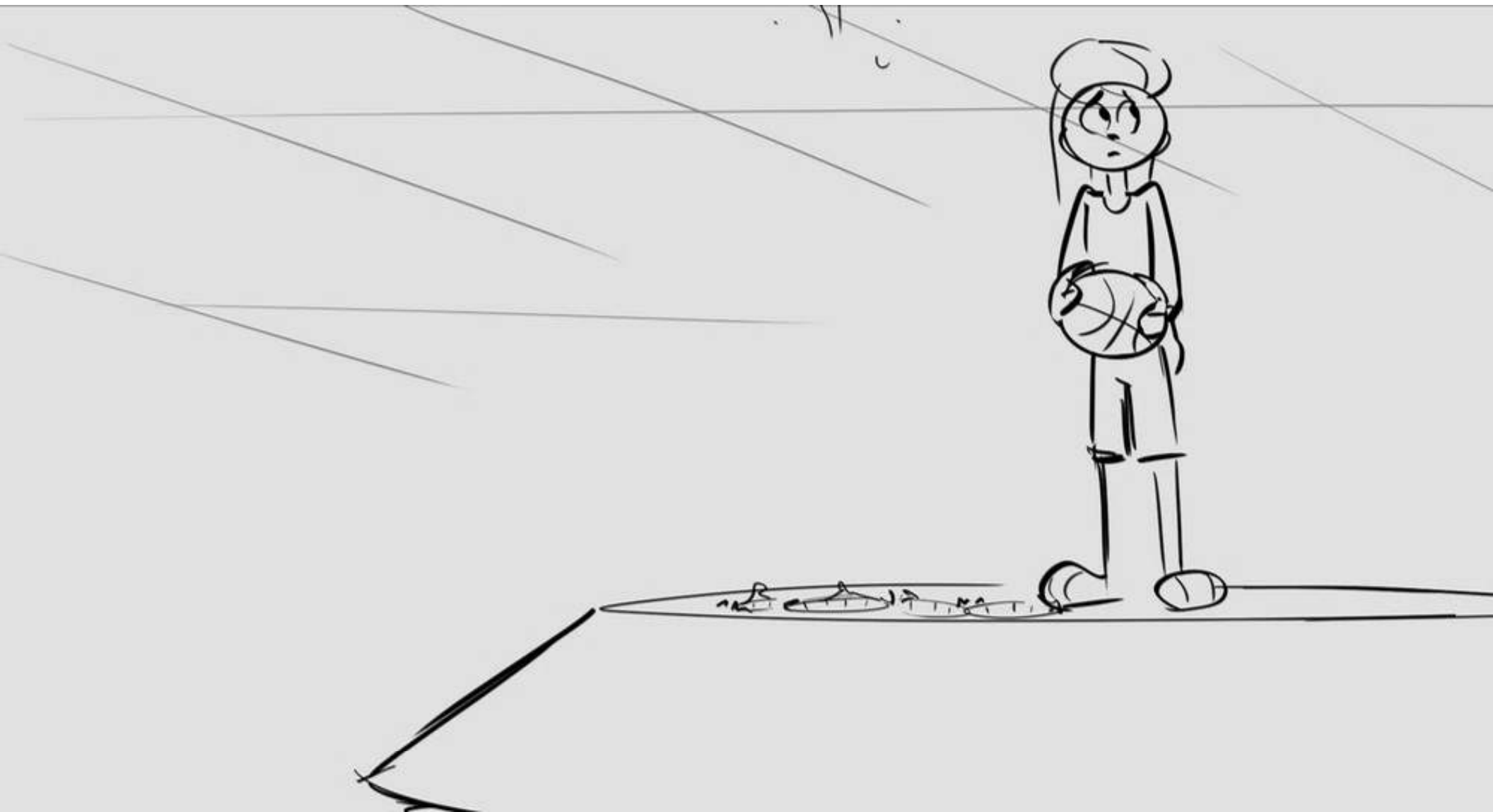

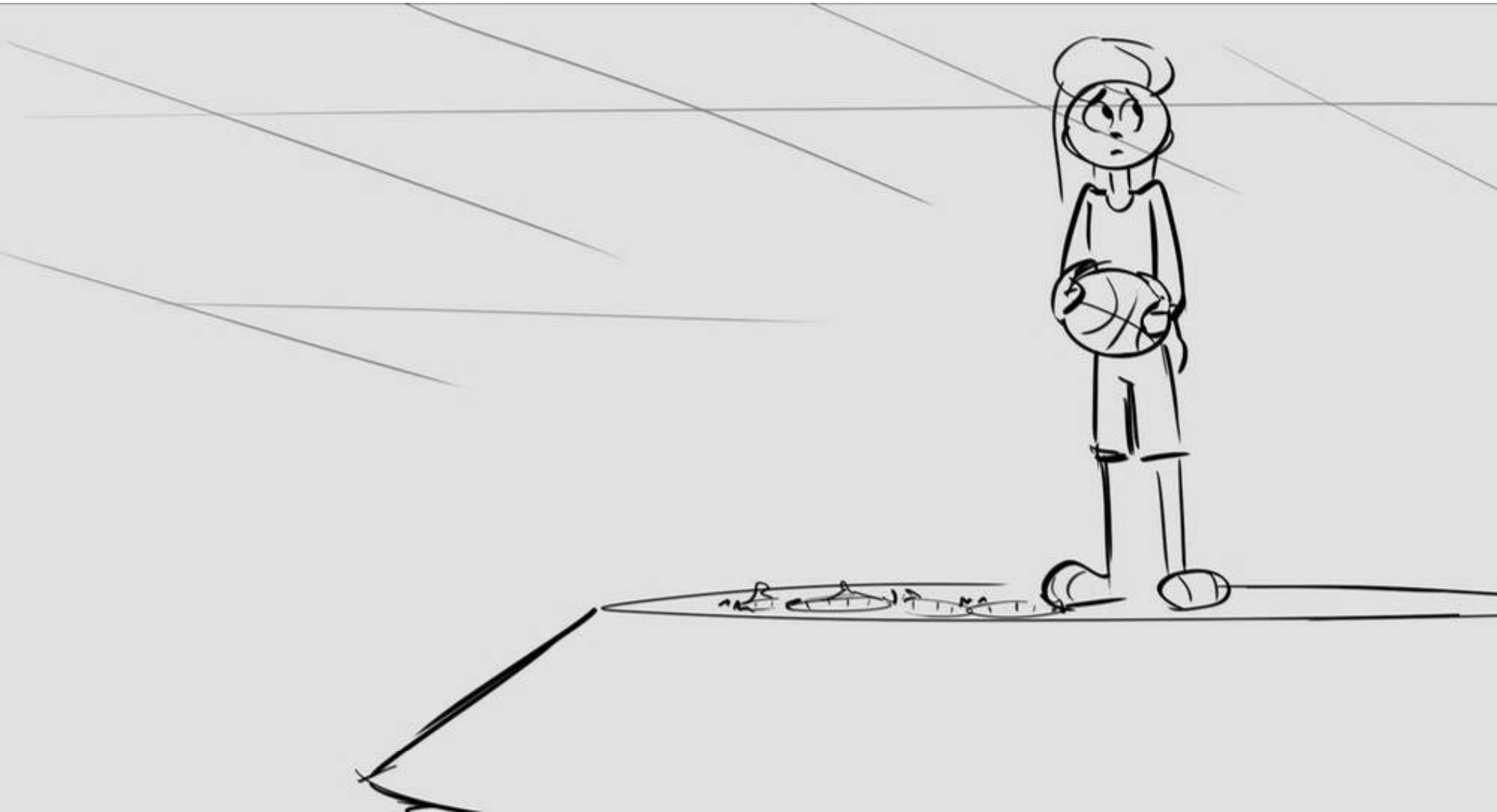

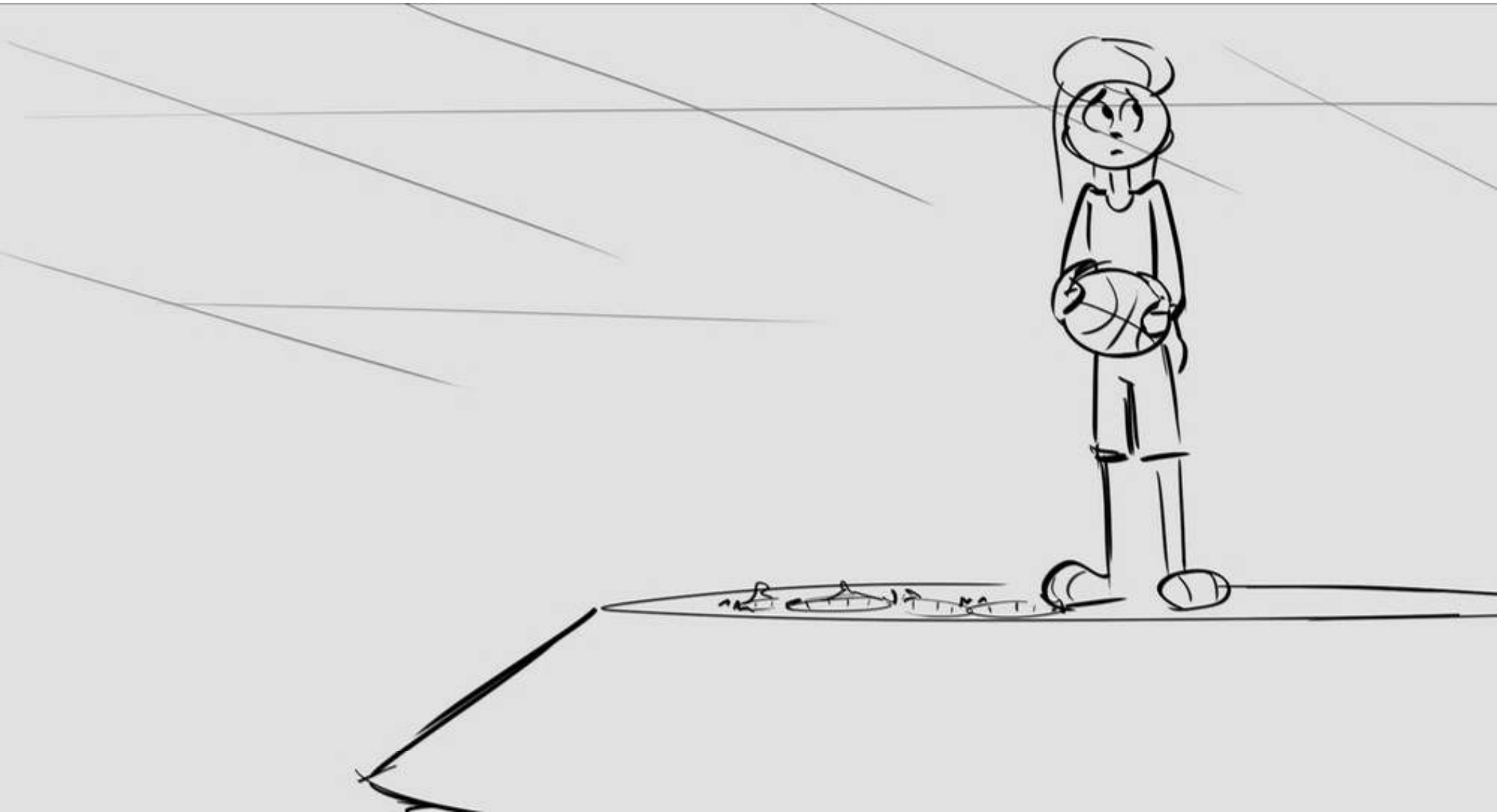

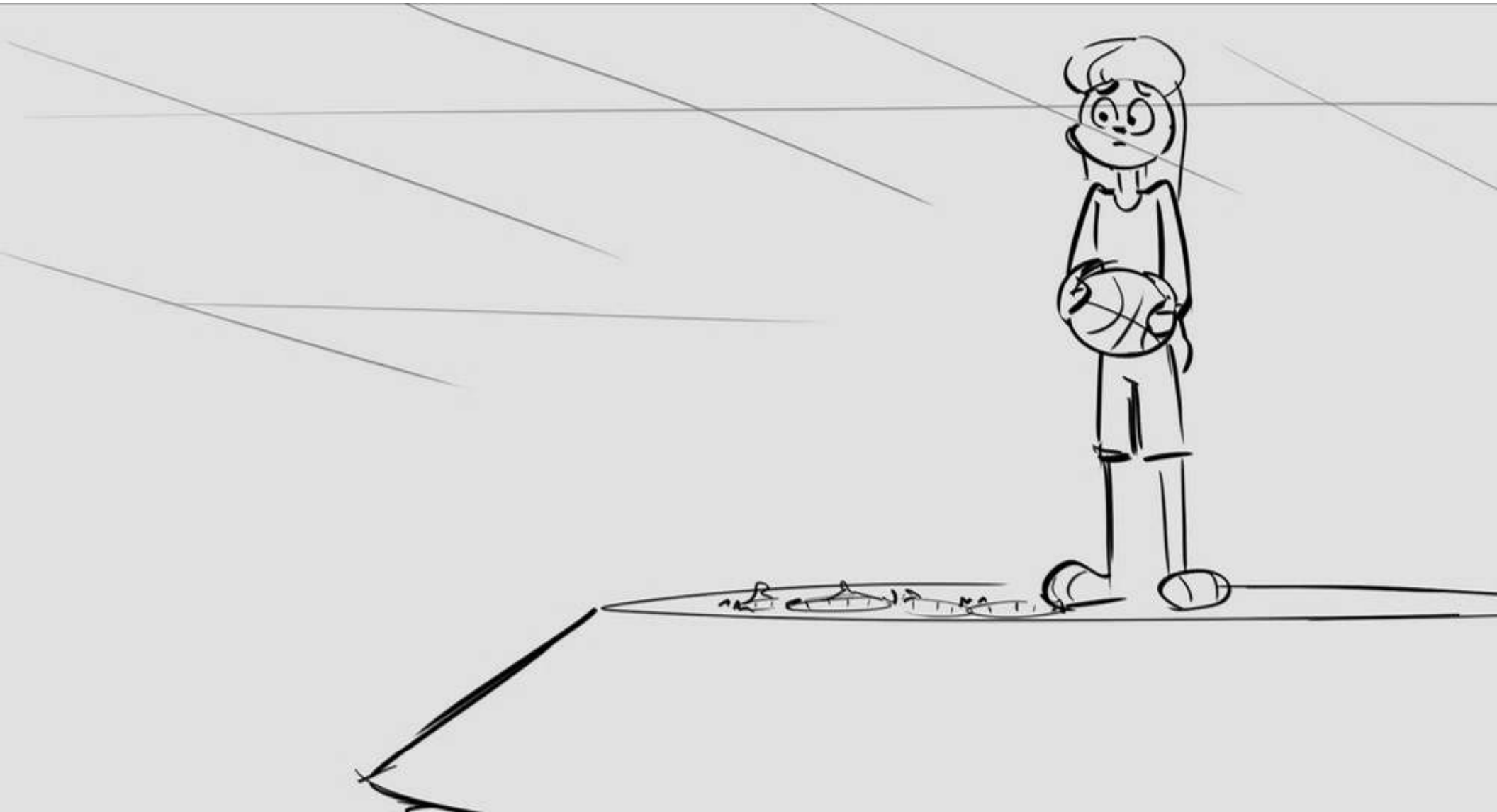





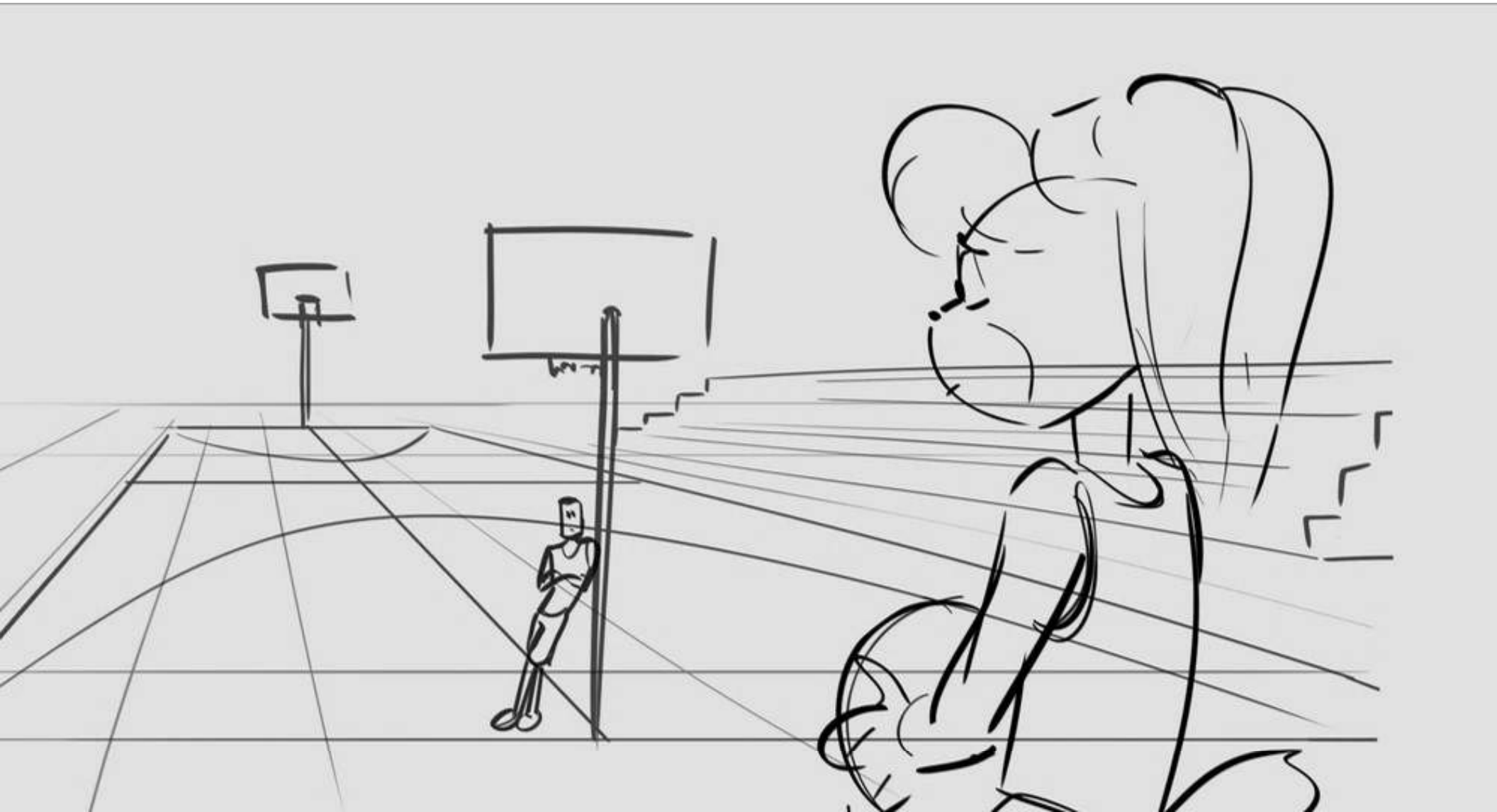

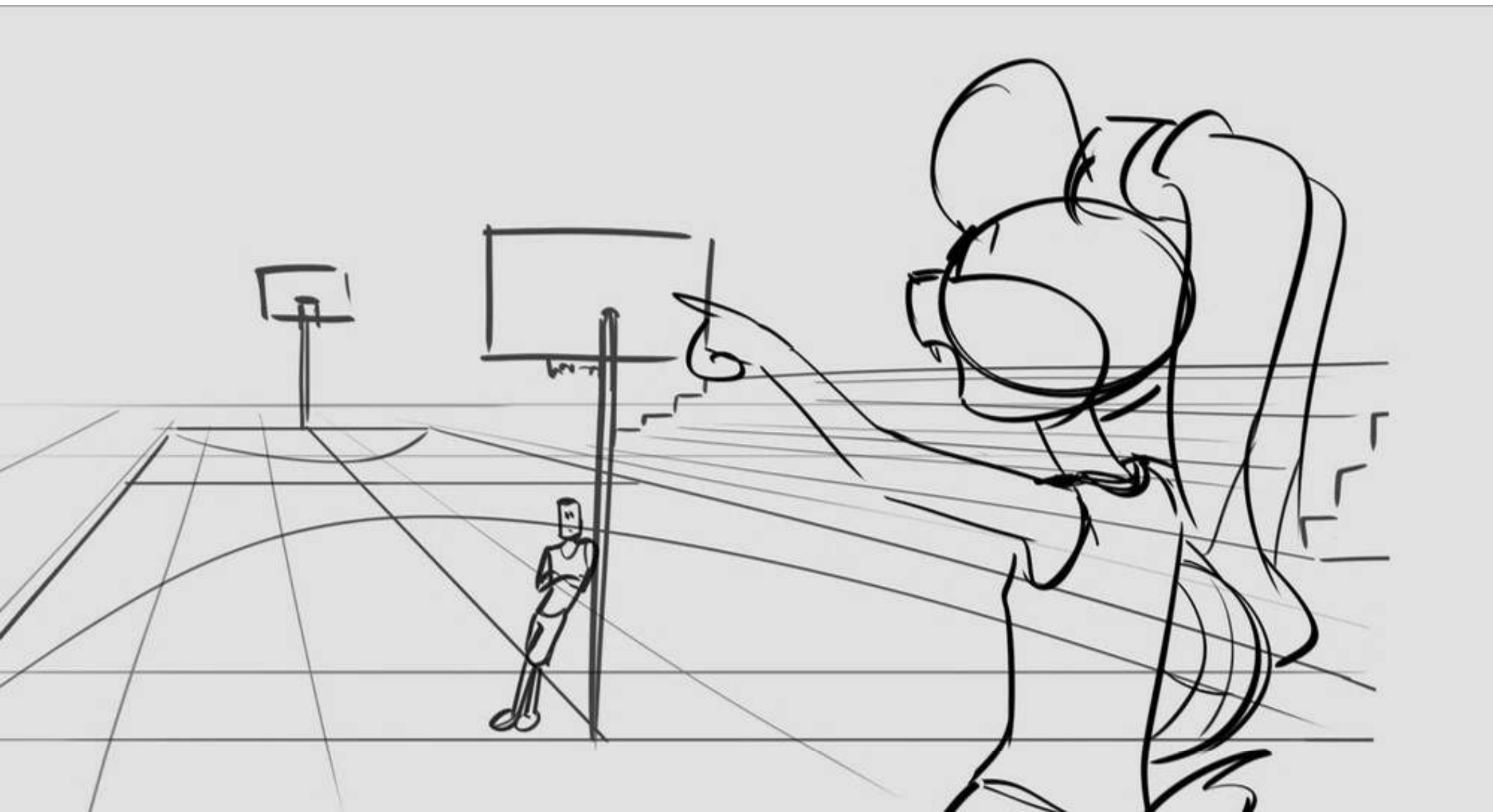

LOLA: Off the backboard

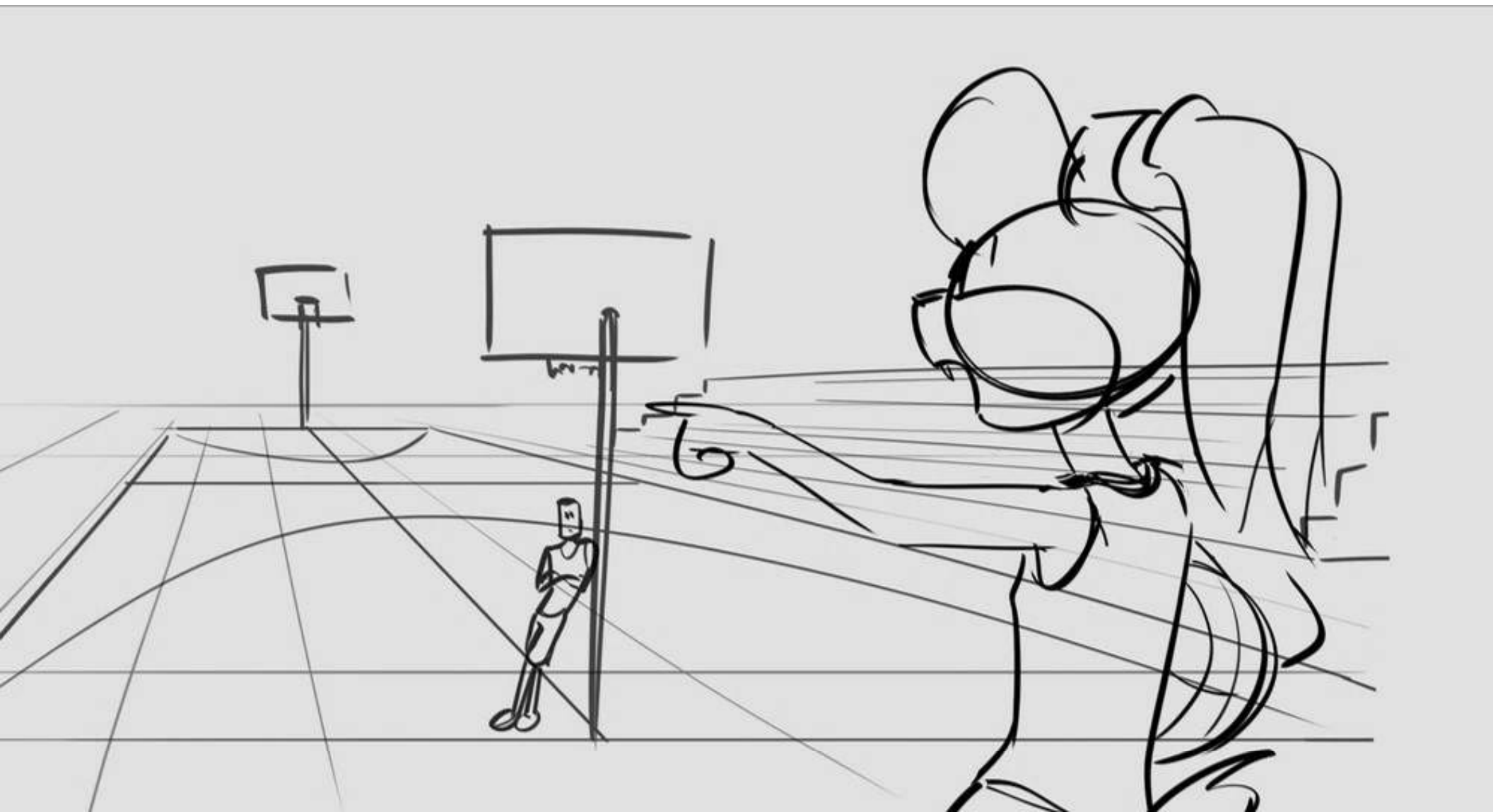

LOLA: nothing but net.

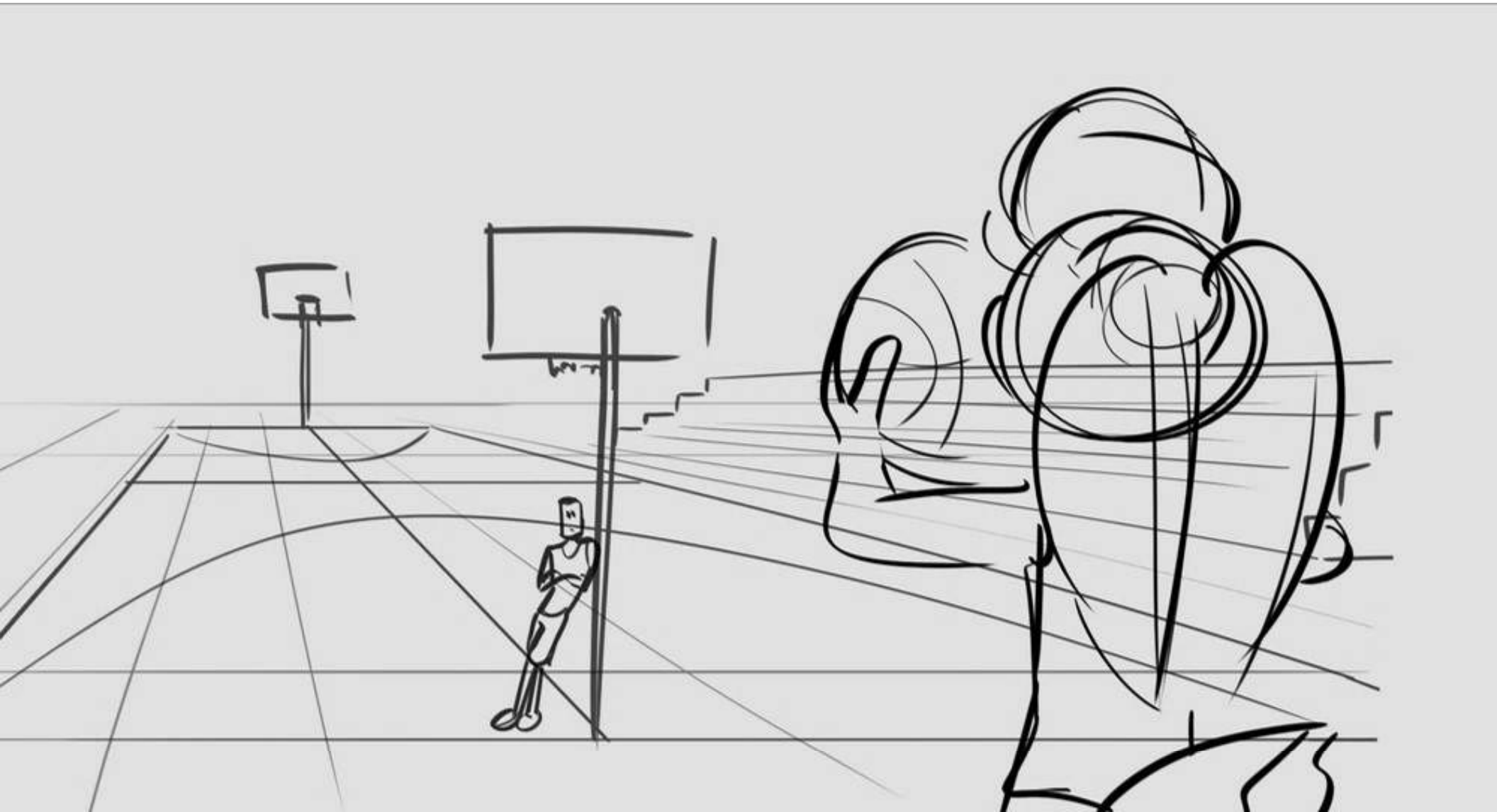

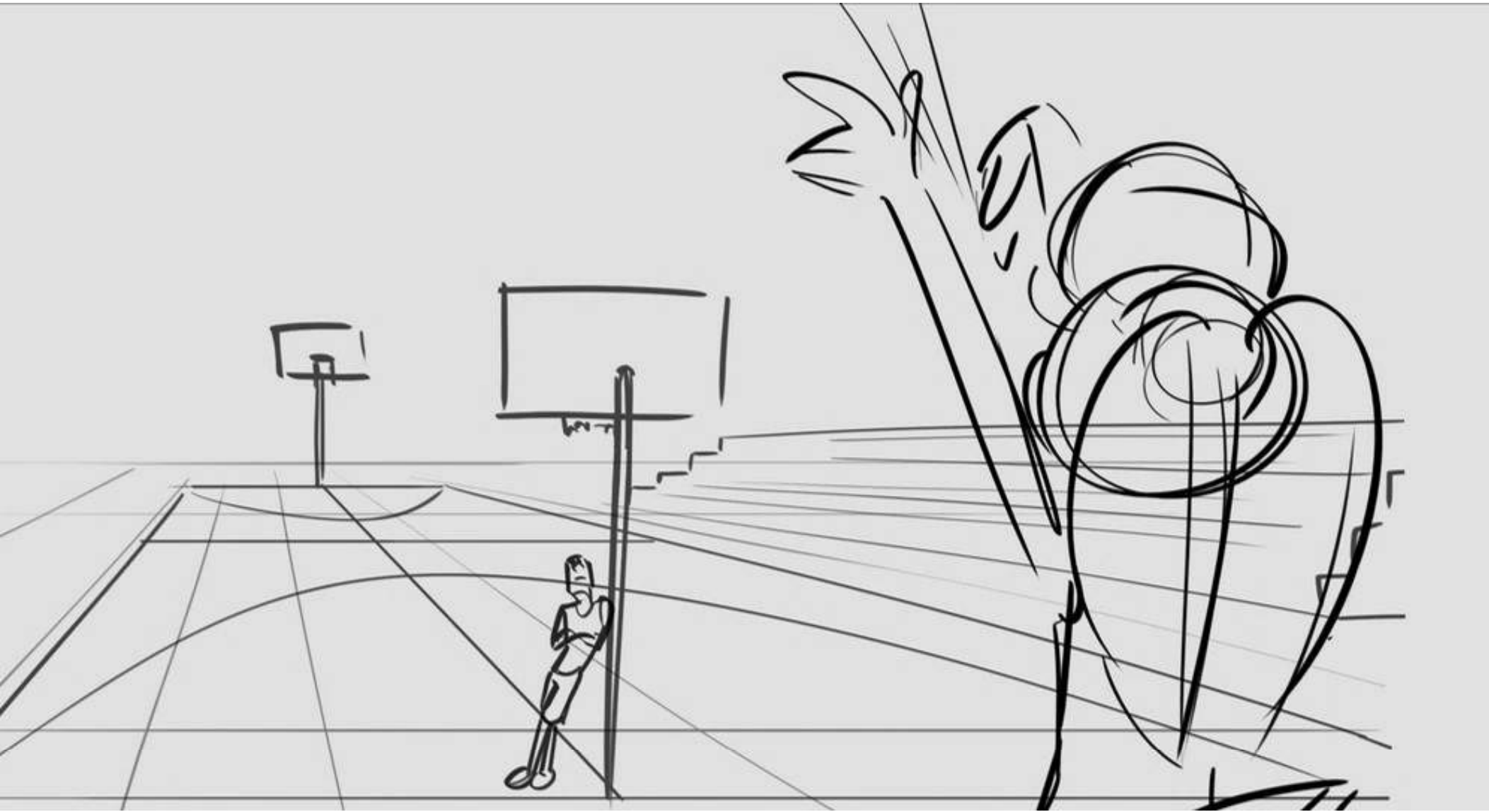

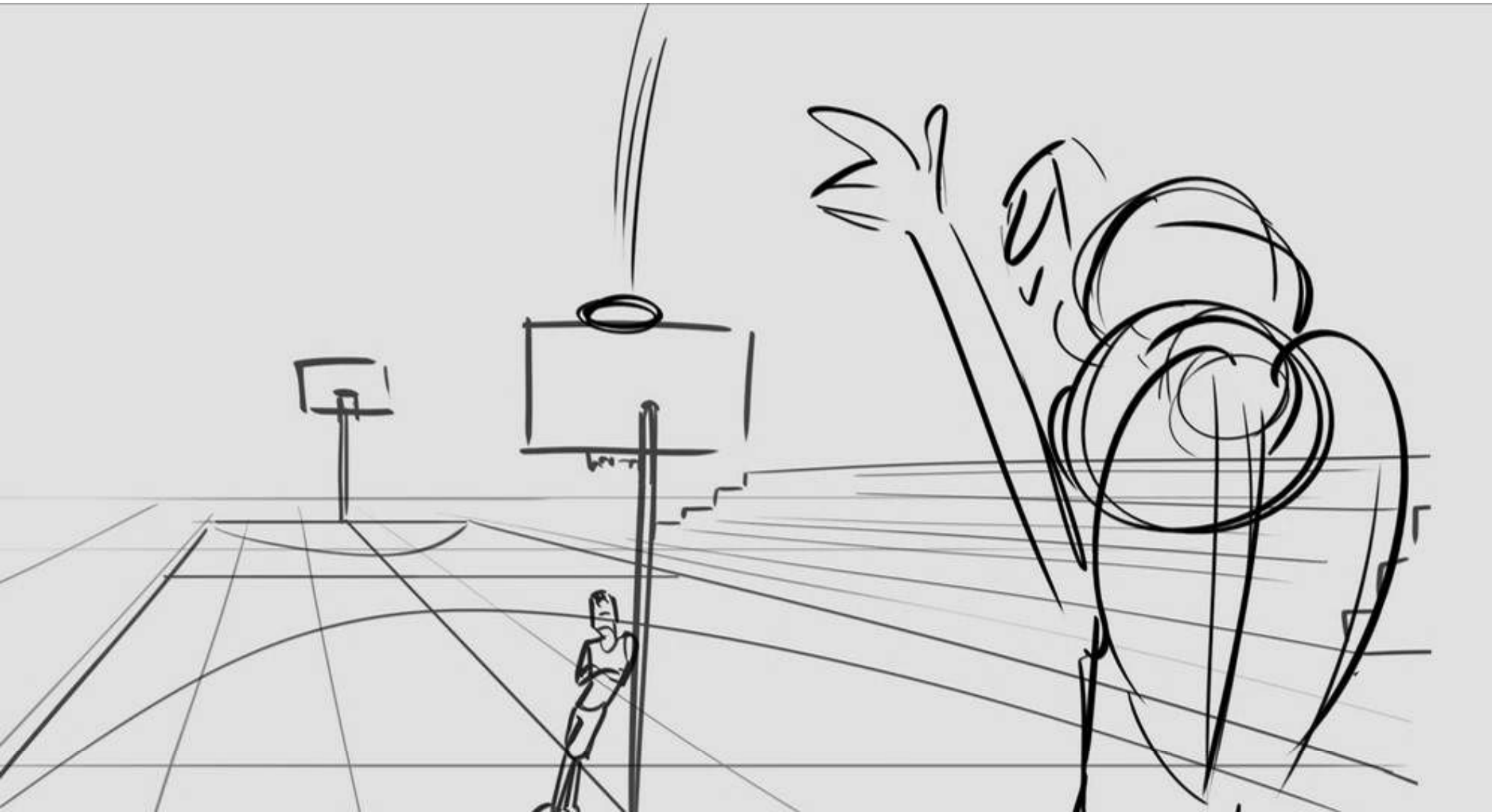



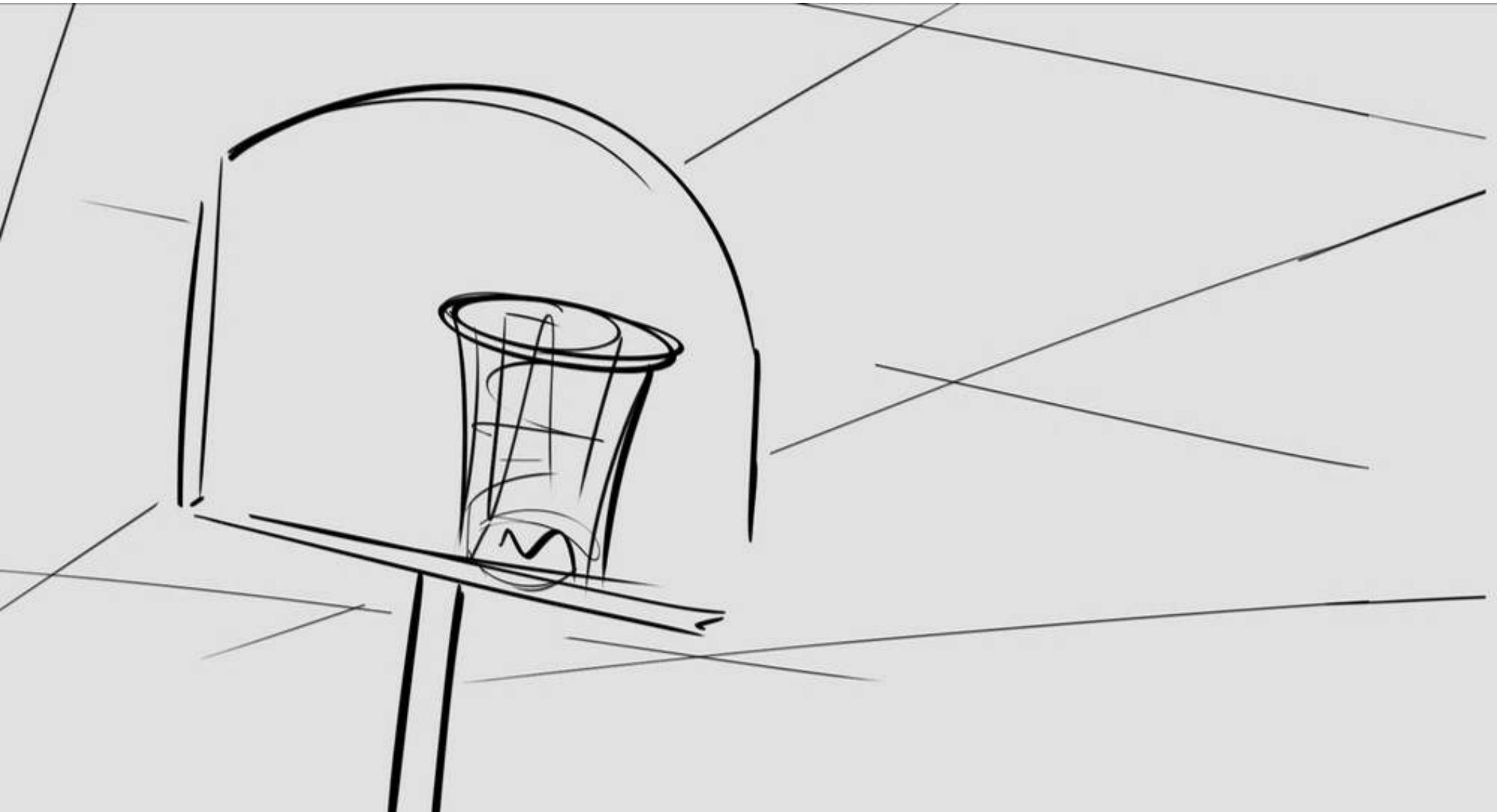

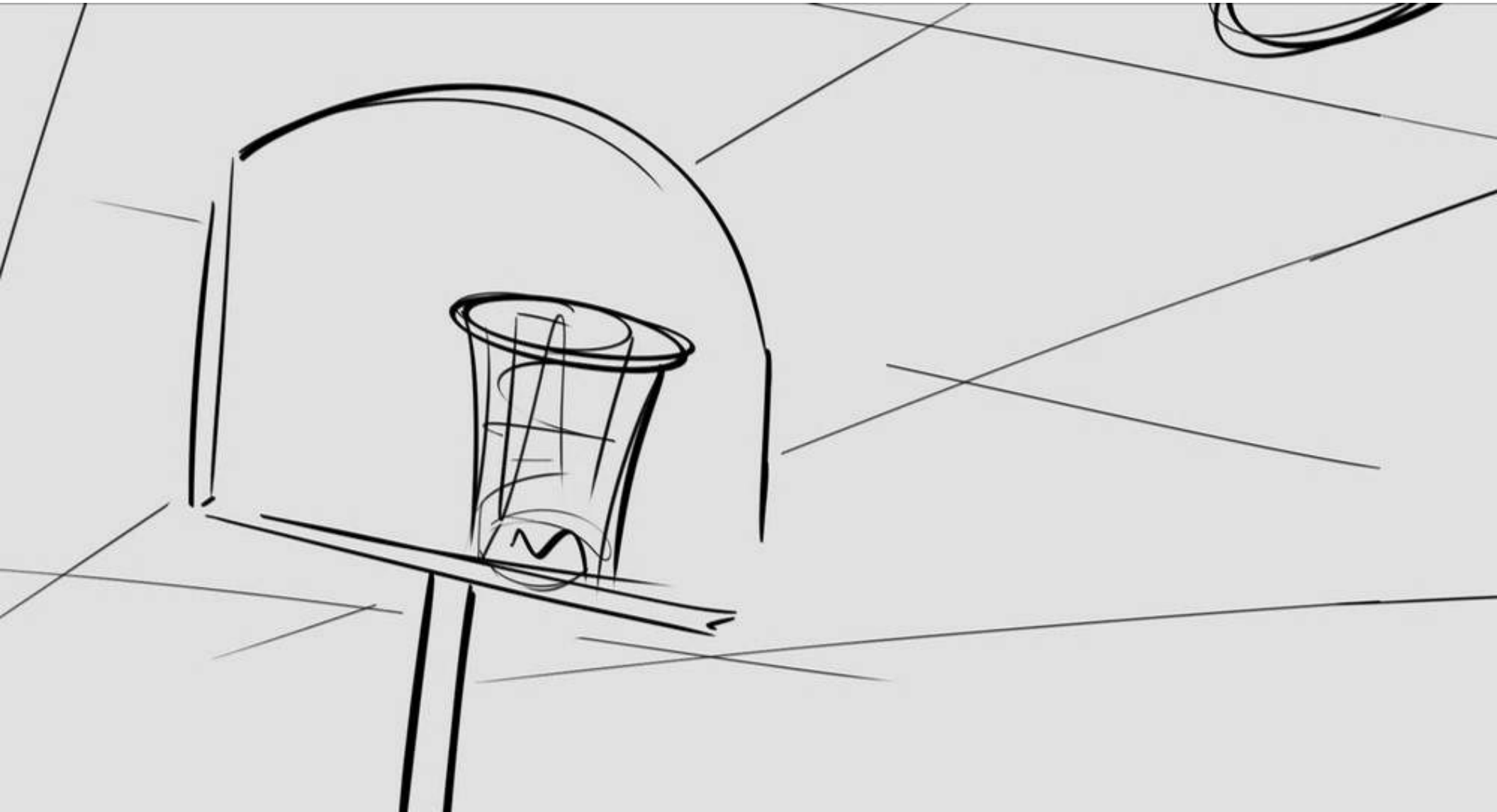

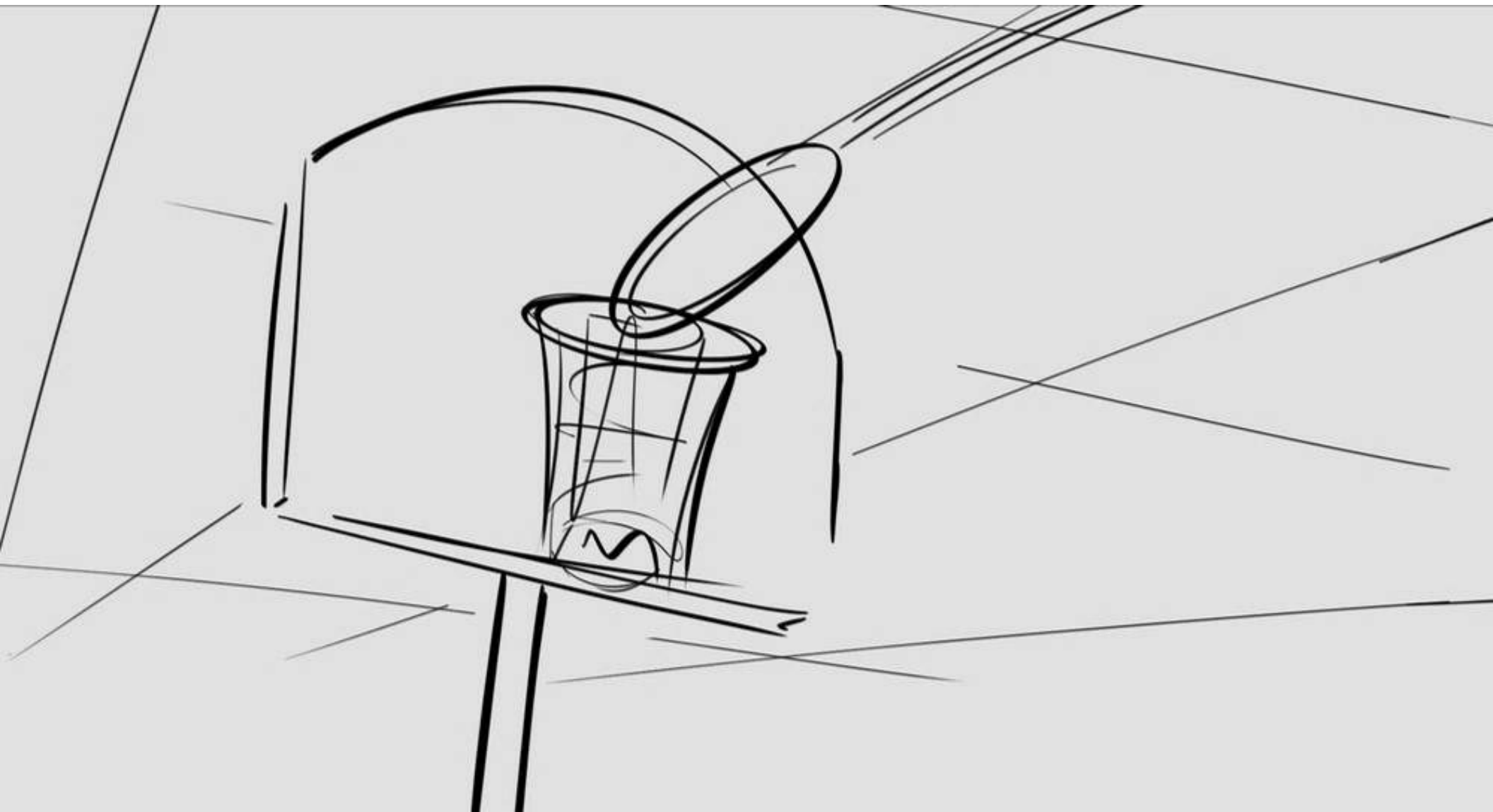

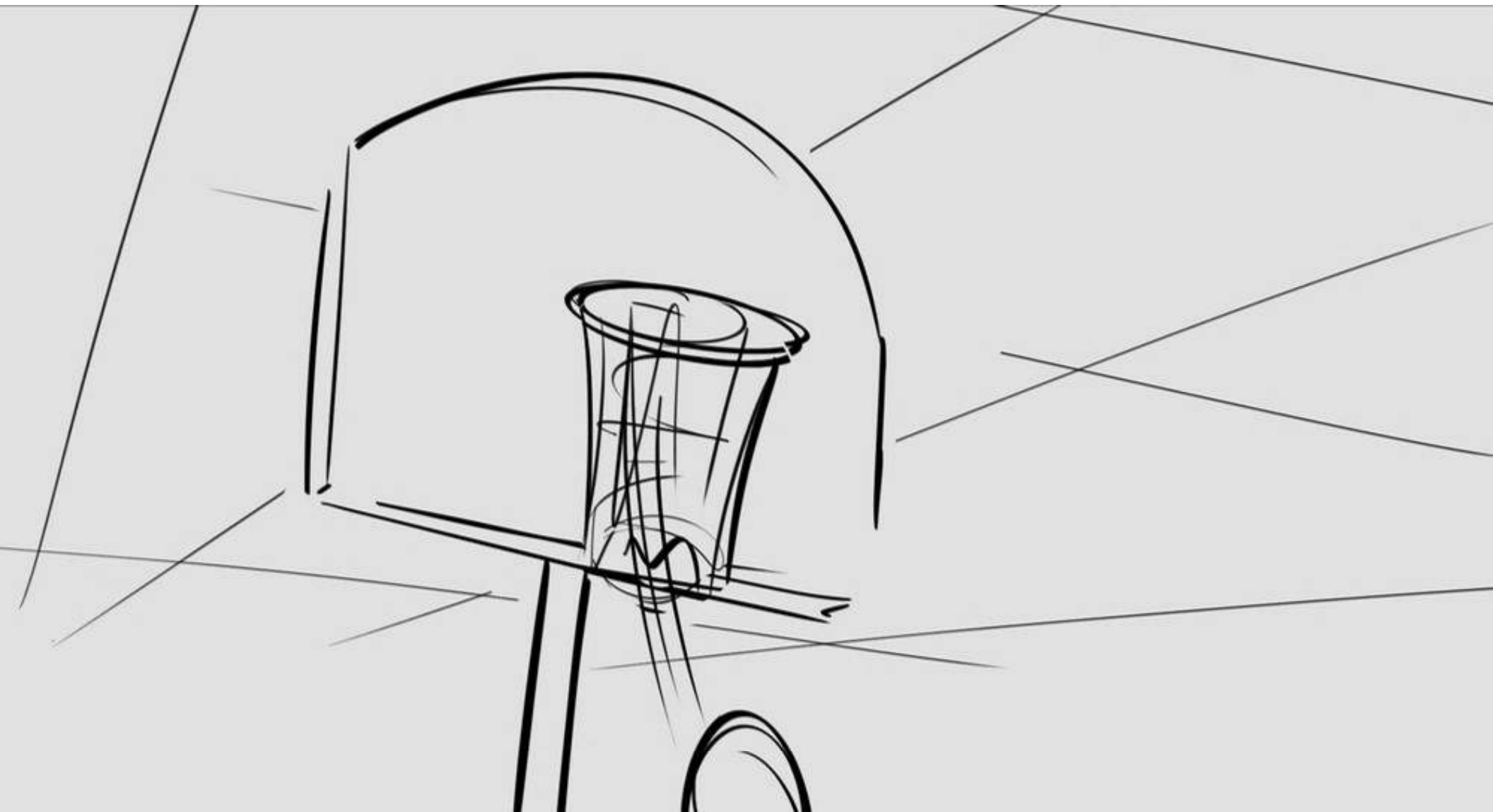

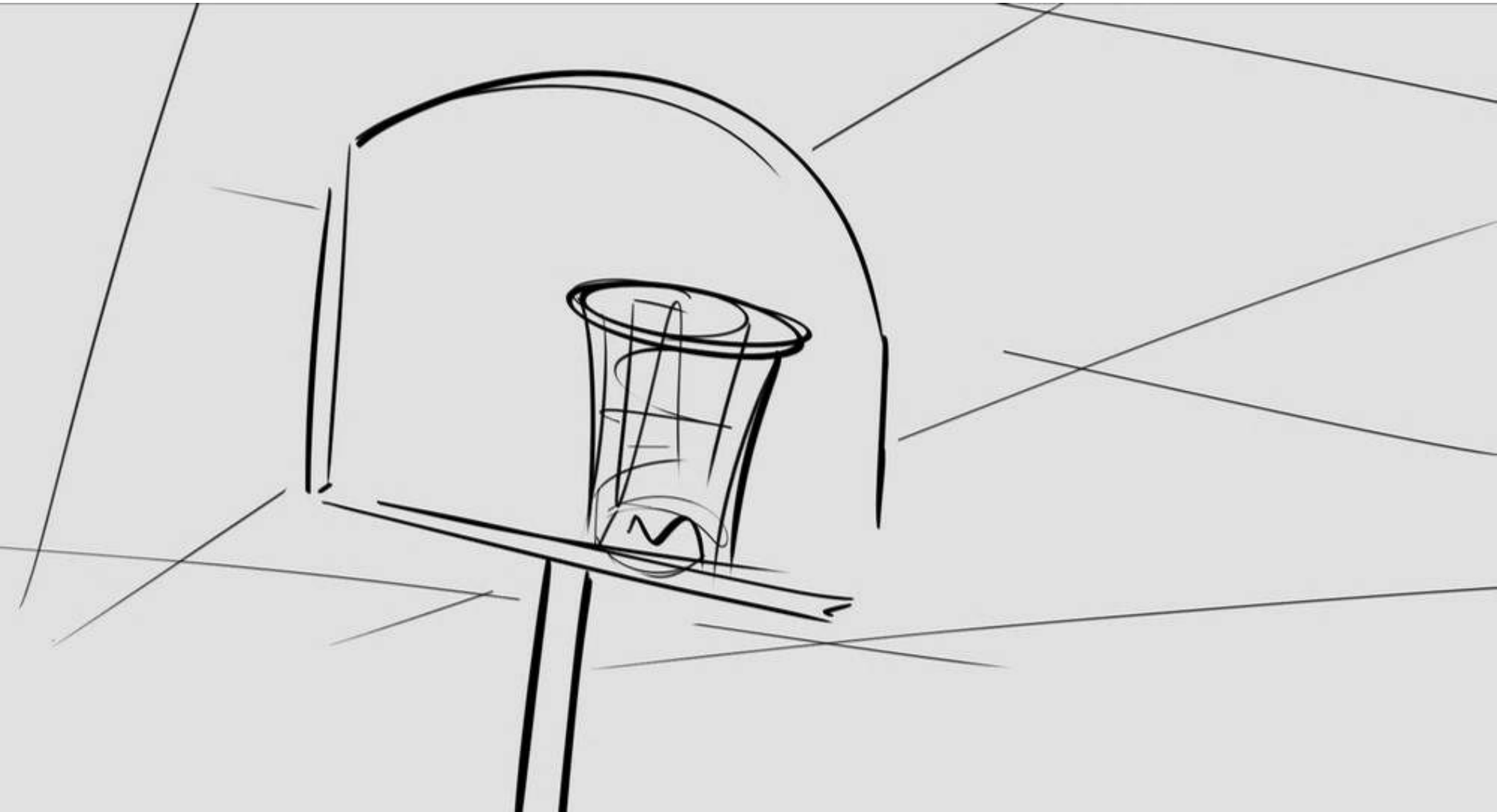

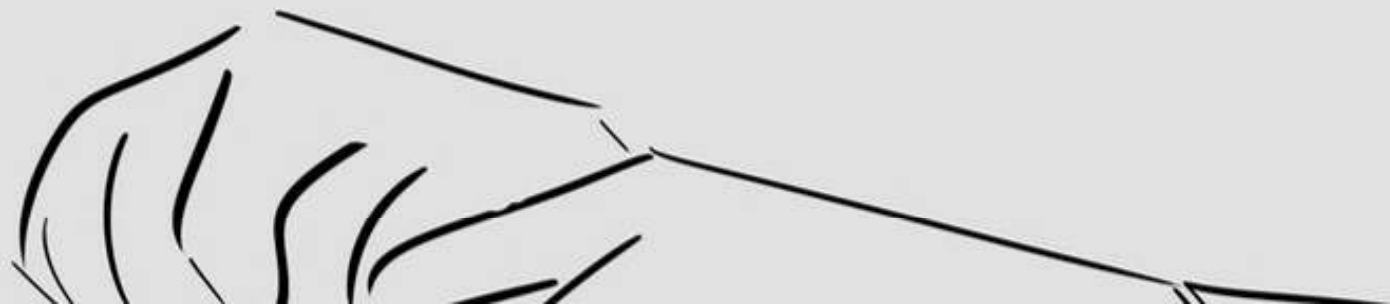

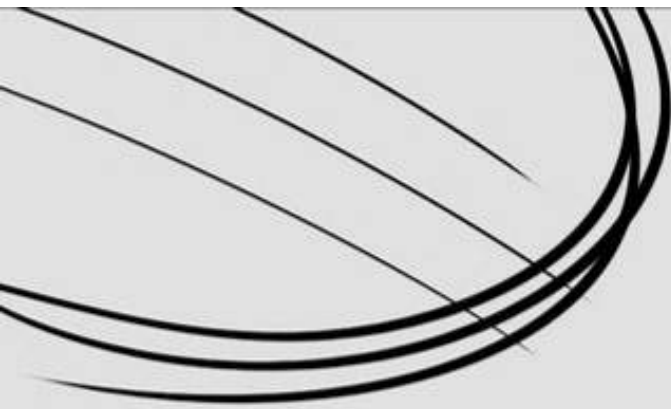









LEBRON: Well, he's gonna have to change the channel, quick.

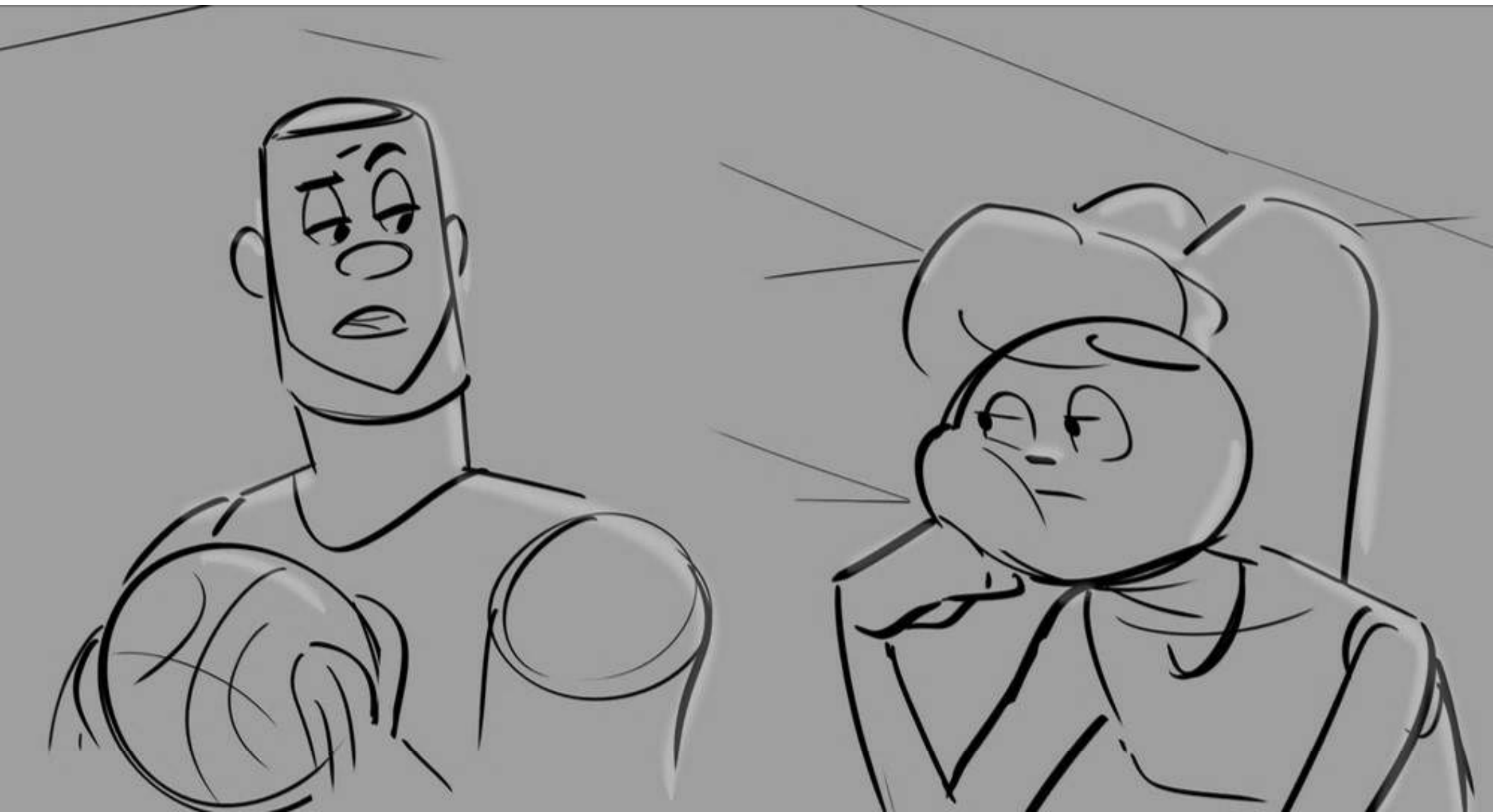

LEBRON: Well, he's gonna have to change the channel, quick.



LEBRON: Where I come from an anvil can only fall on your head once.



LEBRON: Where I come from an anvil can only fall on your head once.

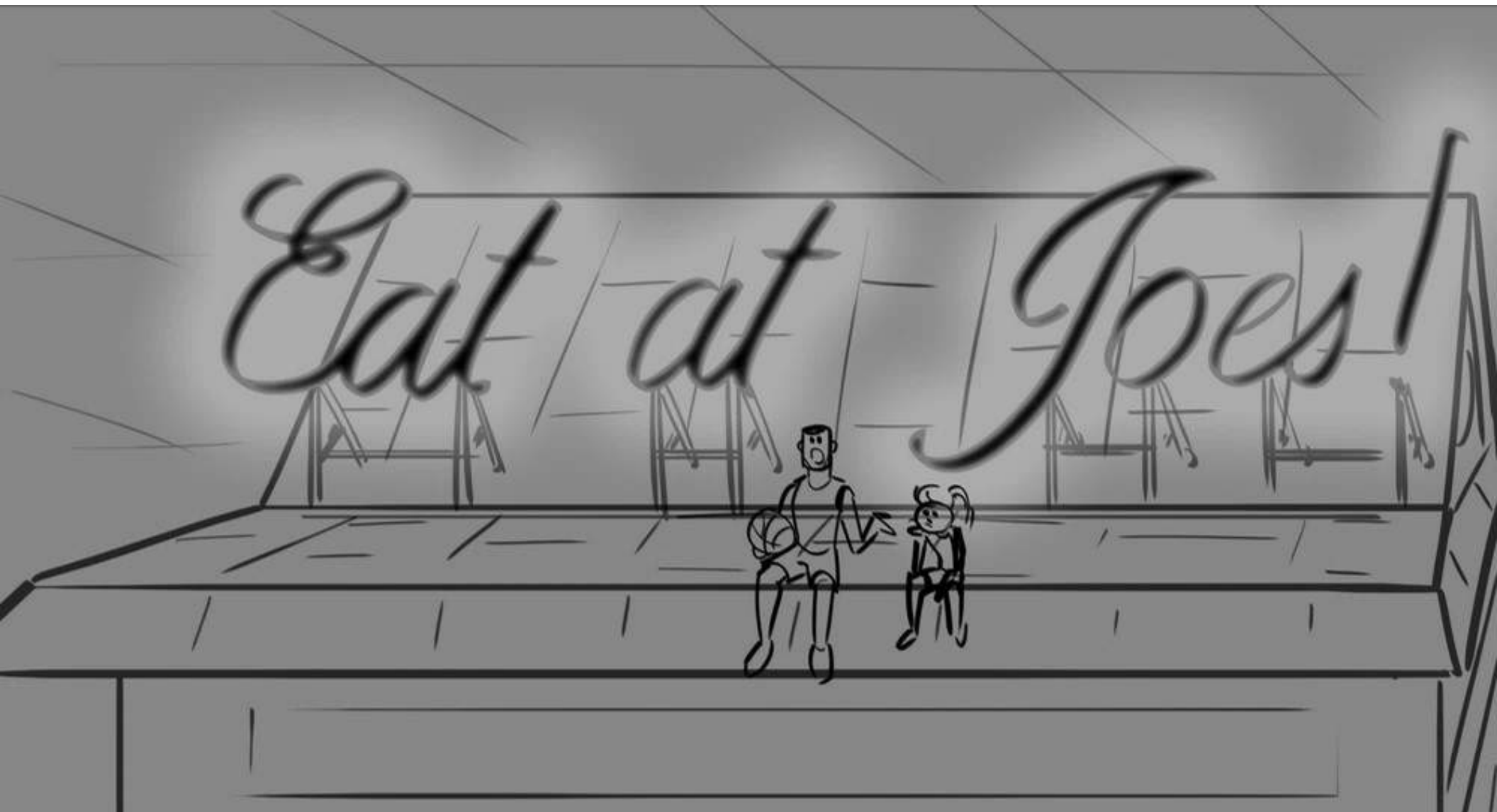

LEBRON: My son is in real danger,

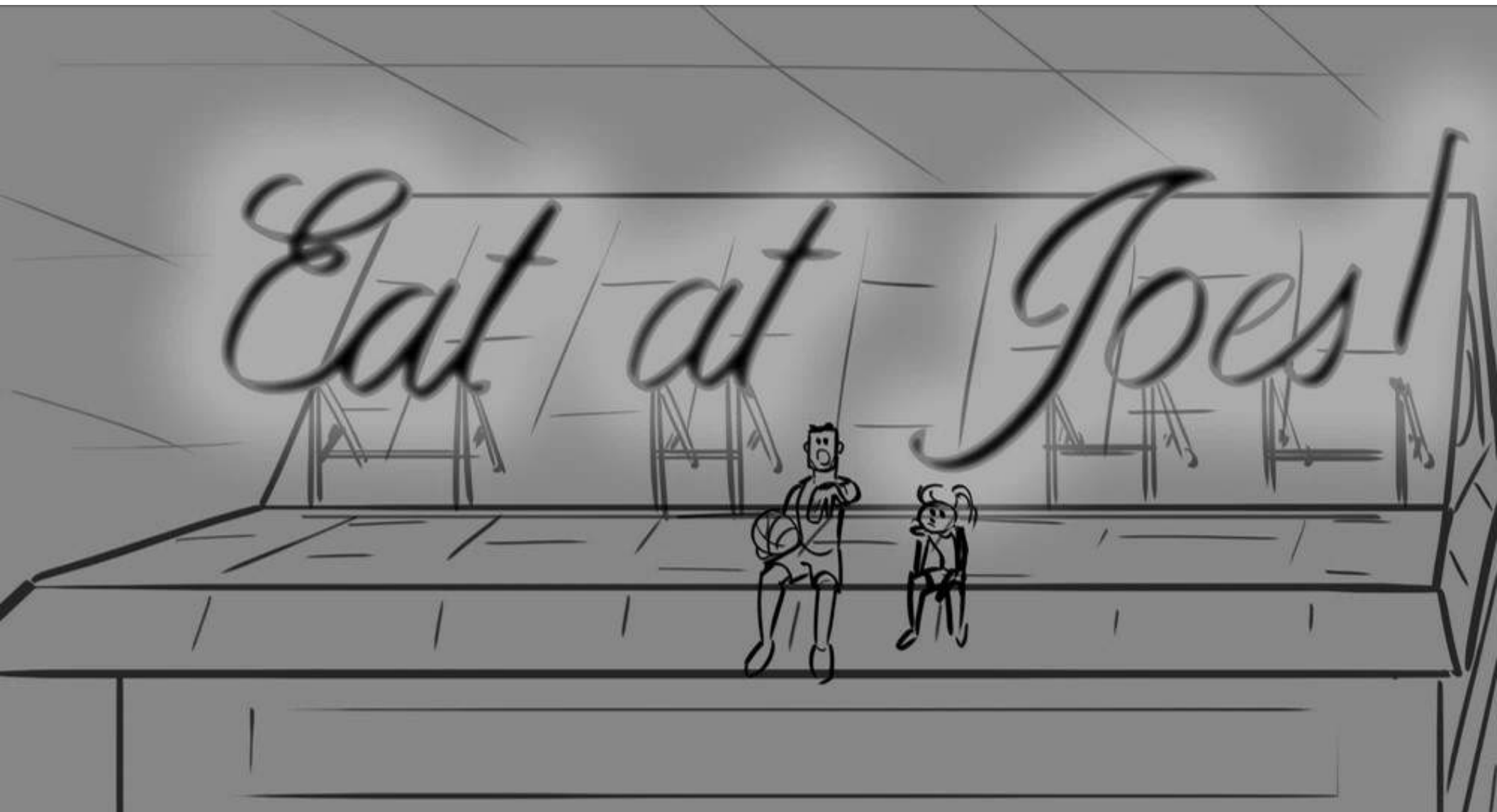

LEBRON: My son is in real danger,

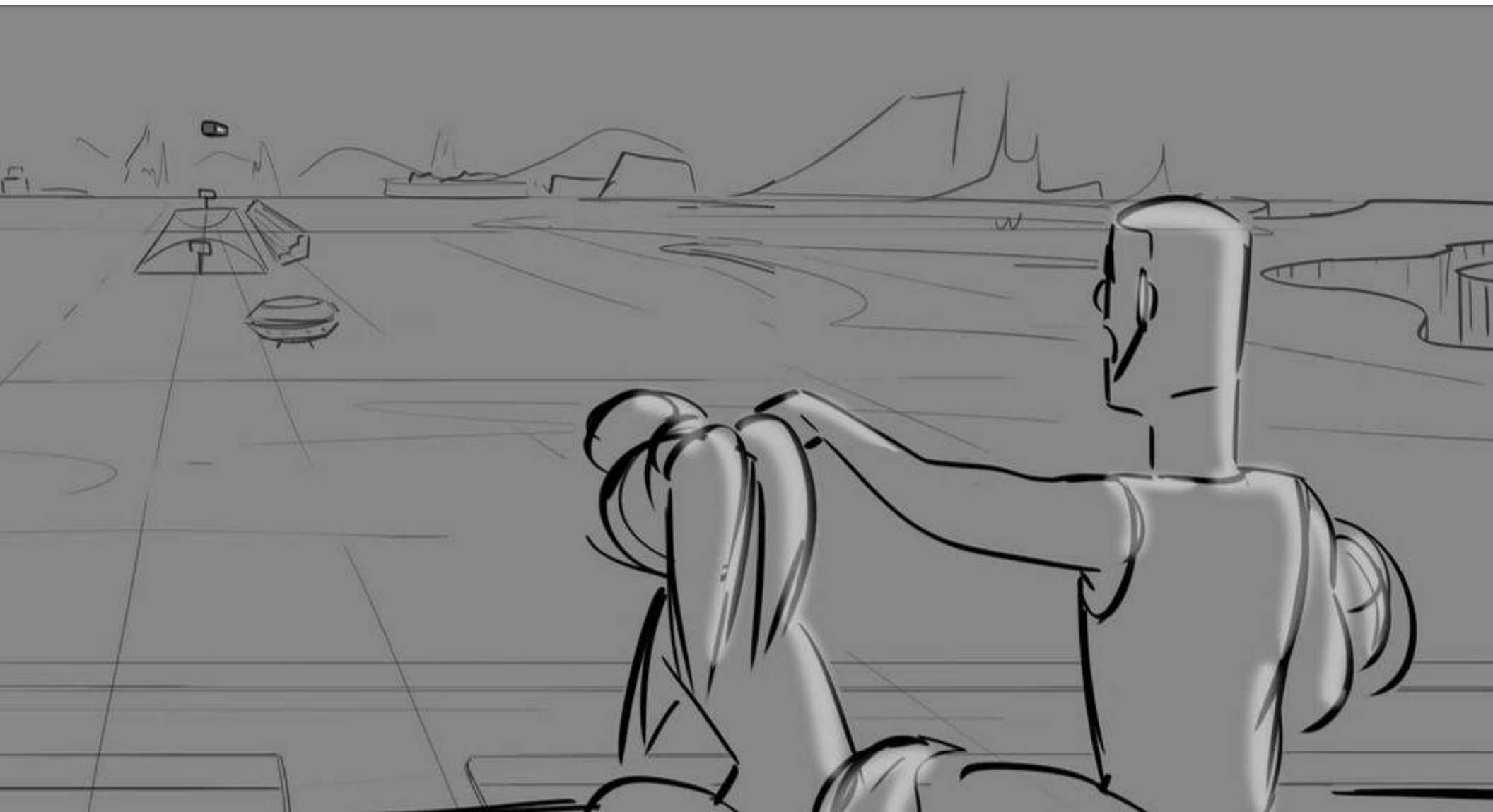

LEBRON: and from the looks of it

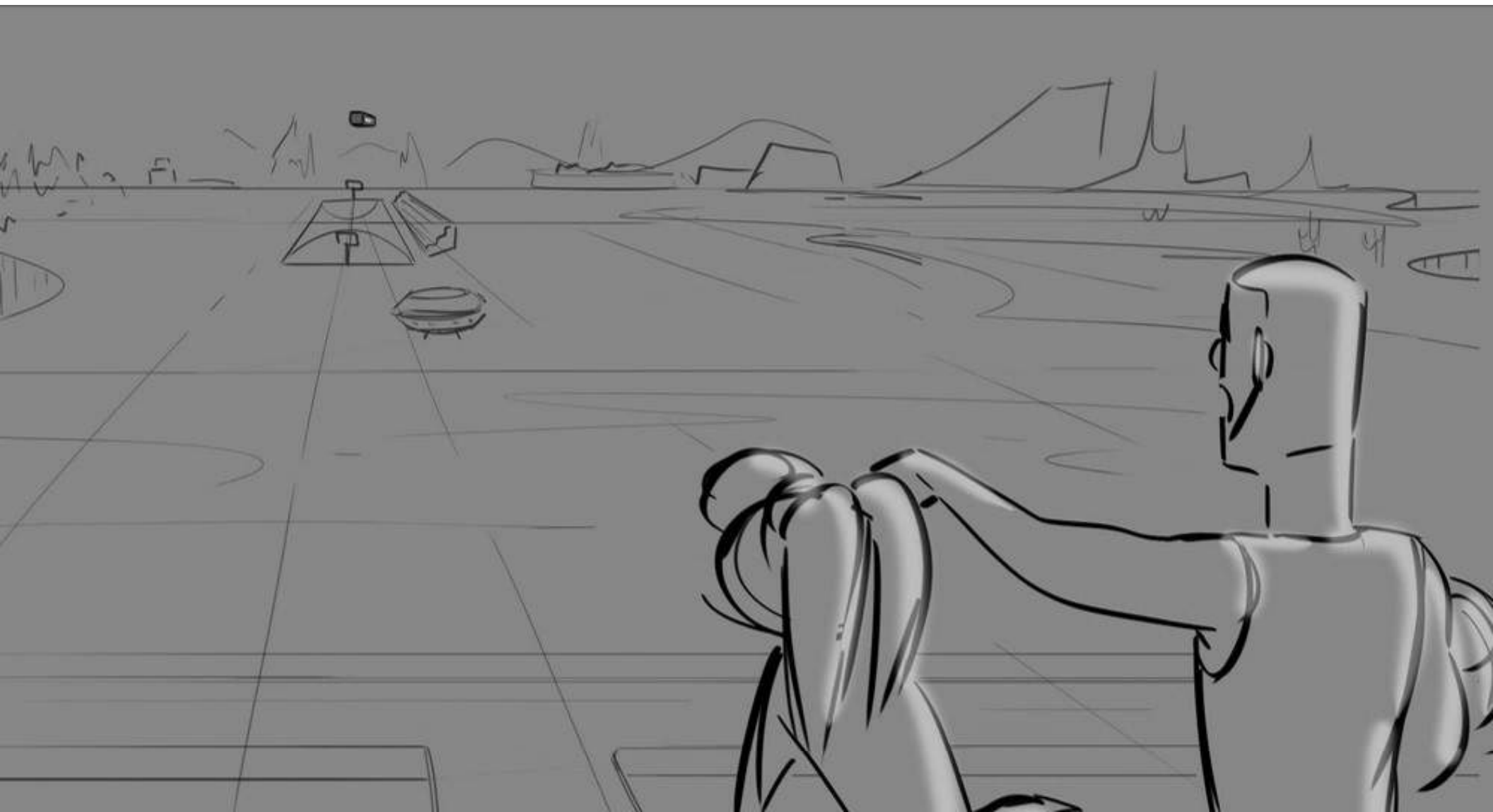

LEBRON: and from the looks of it

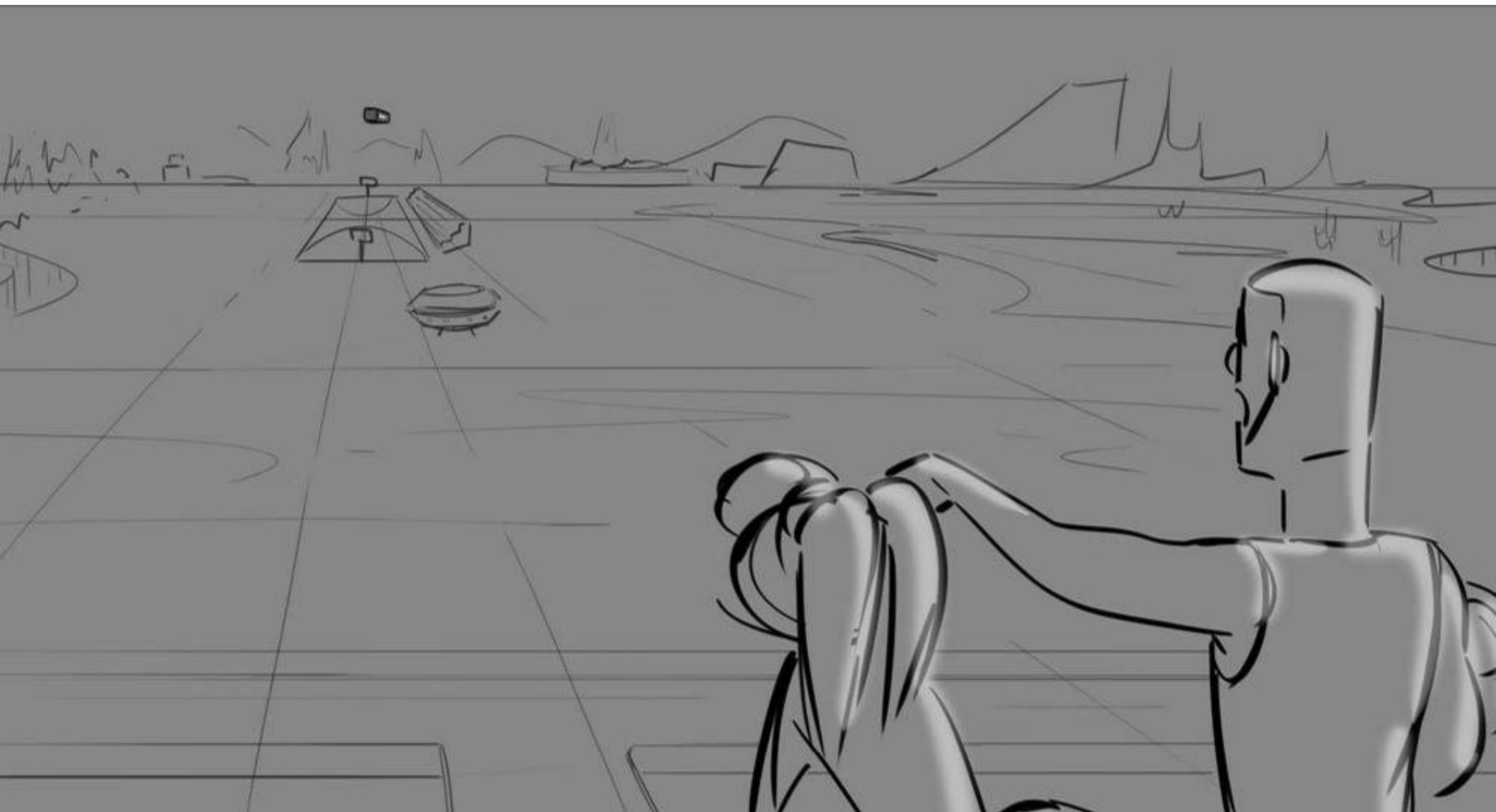

LEBRON: and from the looks of it



LEBRON (OS): So is Tune World.



LEBRON (OS): So is Tune World.



LEBRON (OS): So is Tune World.



03:42:09

Time until AI G- brings The Sanckdown



LEBRON: You're showing up for me, but the rest of the Tunes?

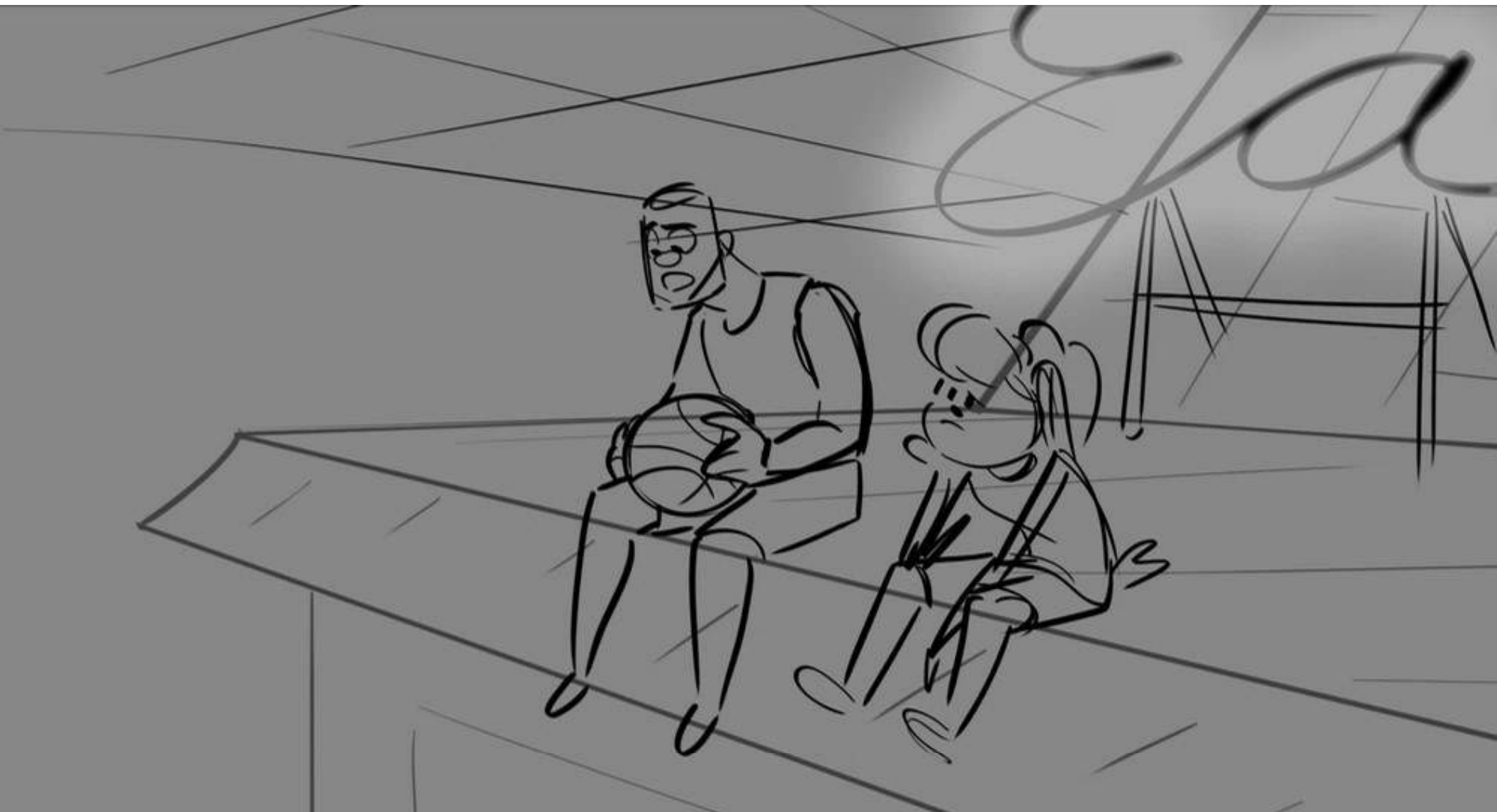

LEBRON: You could build a bridge outta those bricks.



LOLA: The rest of them can be convinced.

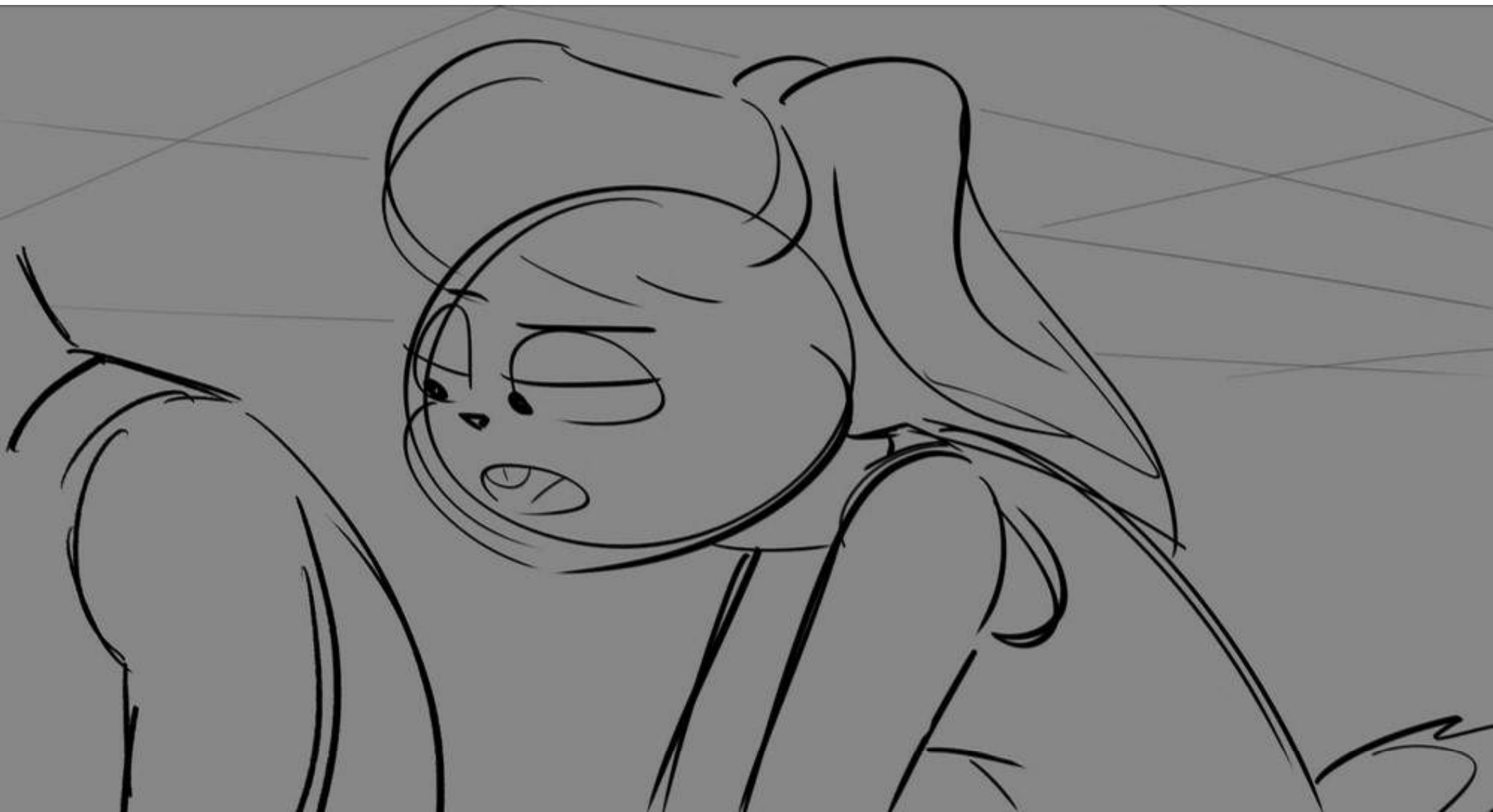

LOLA: I think.



LOLA: But Bugs...



LEBRON: Be buggin'?

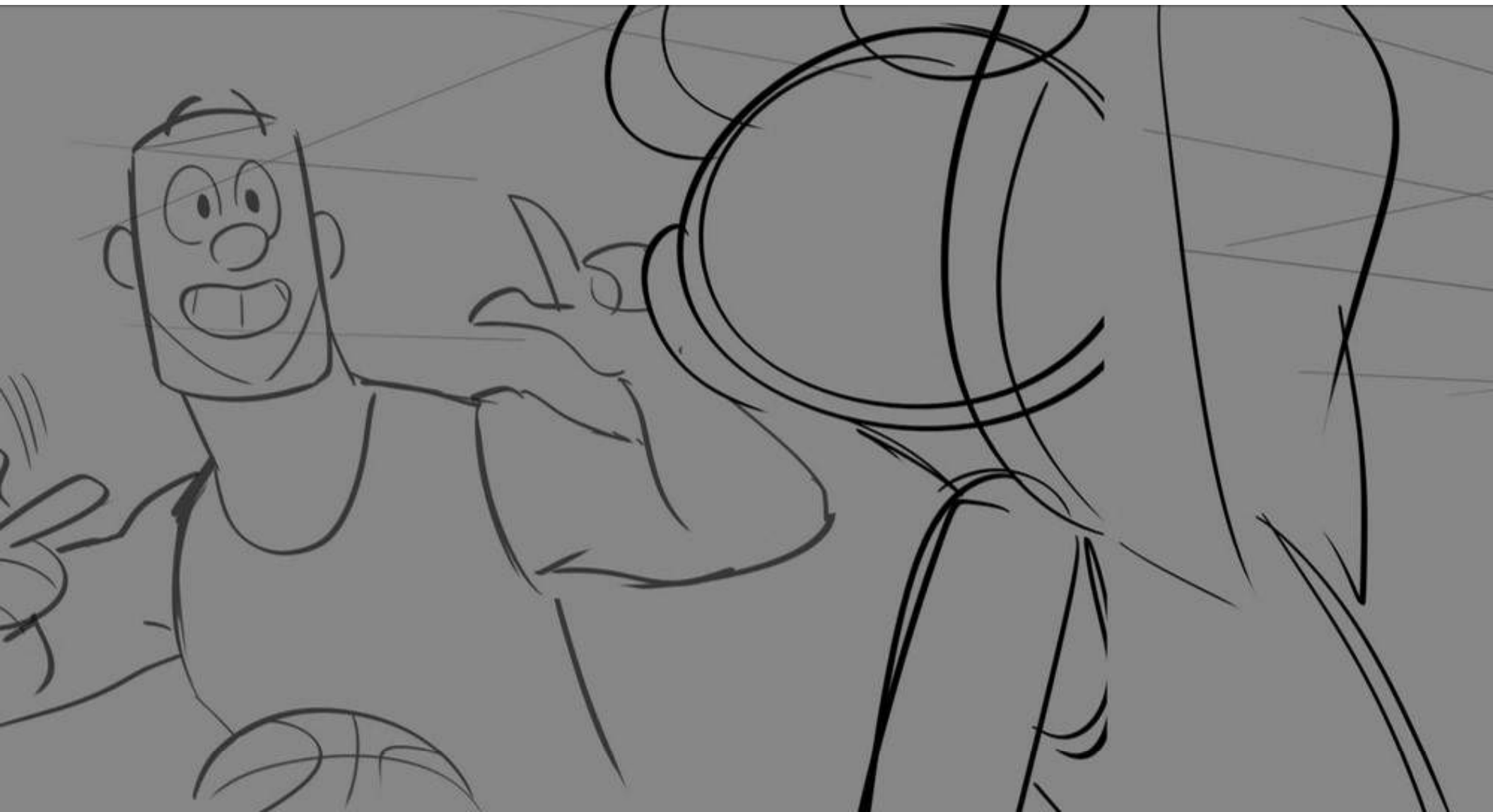

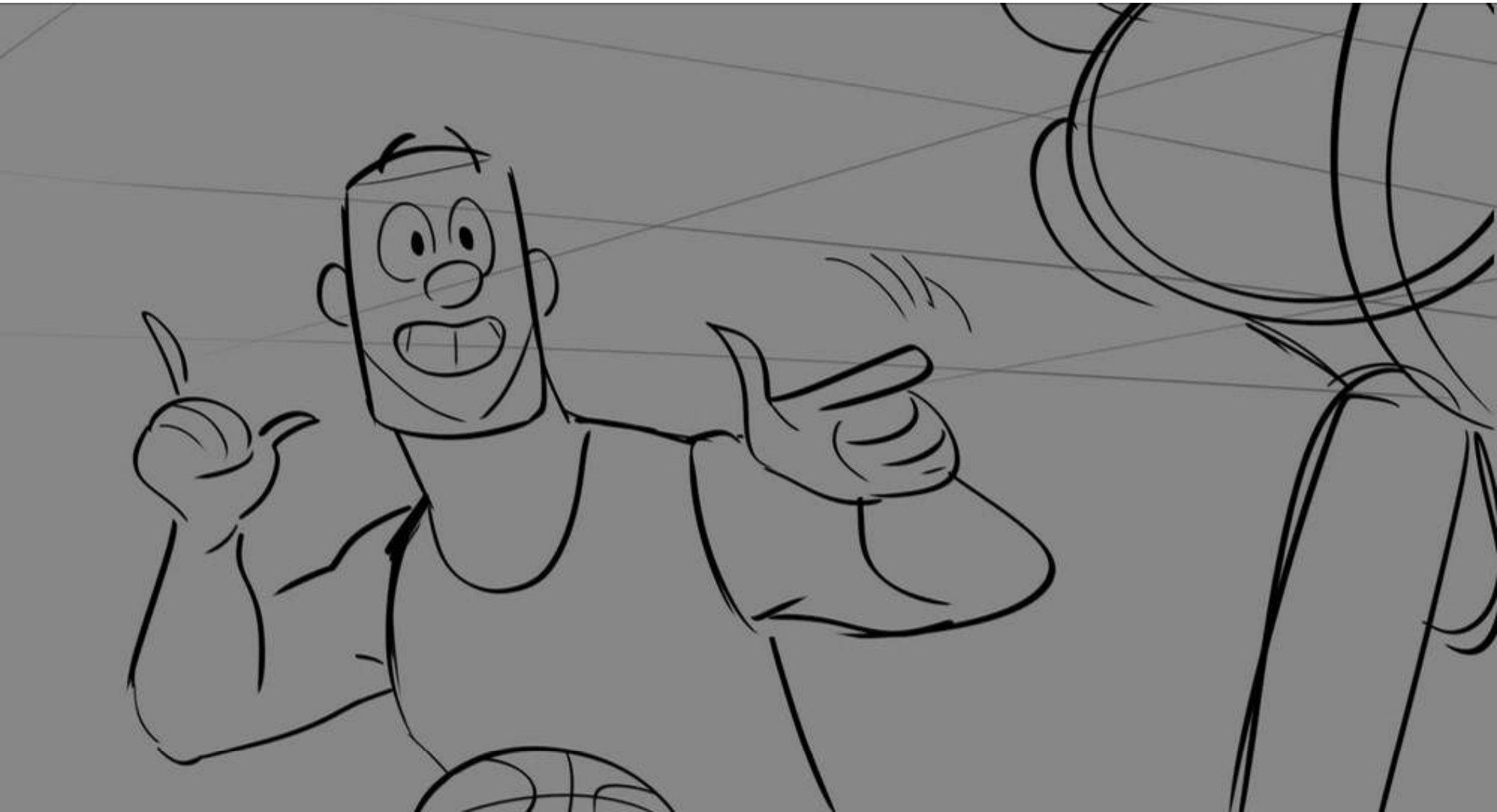

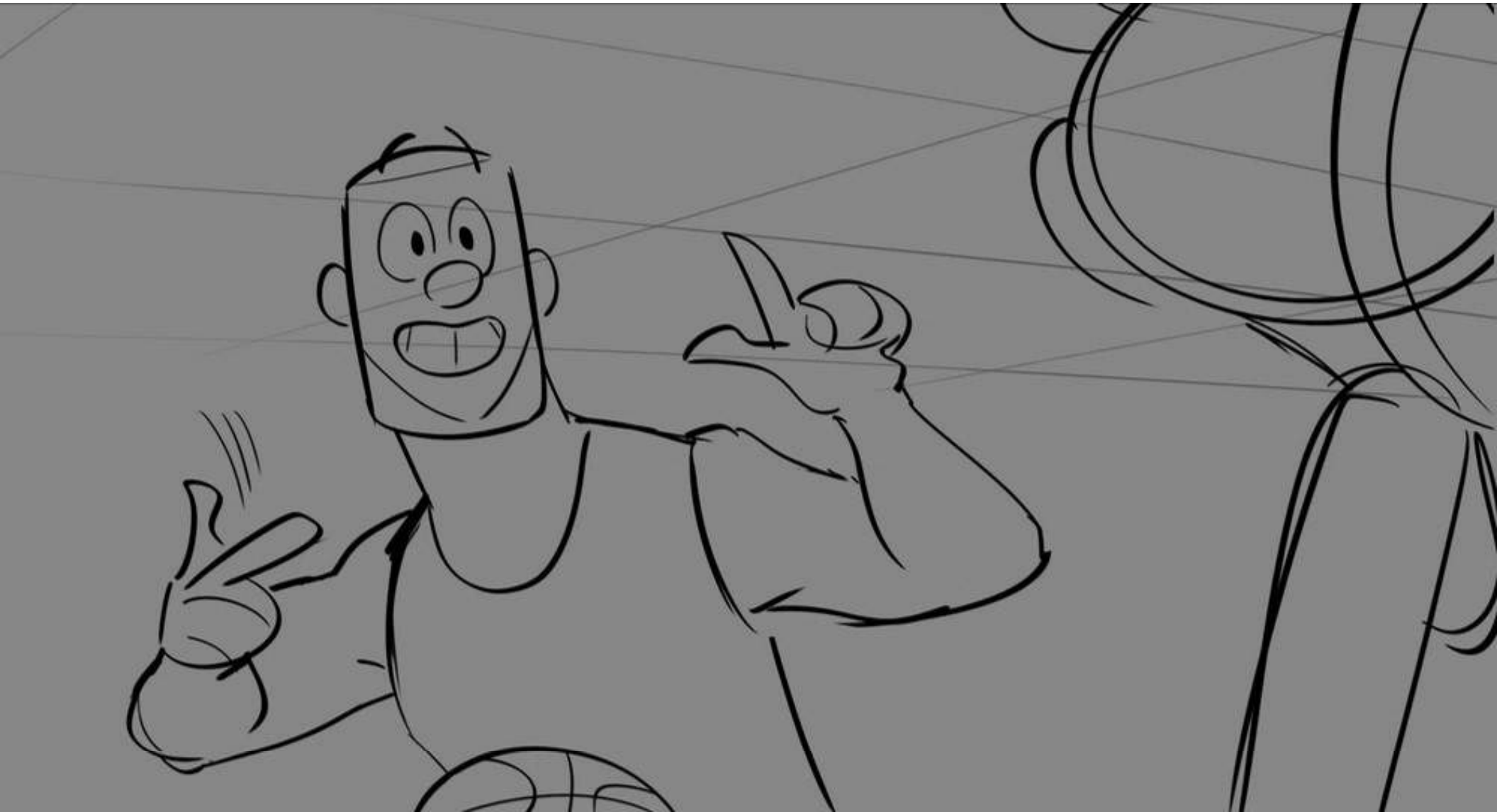

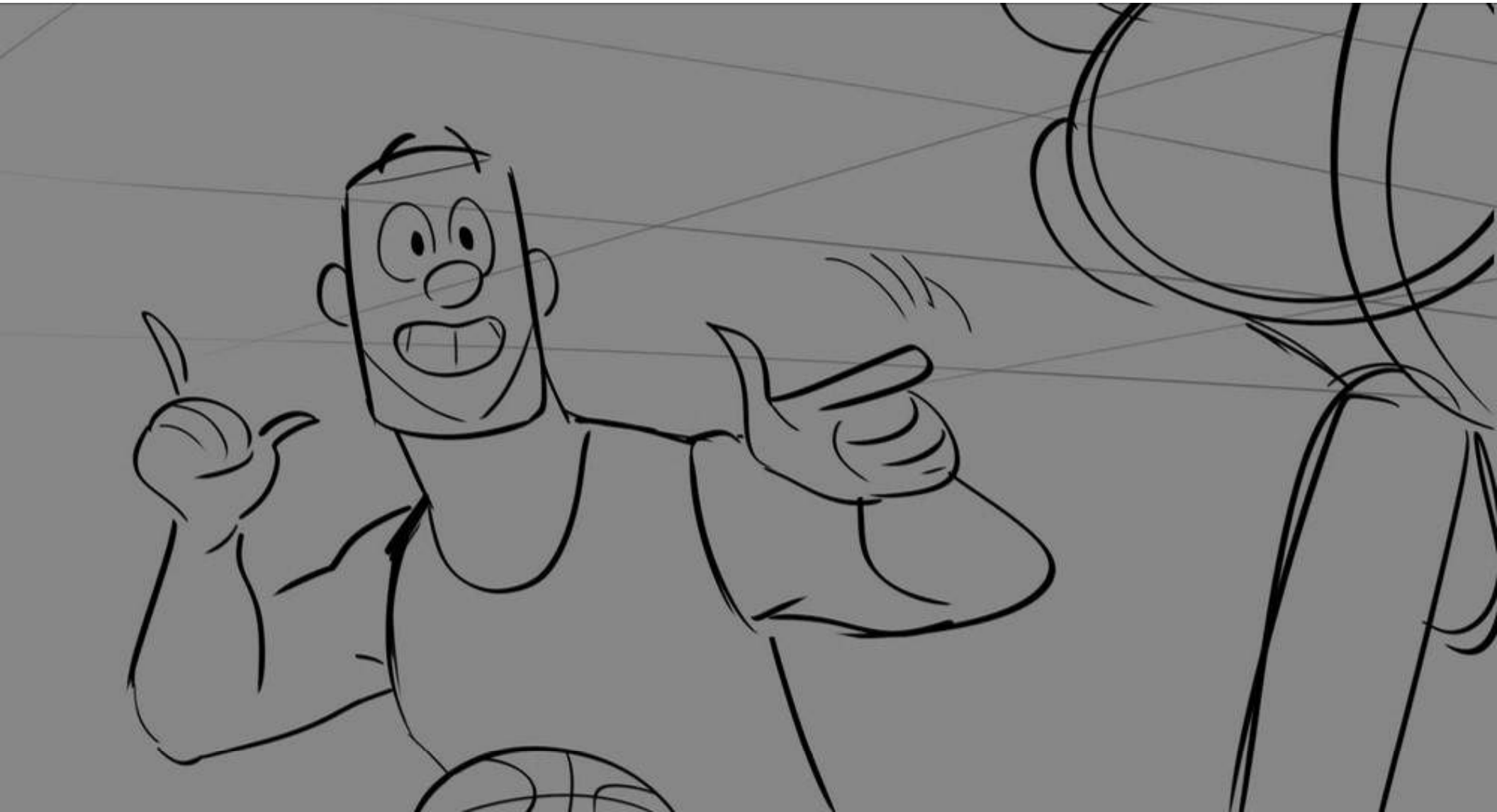



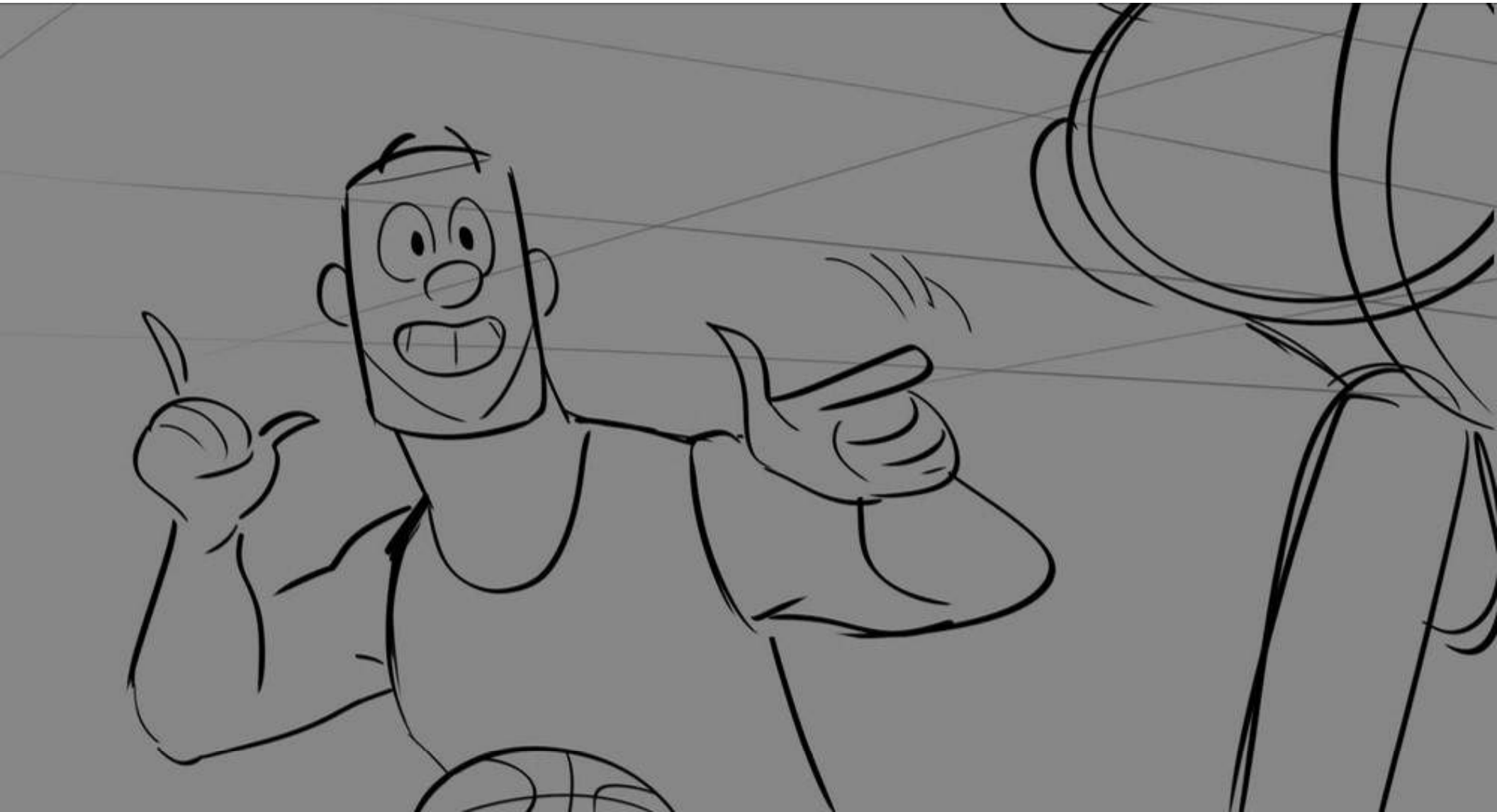

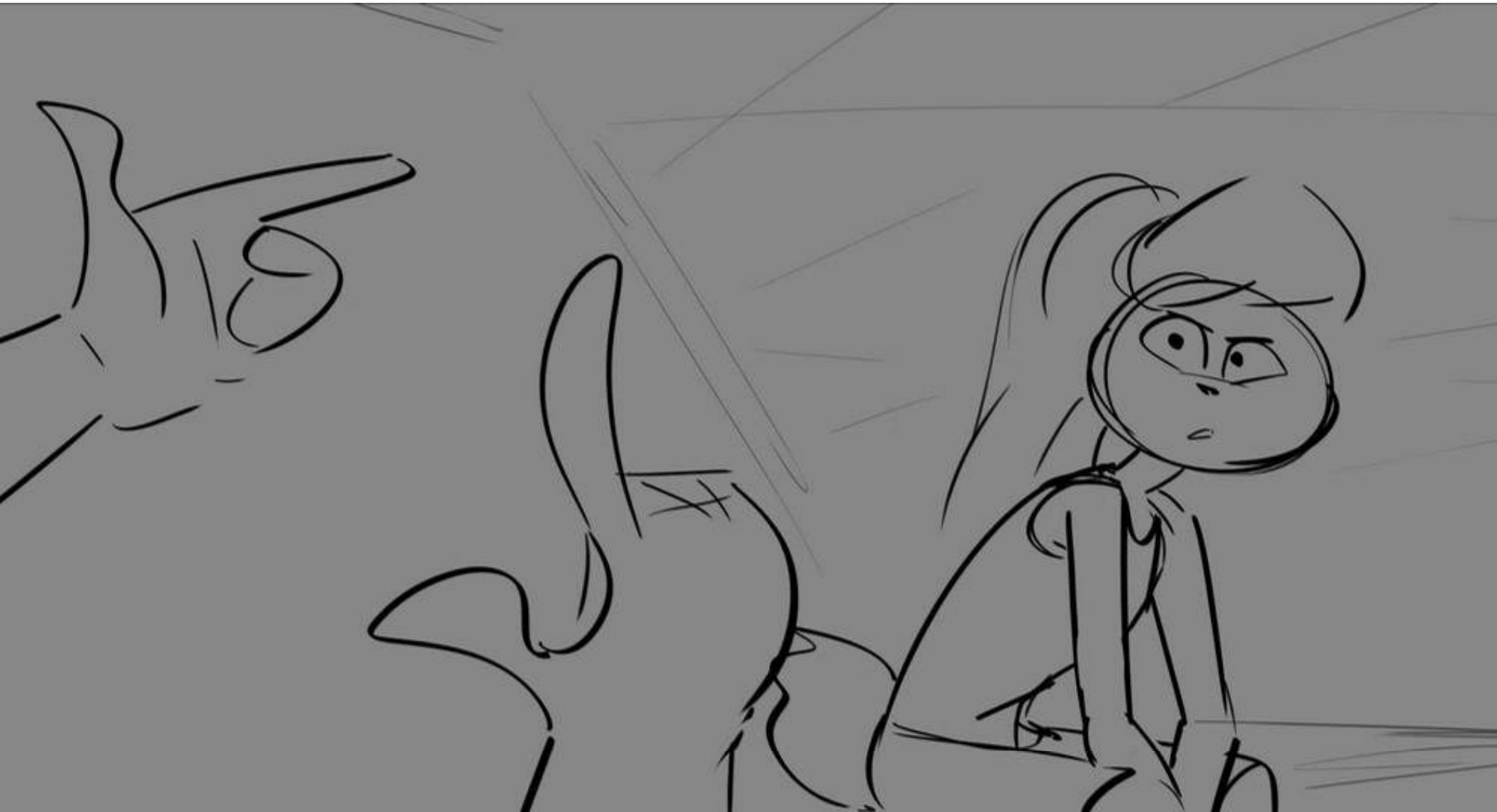

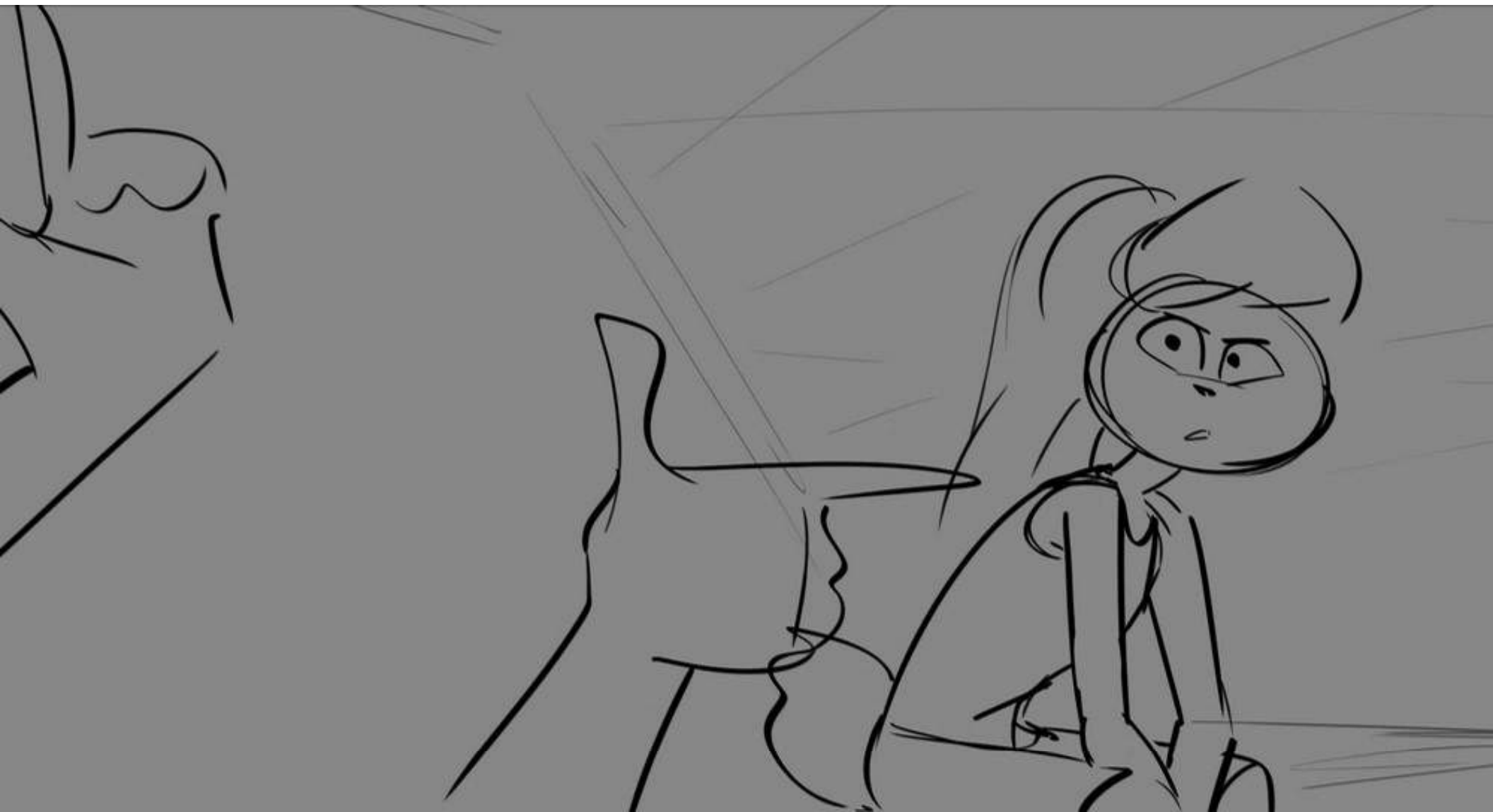

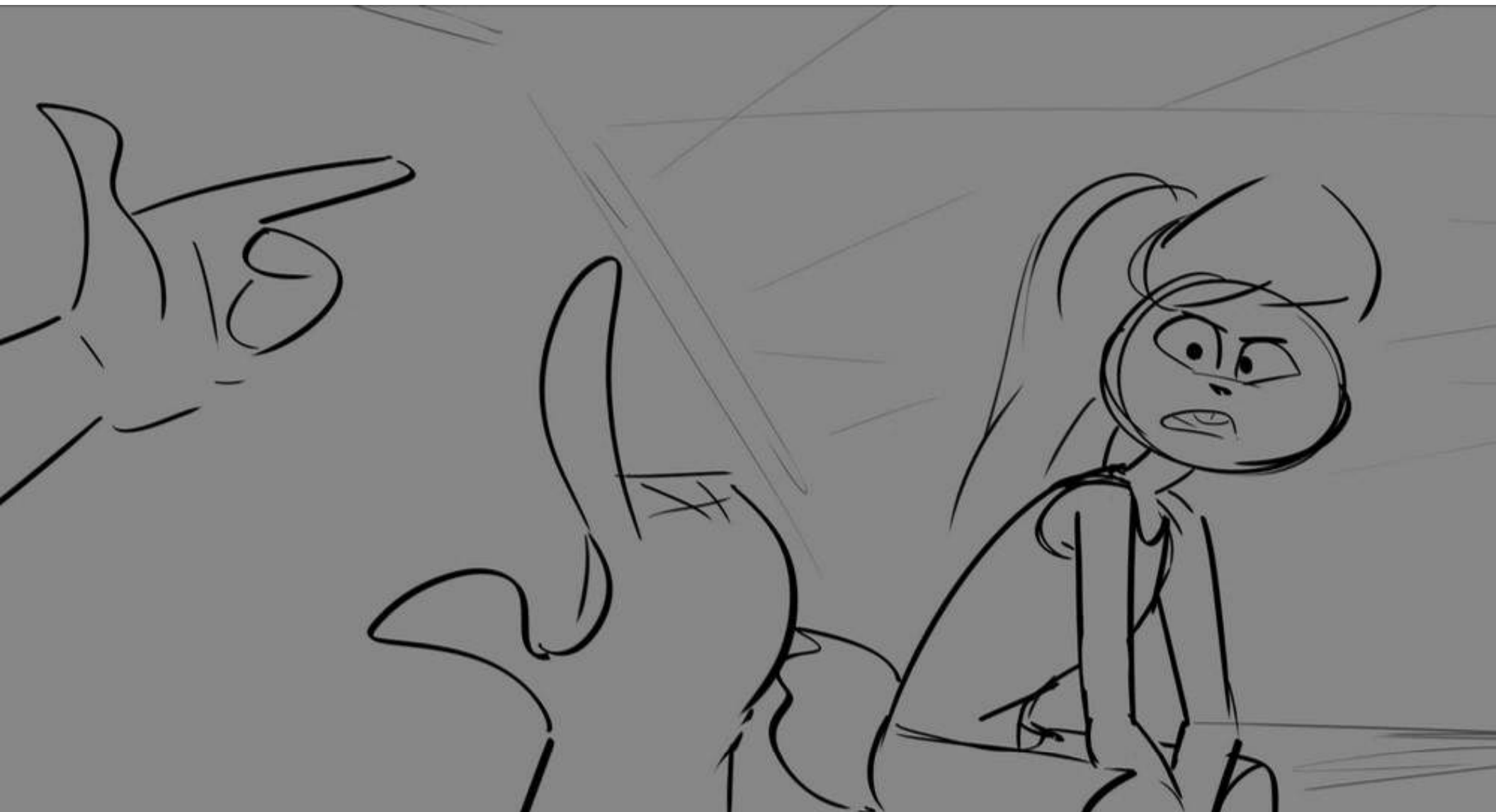

LOLA: This must be a 'dad joke.'

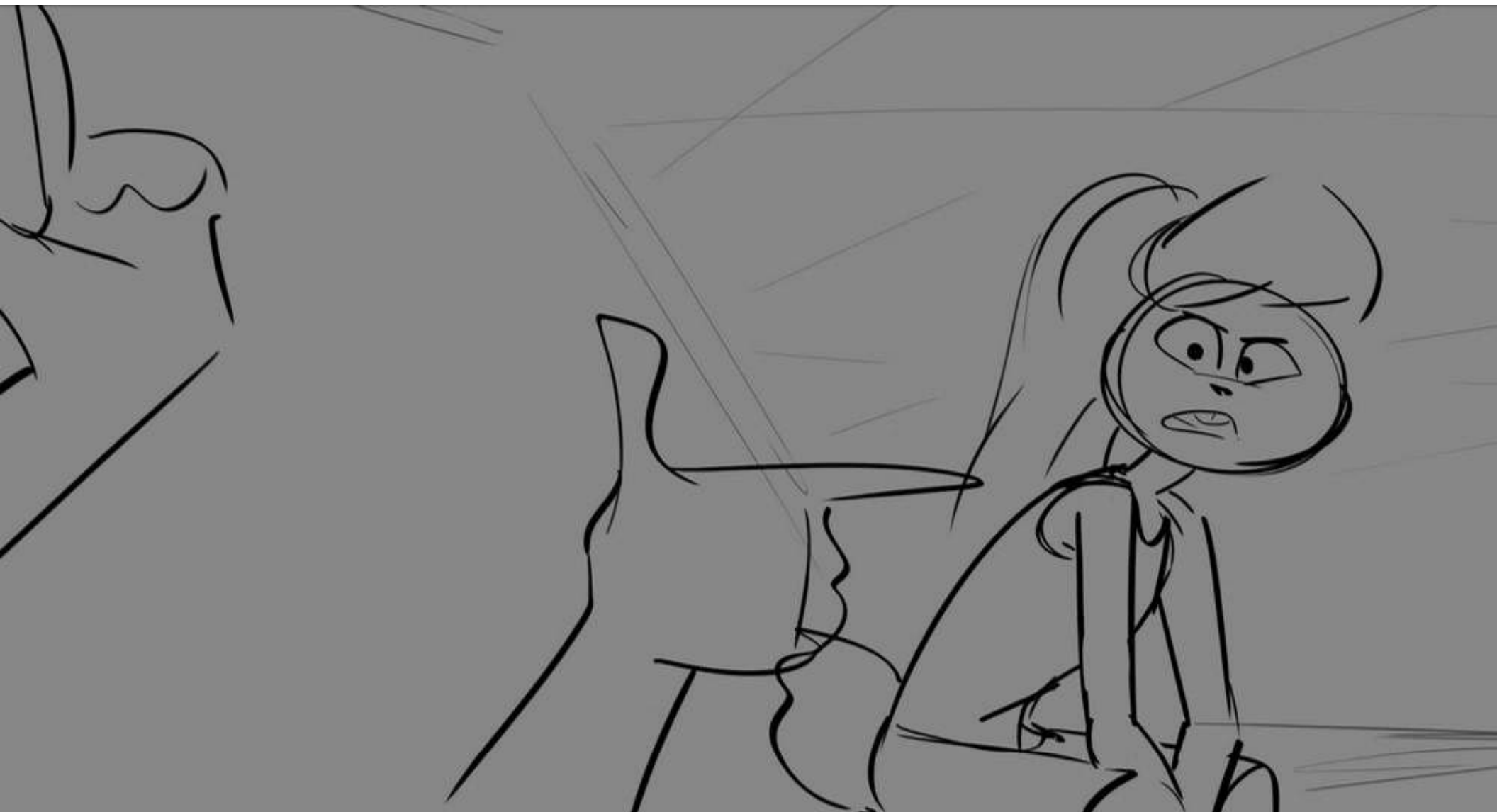

LOLA: This must be a 'dad joke.'

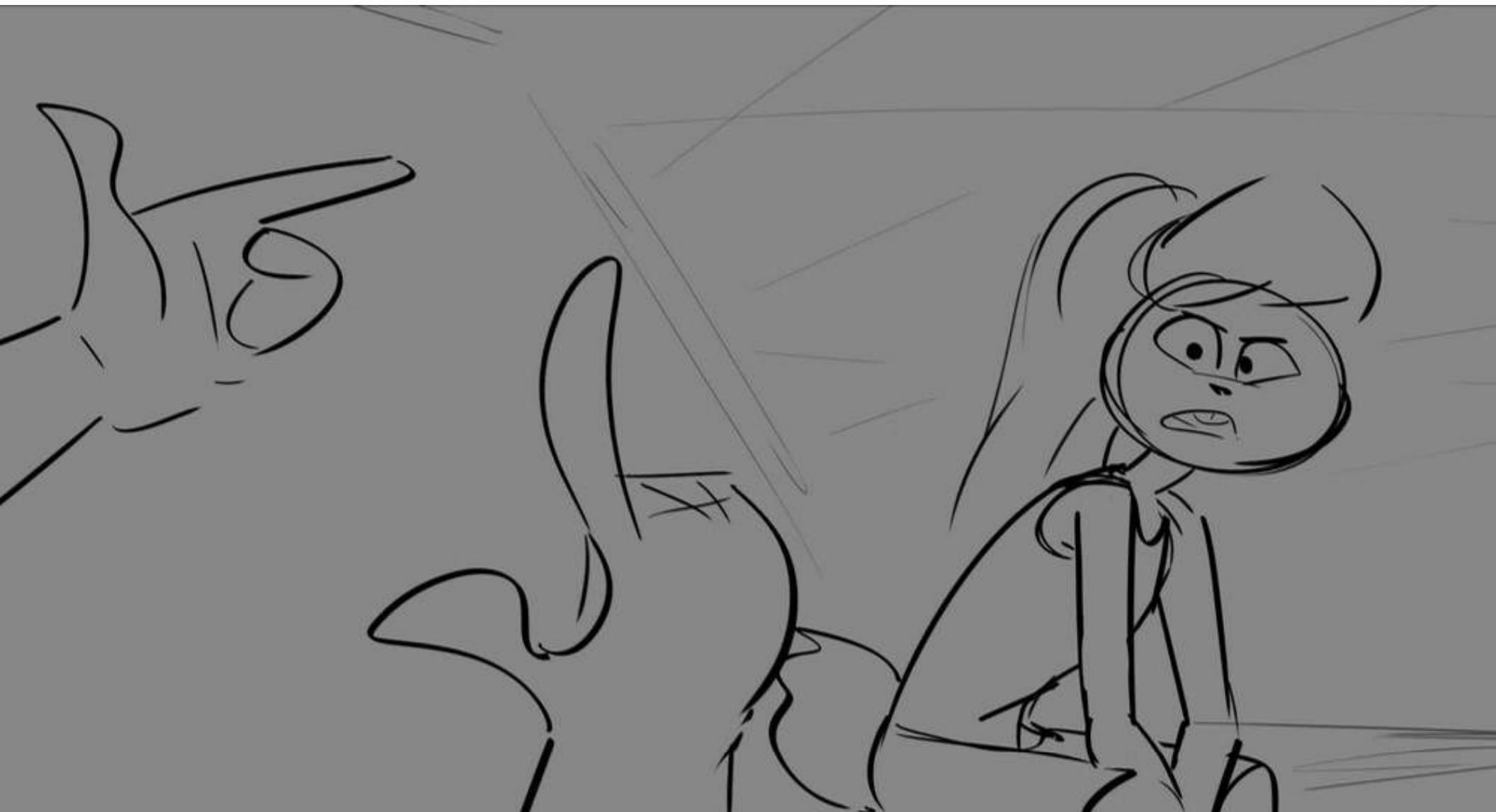

LOLA: This must be a 'dad joke.'

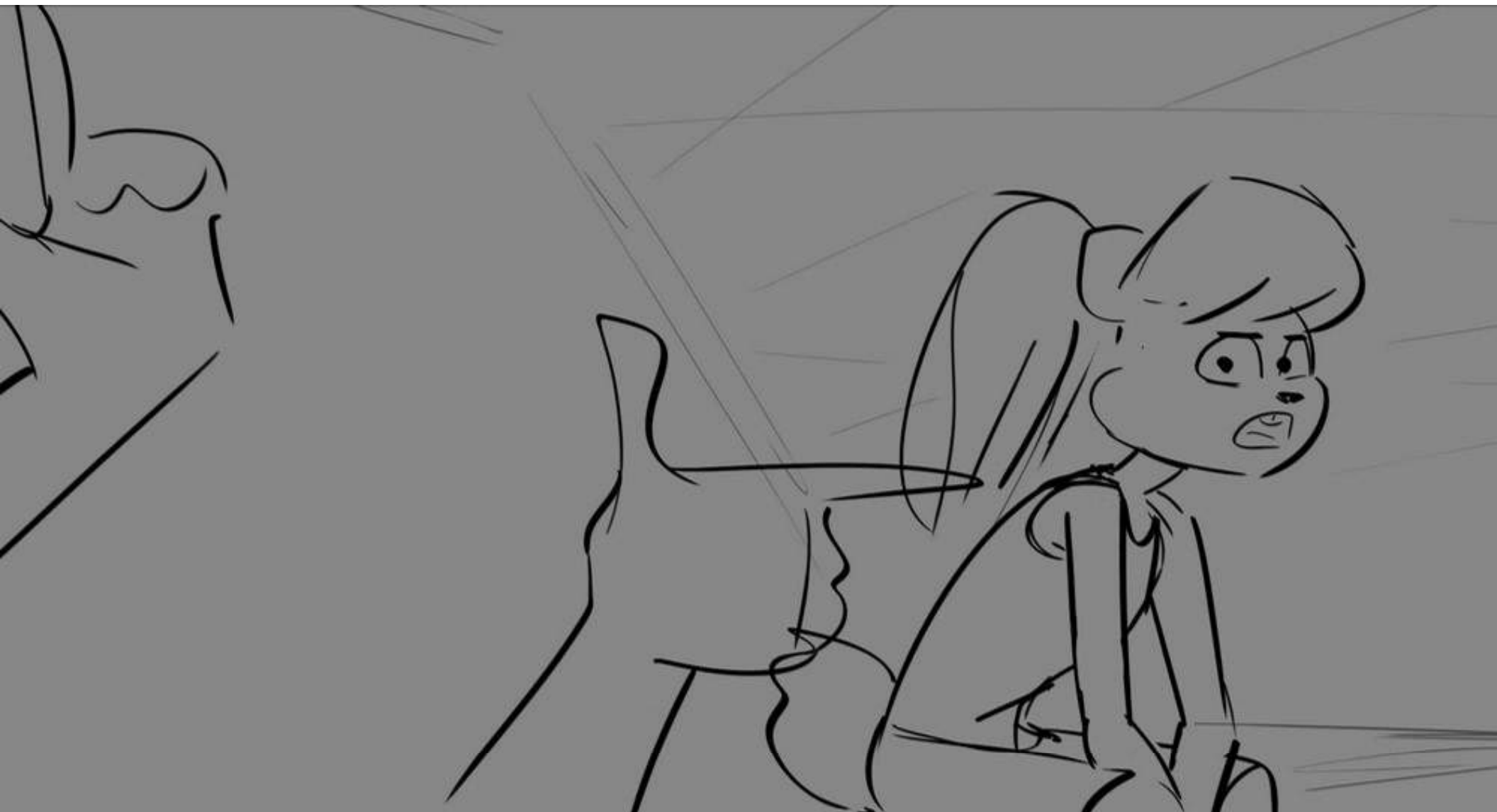

LOLA: I've heard of these.

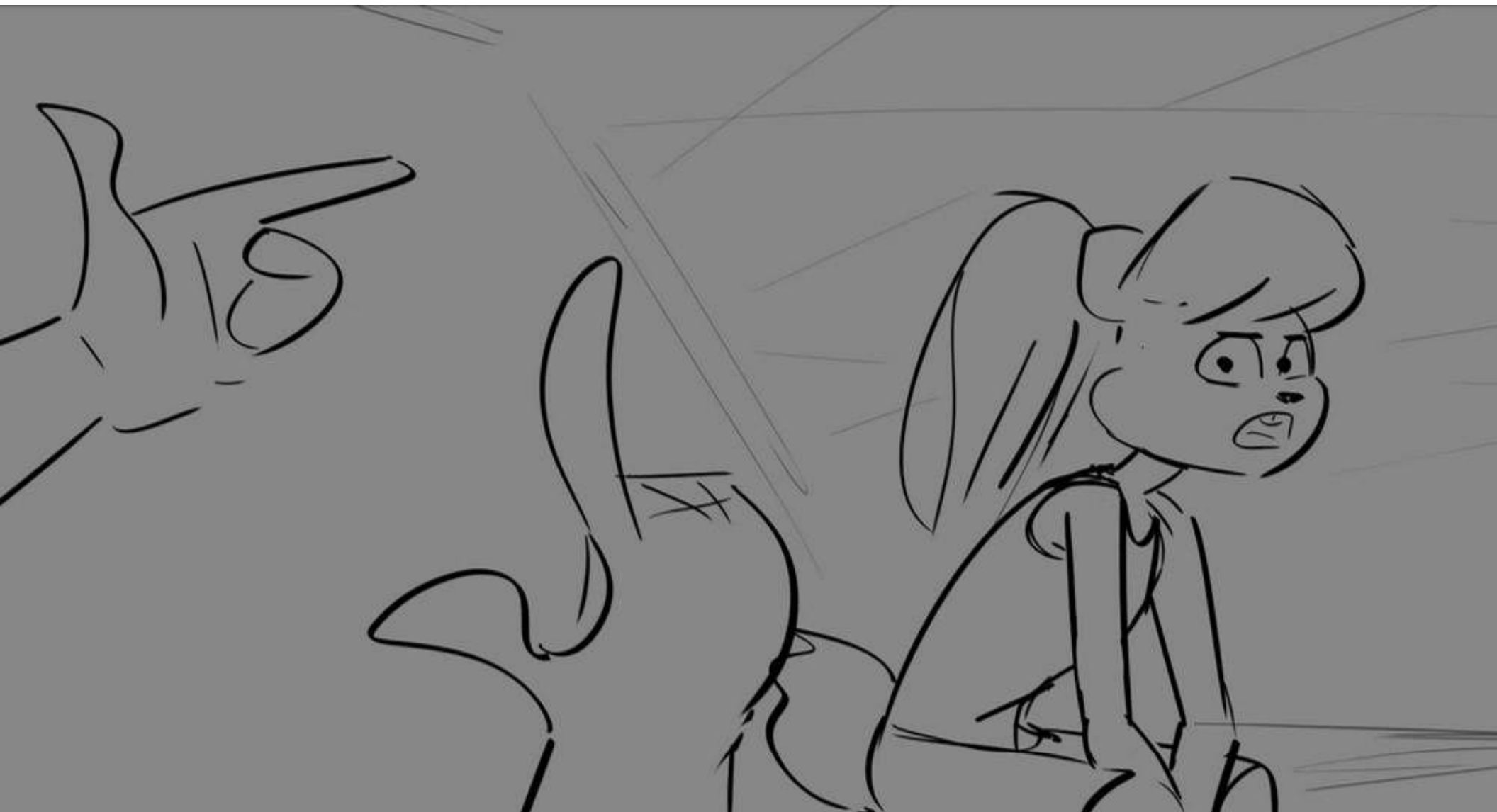

LOLA: I've heard of these.





LOLA: ...troubling.



LEBRON: Off the fire hydrant,

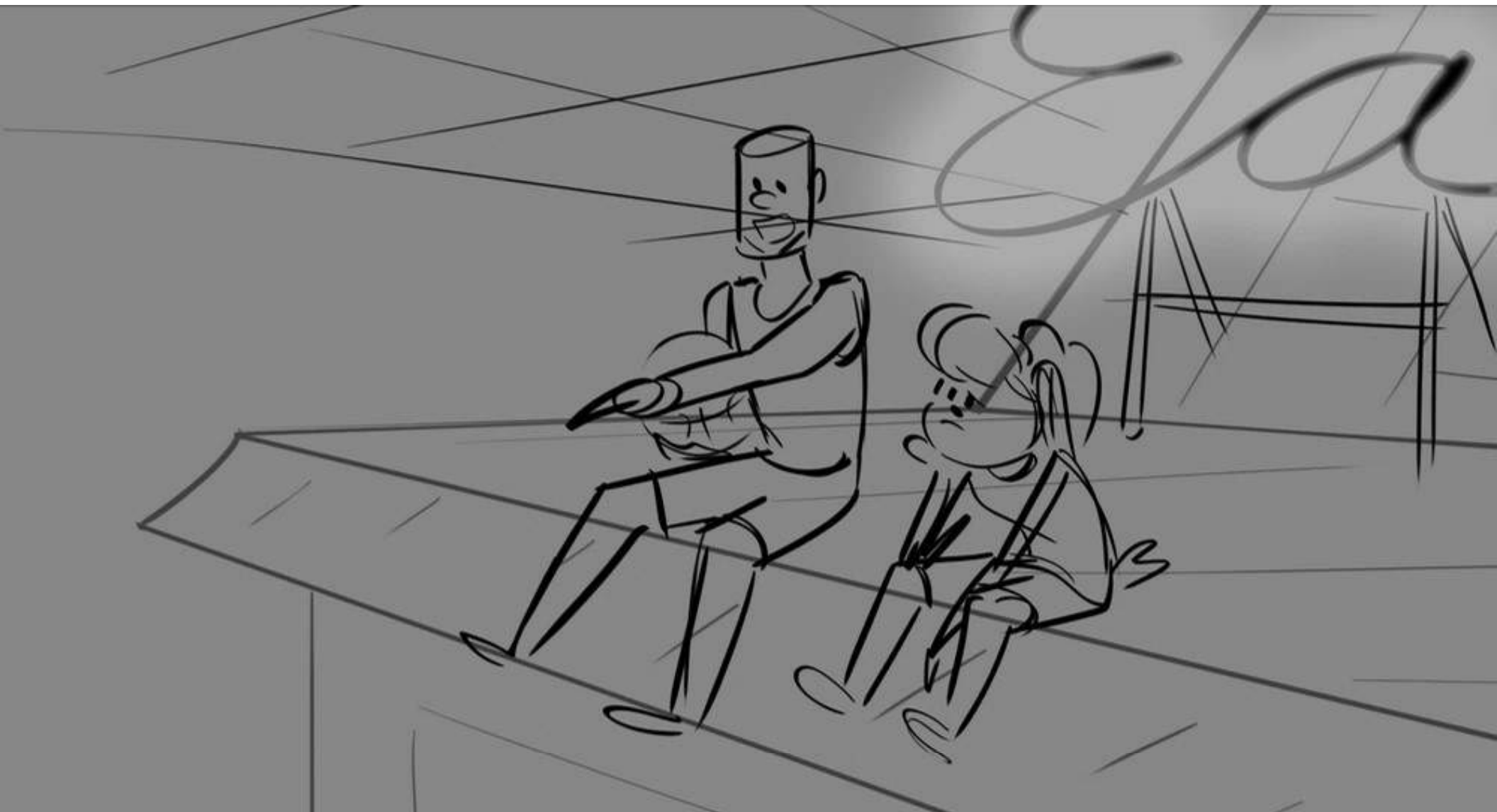

LEBRON: across the street,

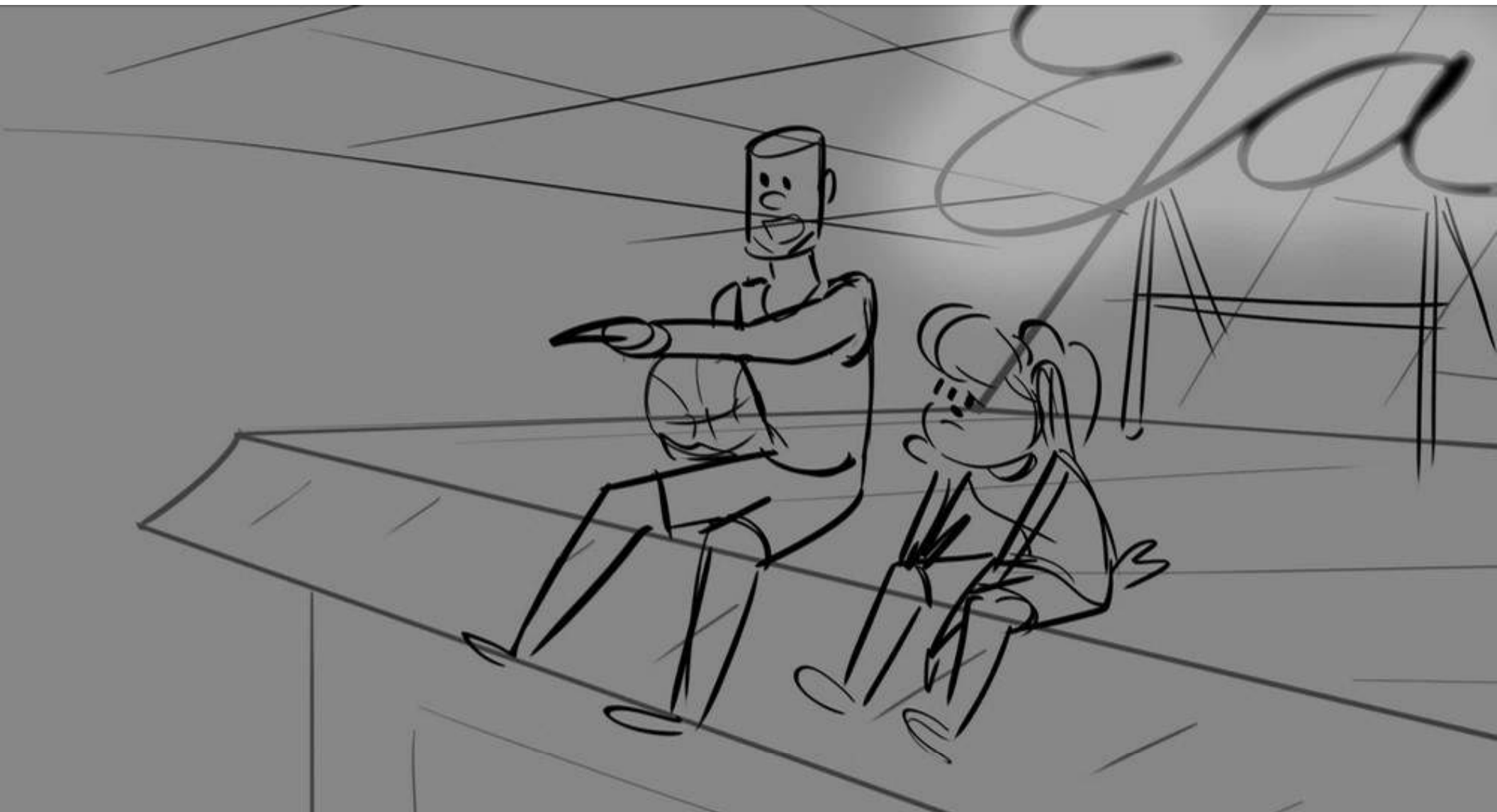

LEBRON: off the spaceship,

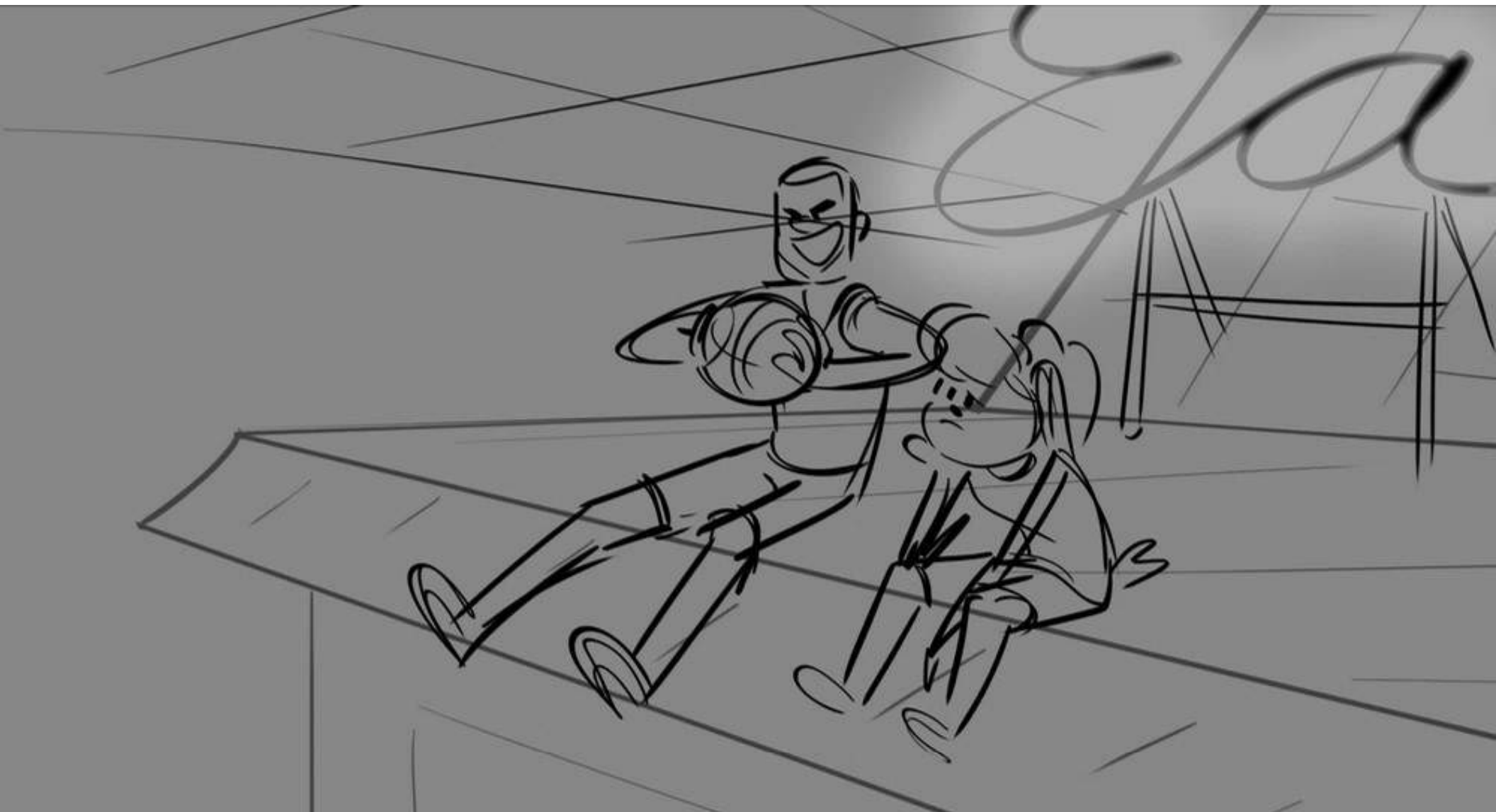

LEBRON: nothing but net.

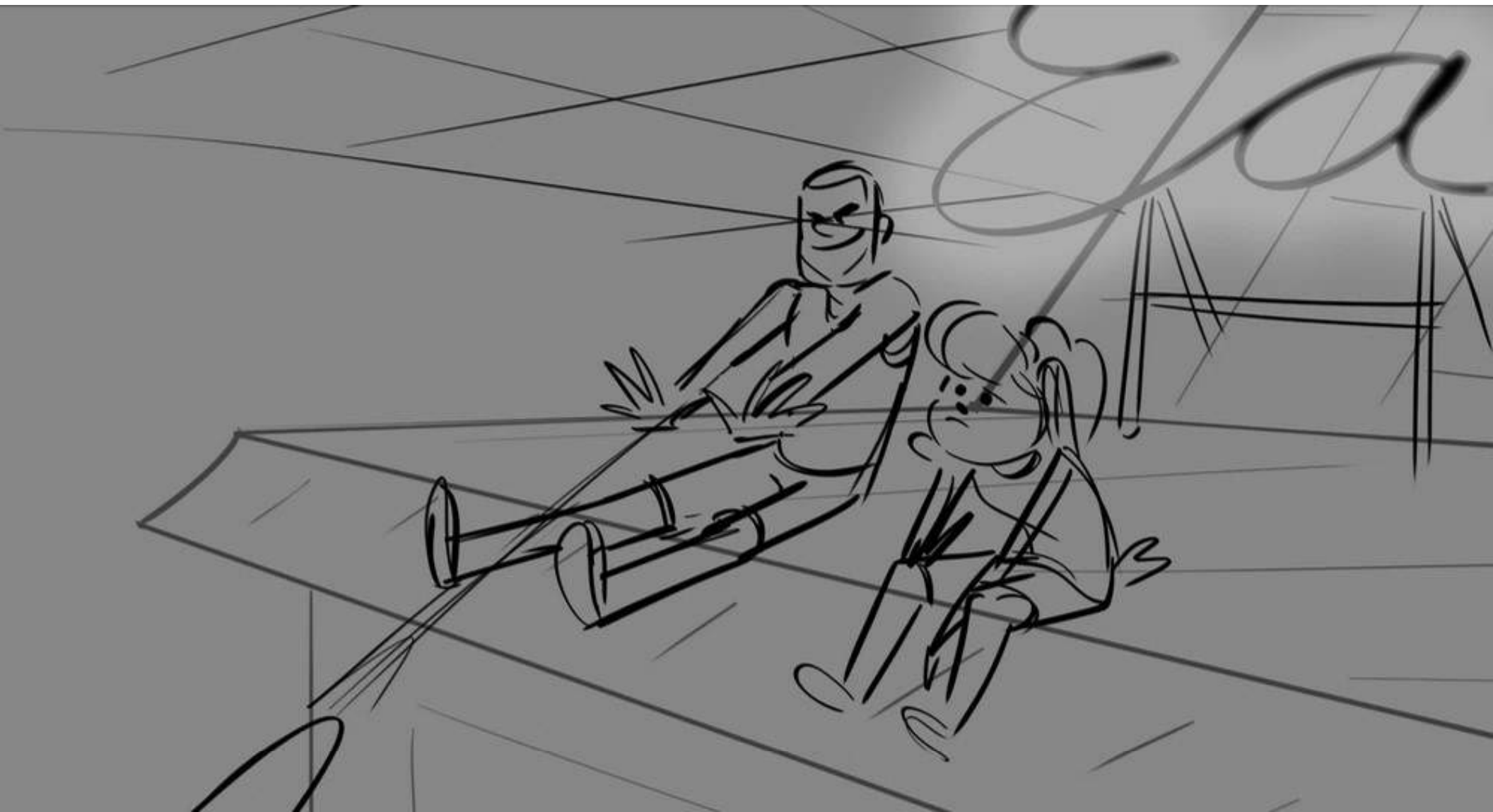

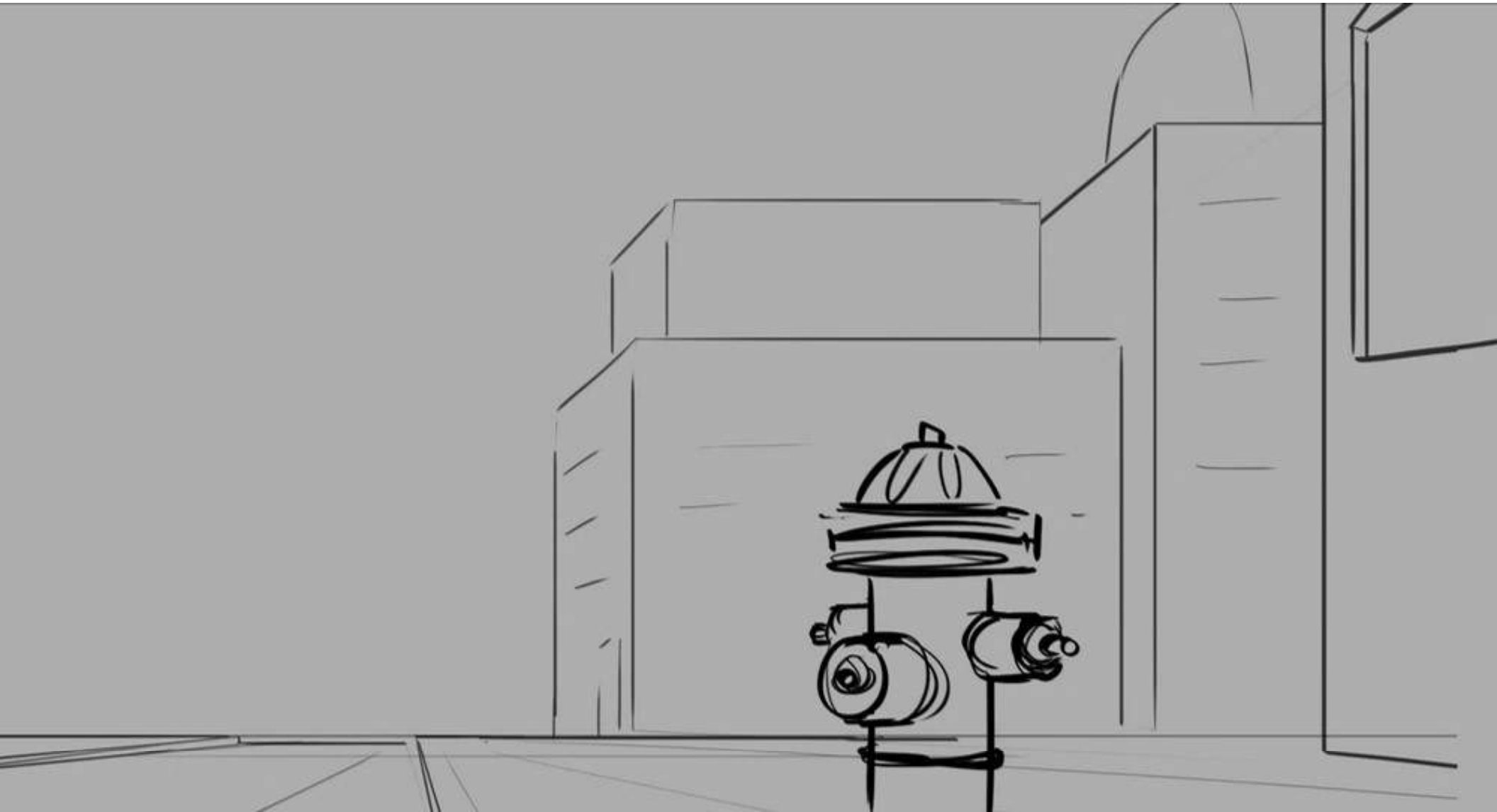

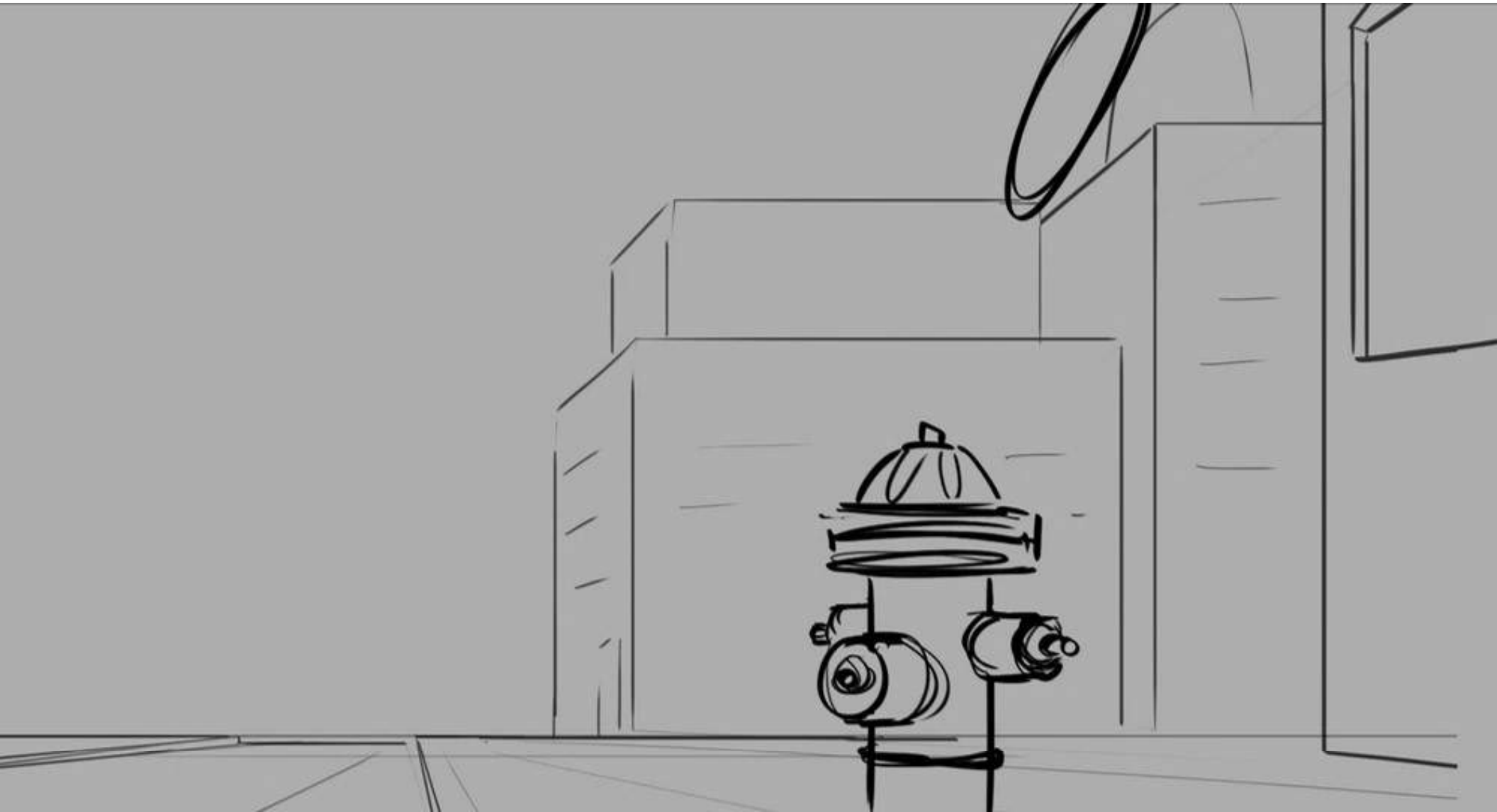

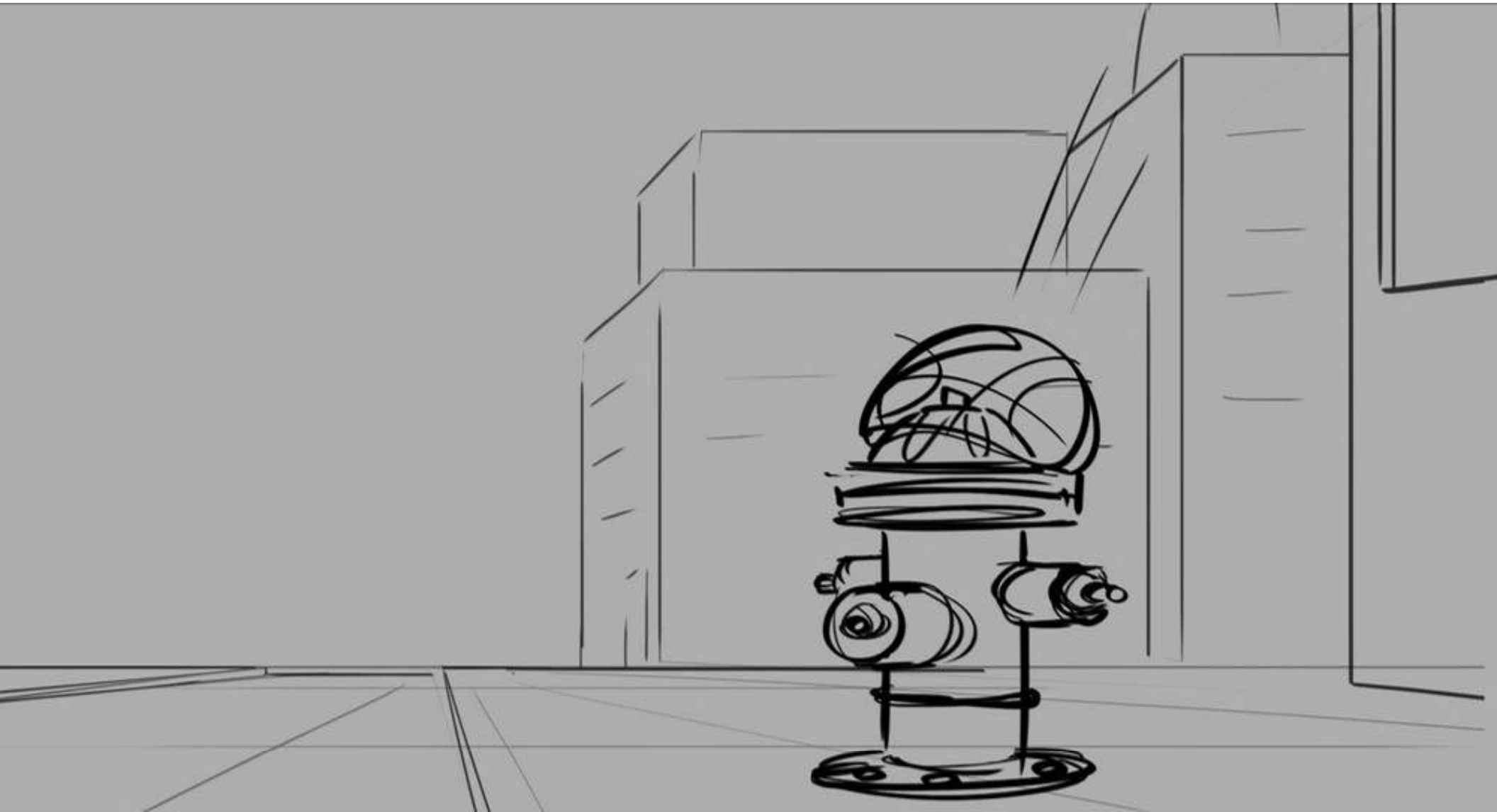

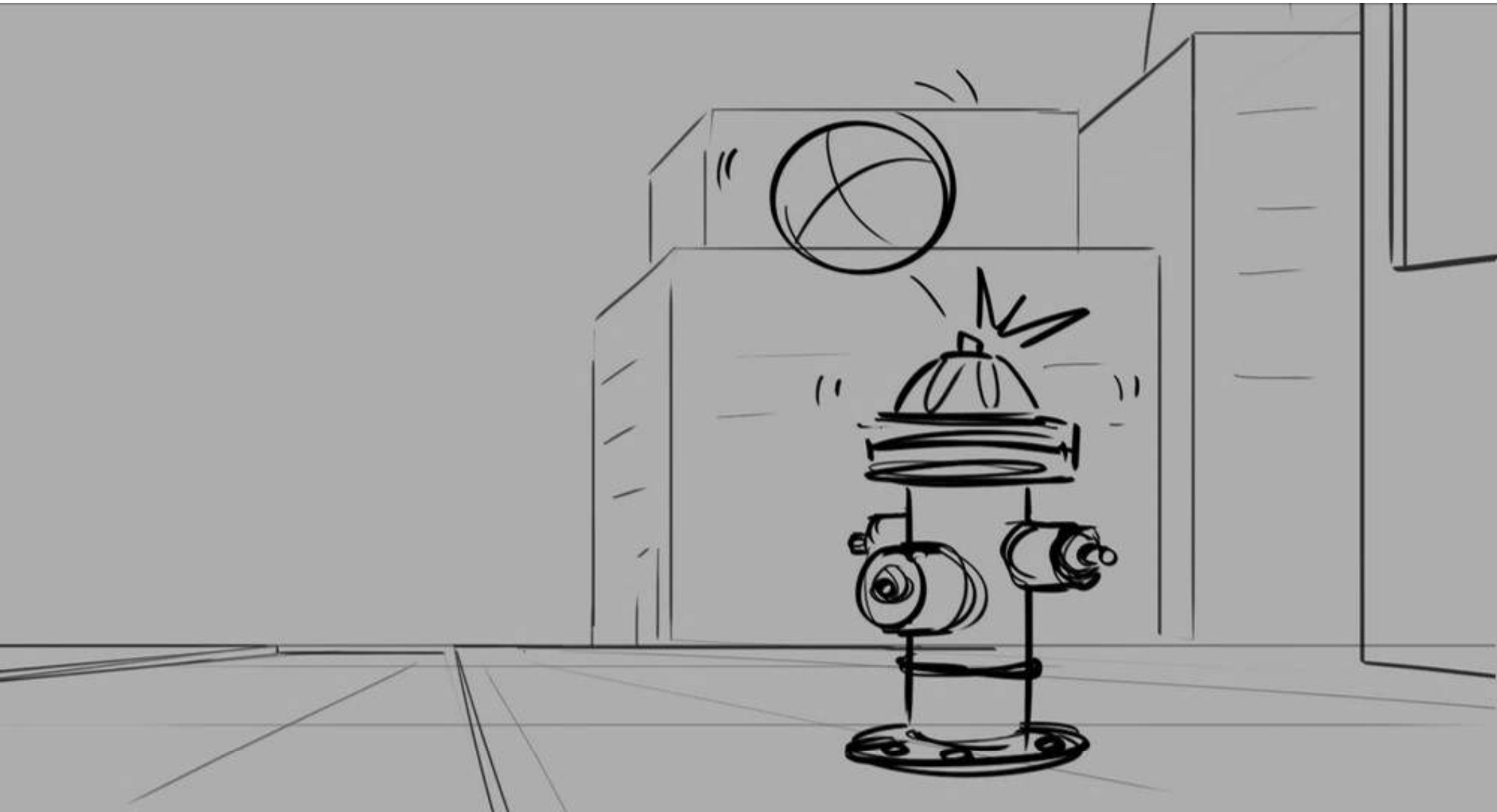

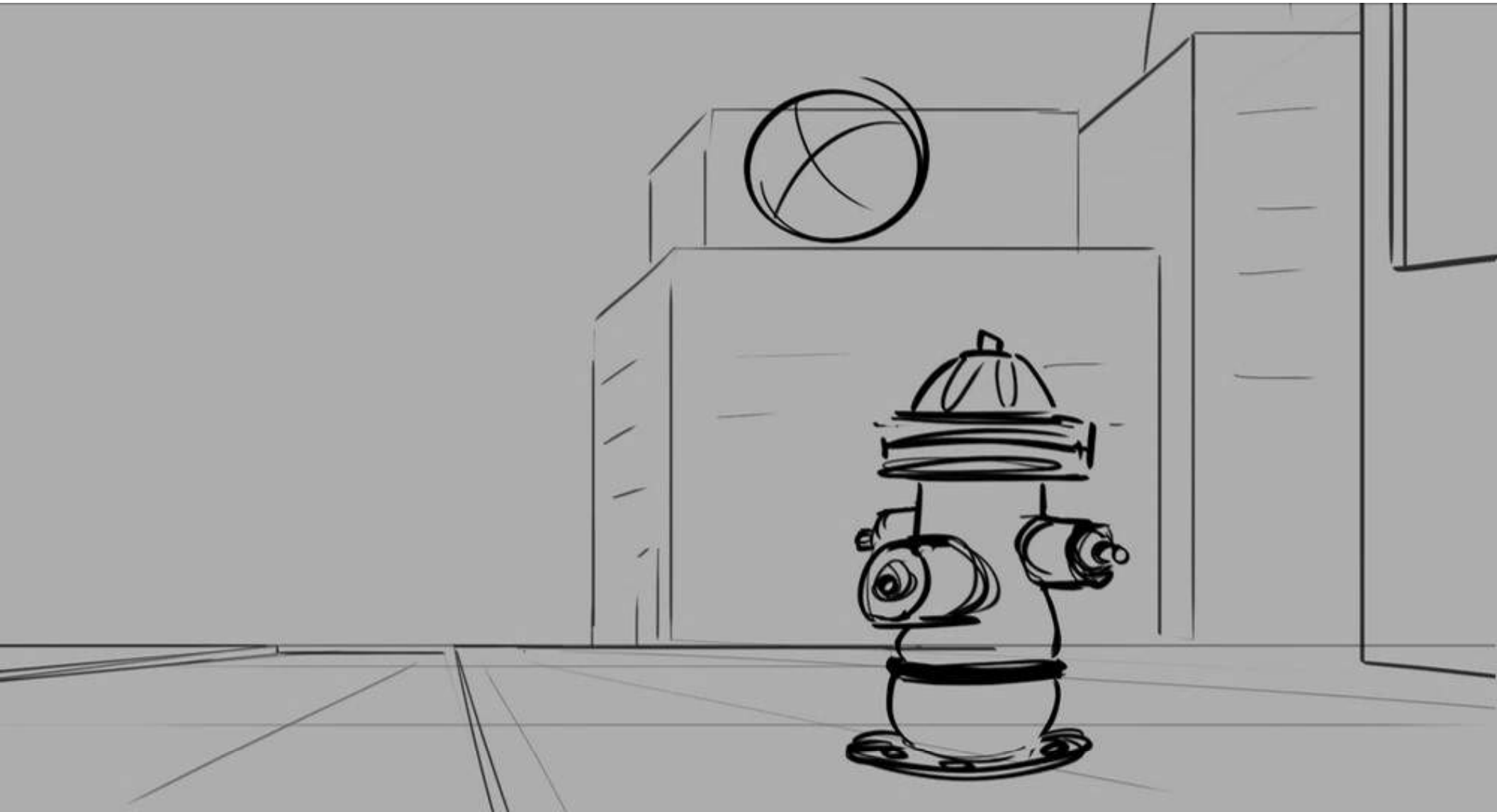

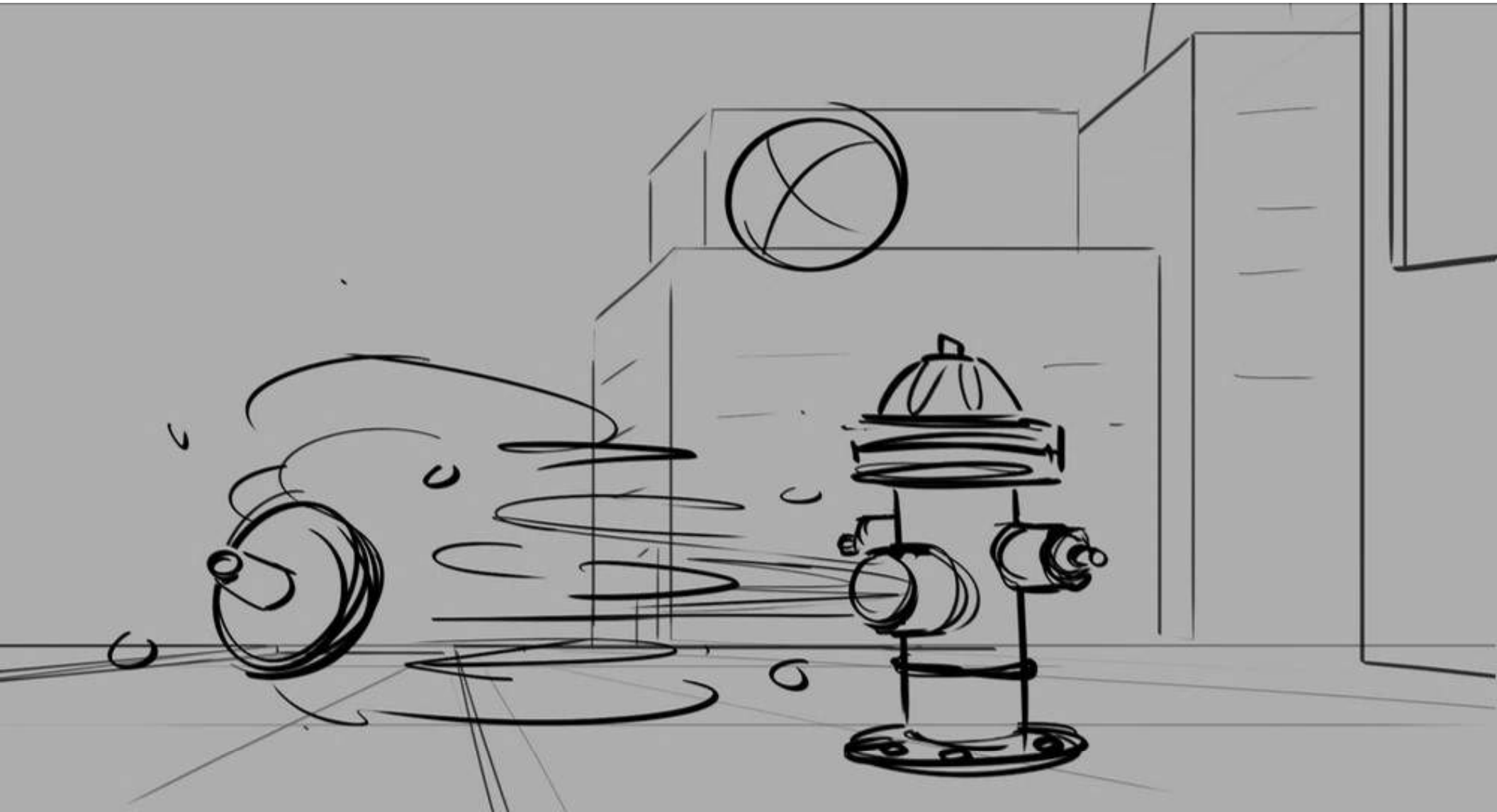

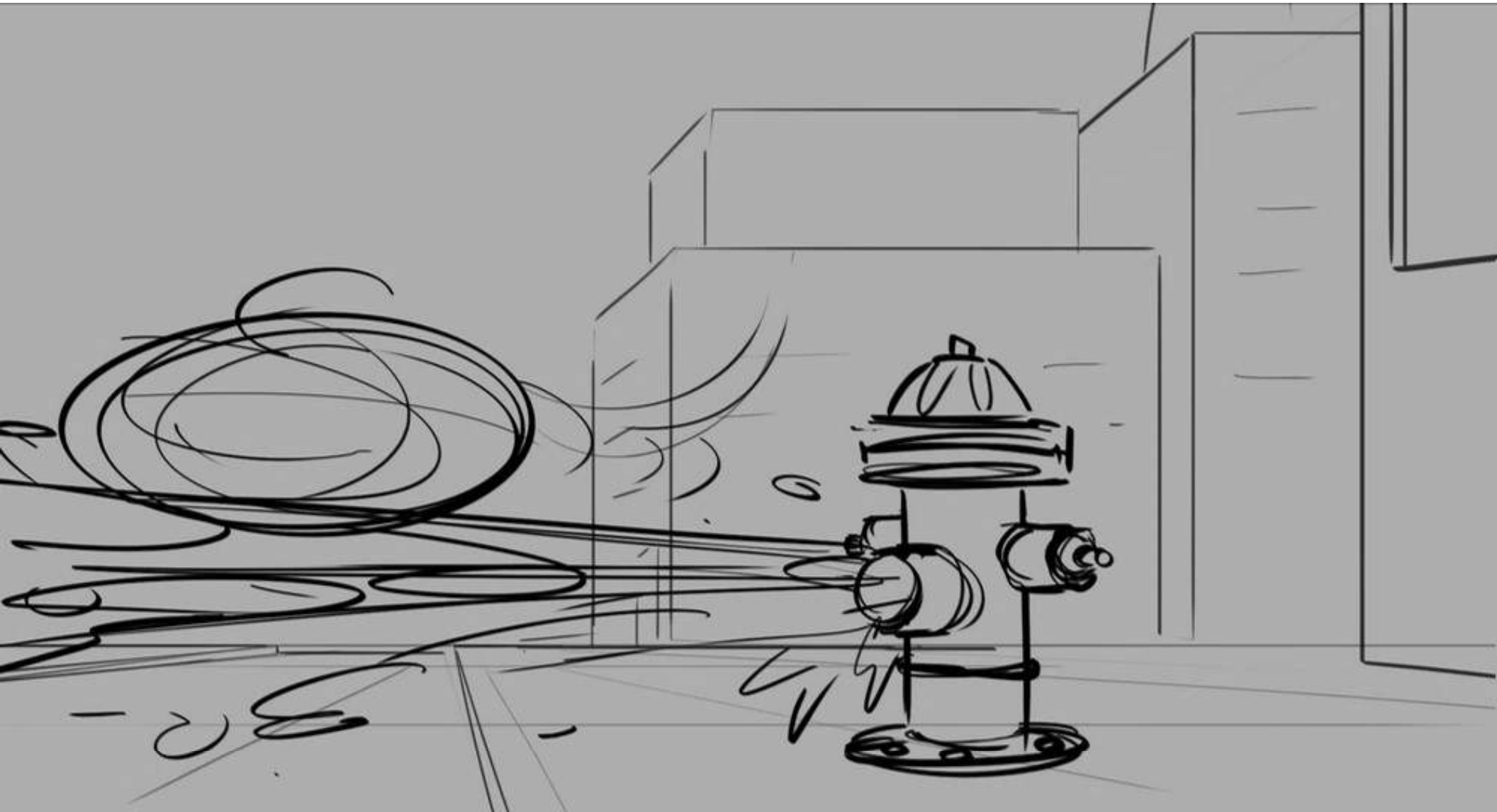

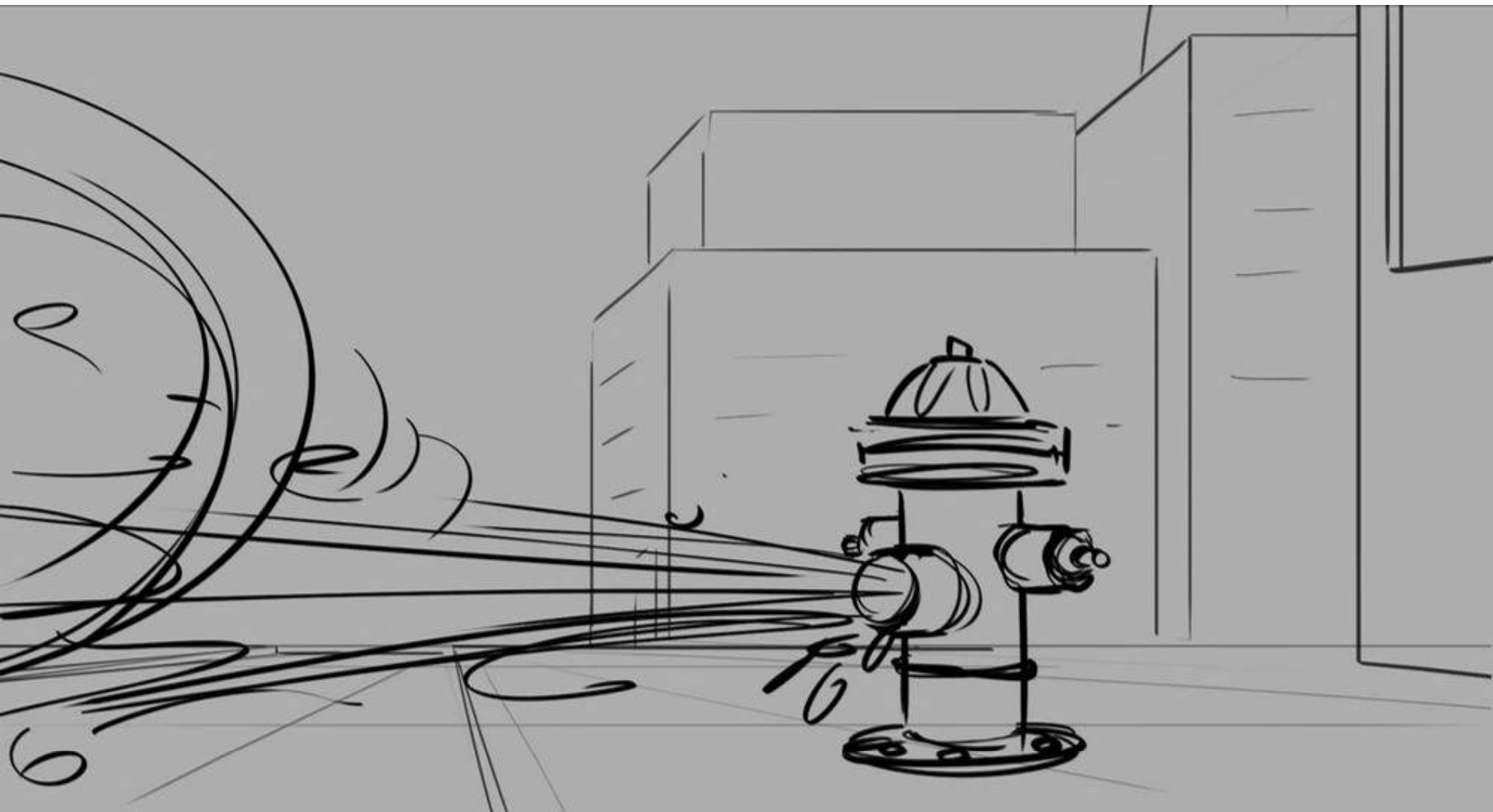

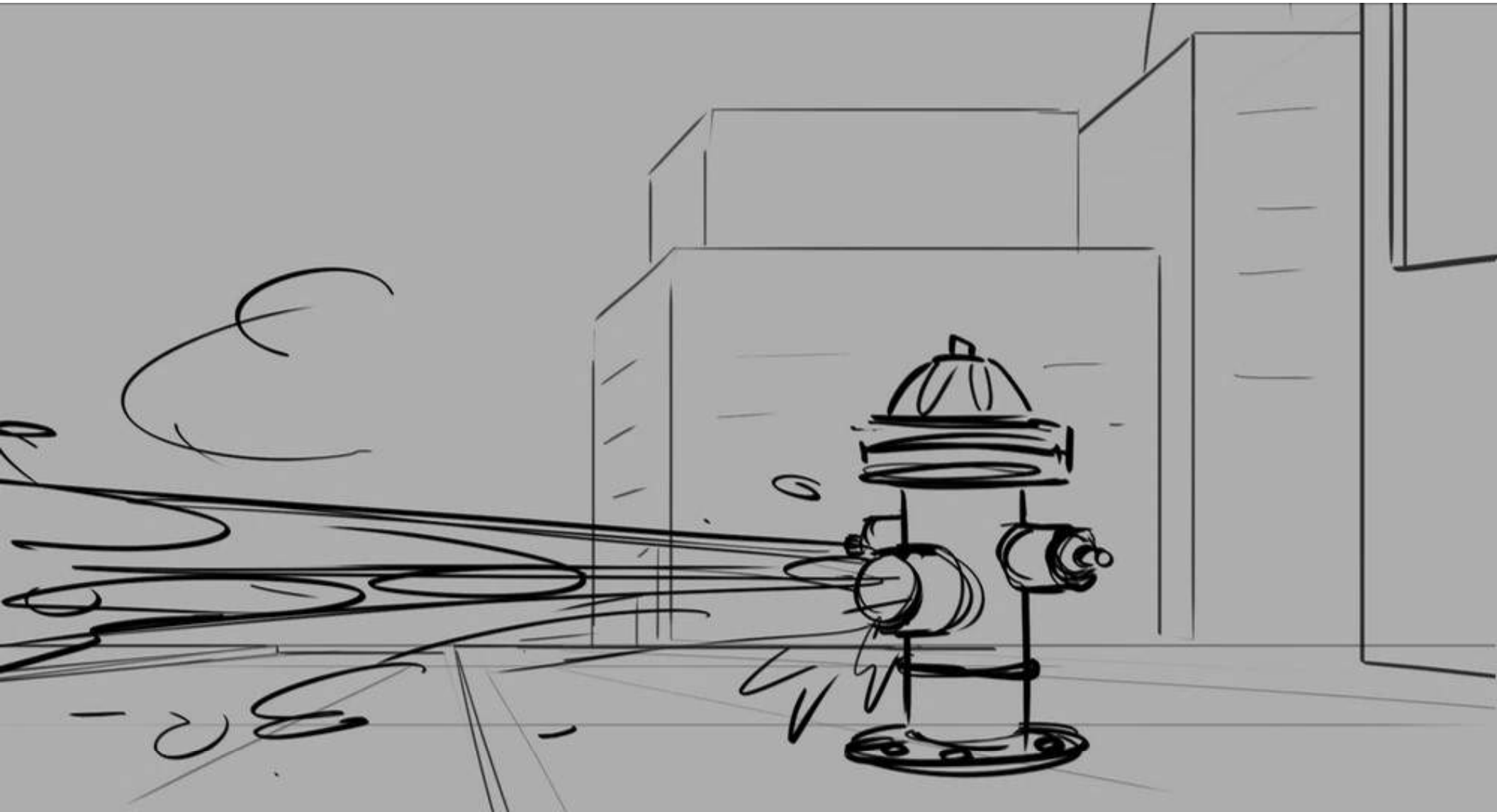

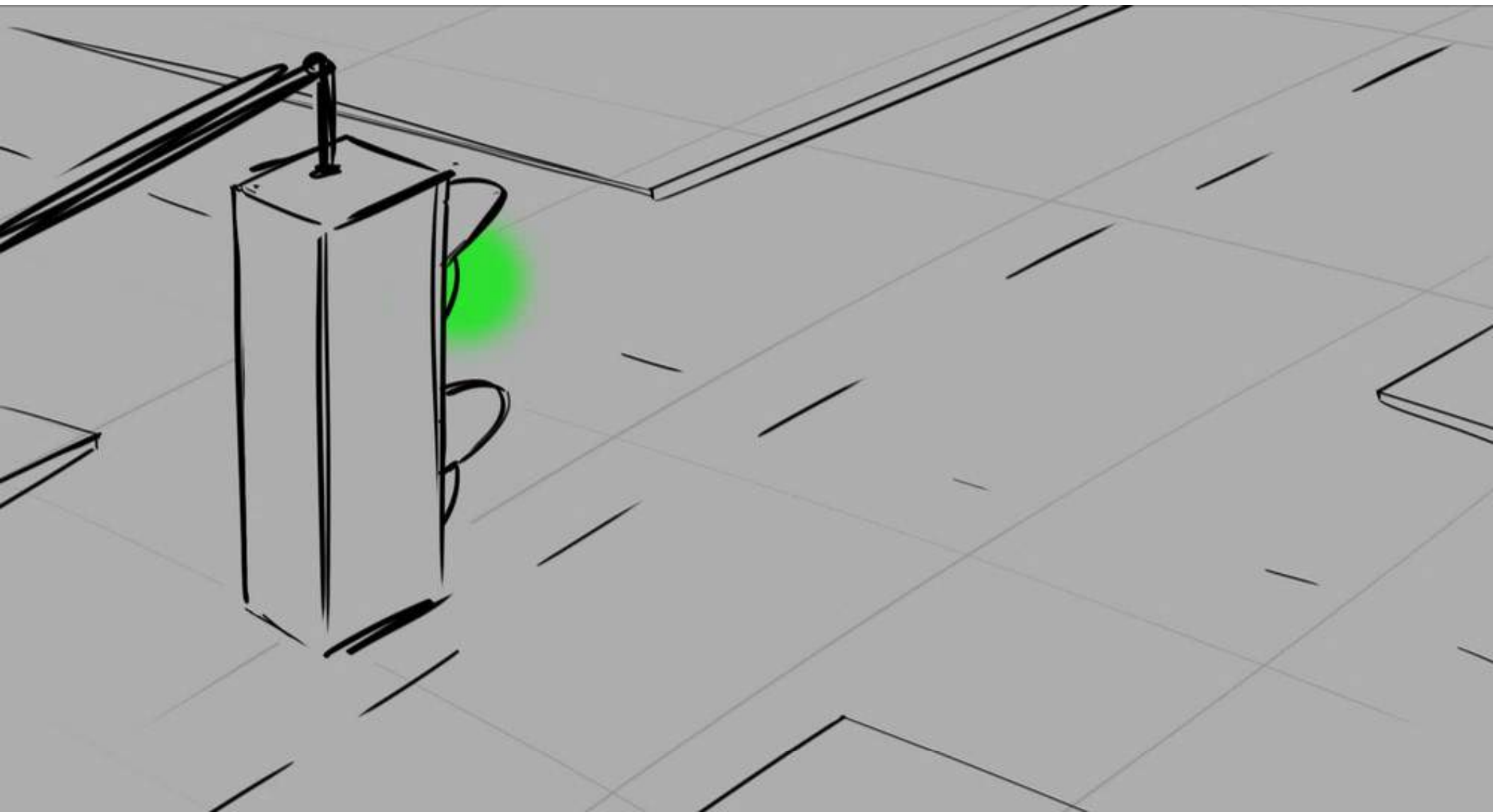

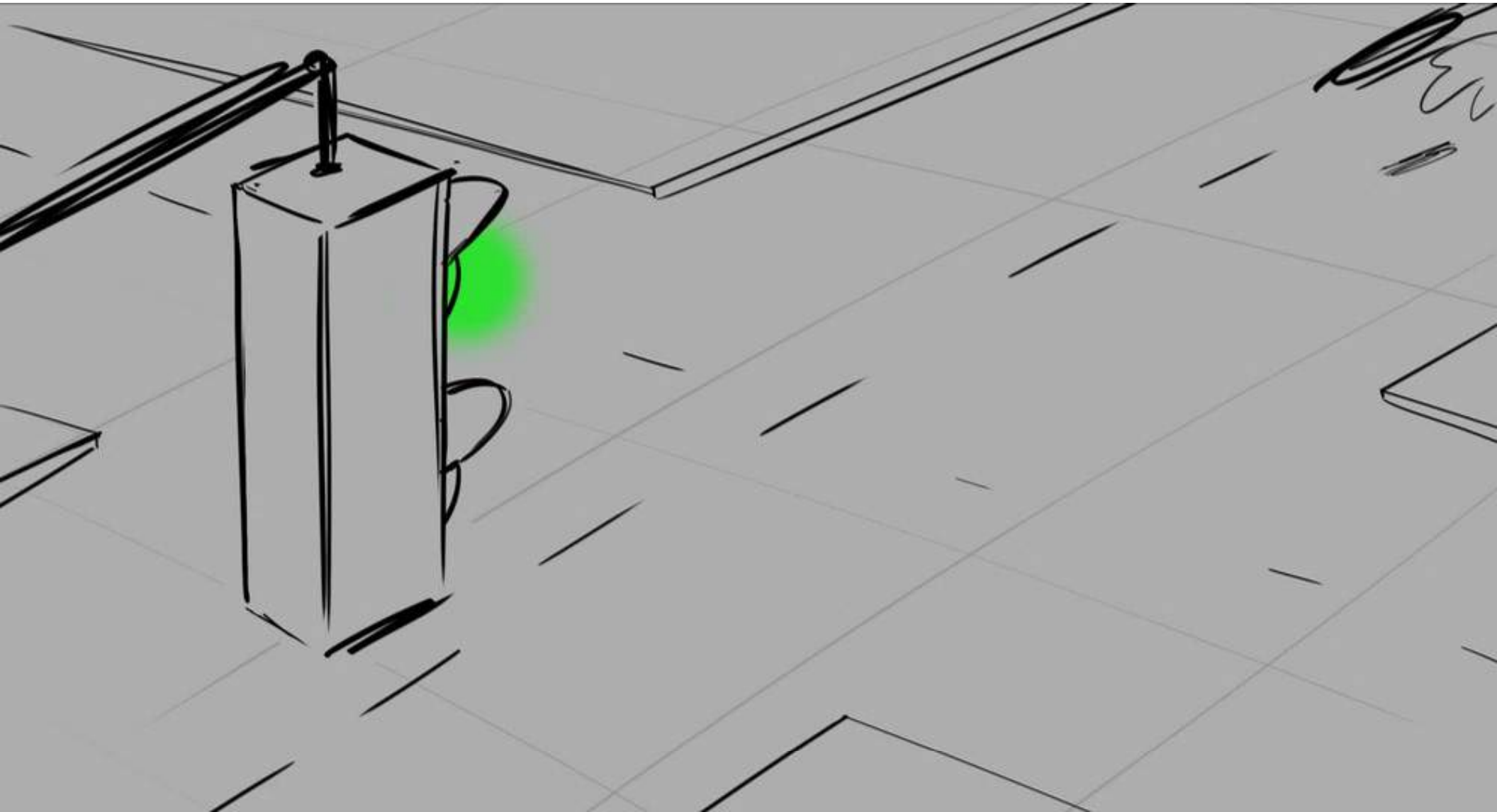

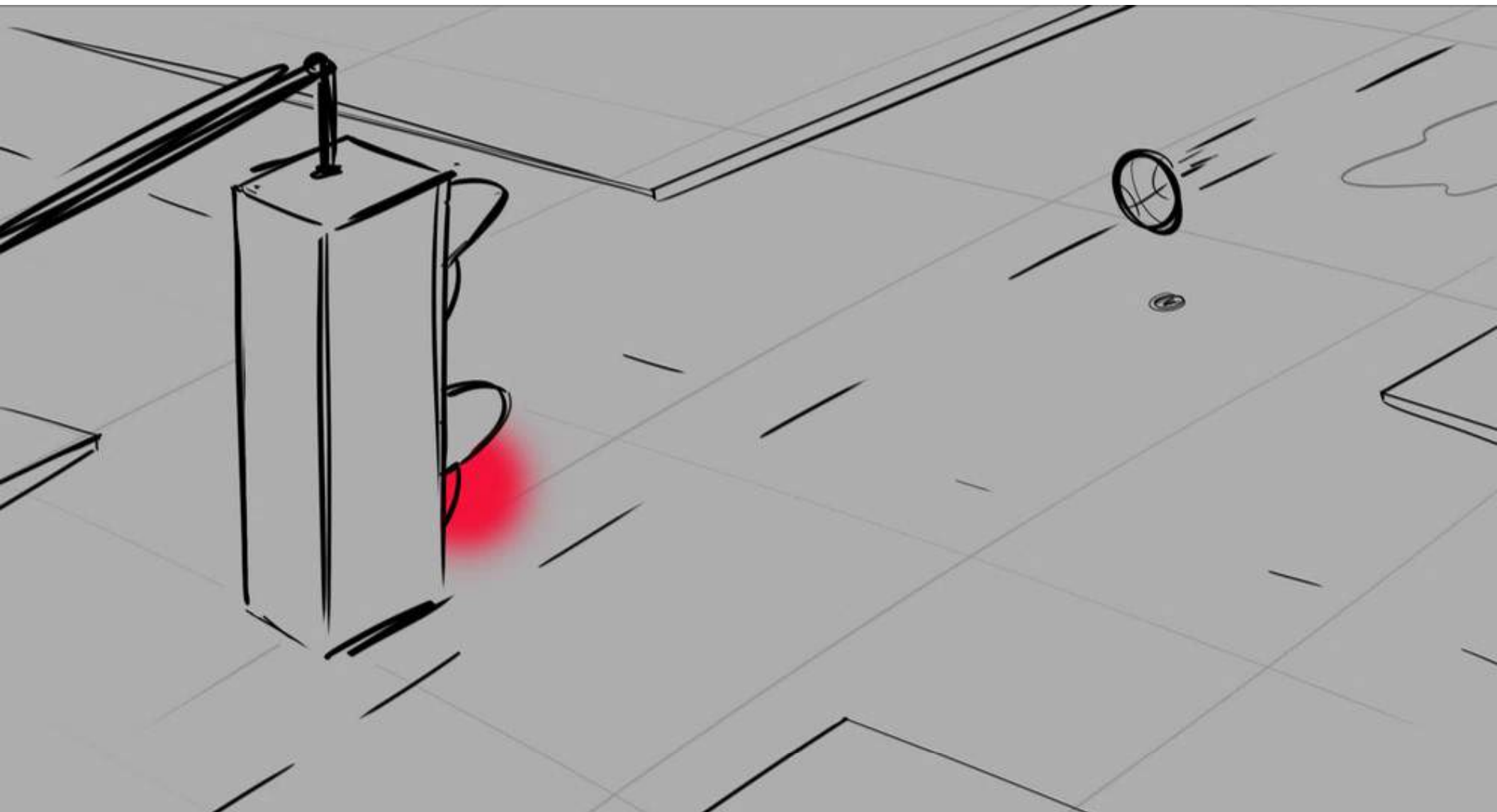

SFX: tires screeching

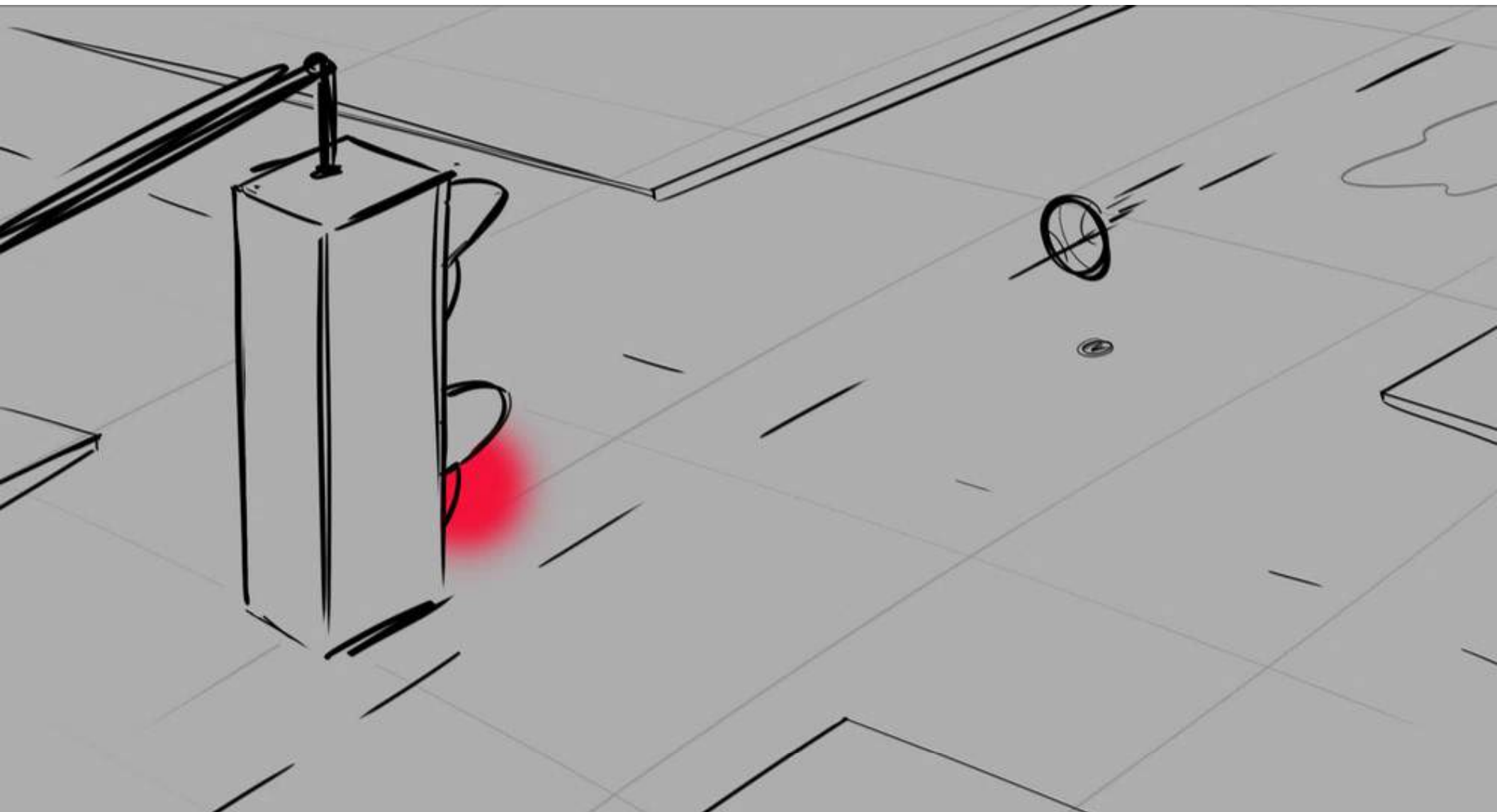

SFX: tires screeching

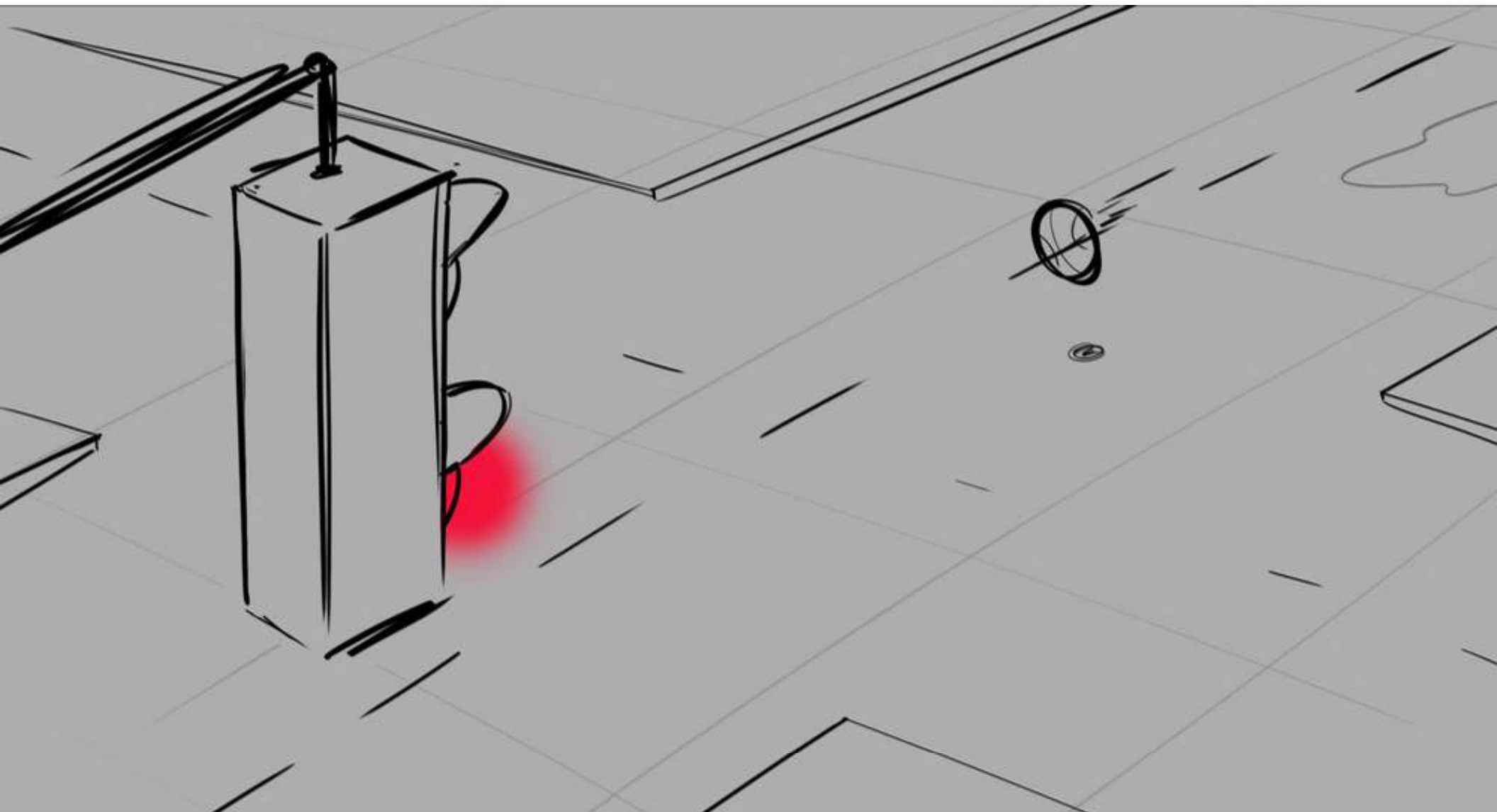

SFX: tires screeching

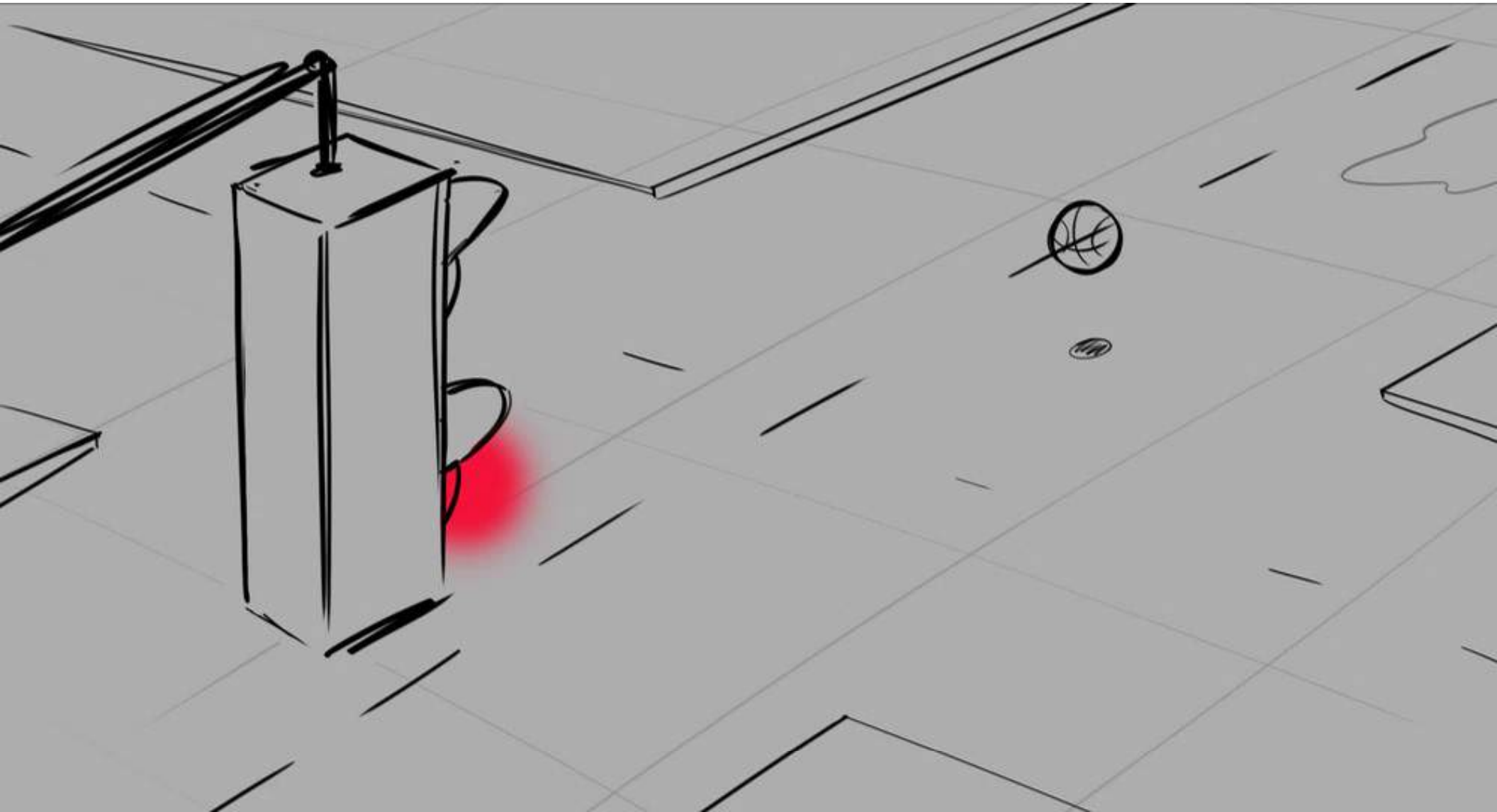

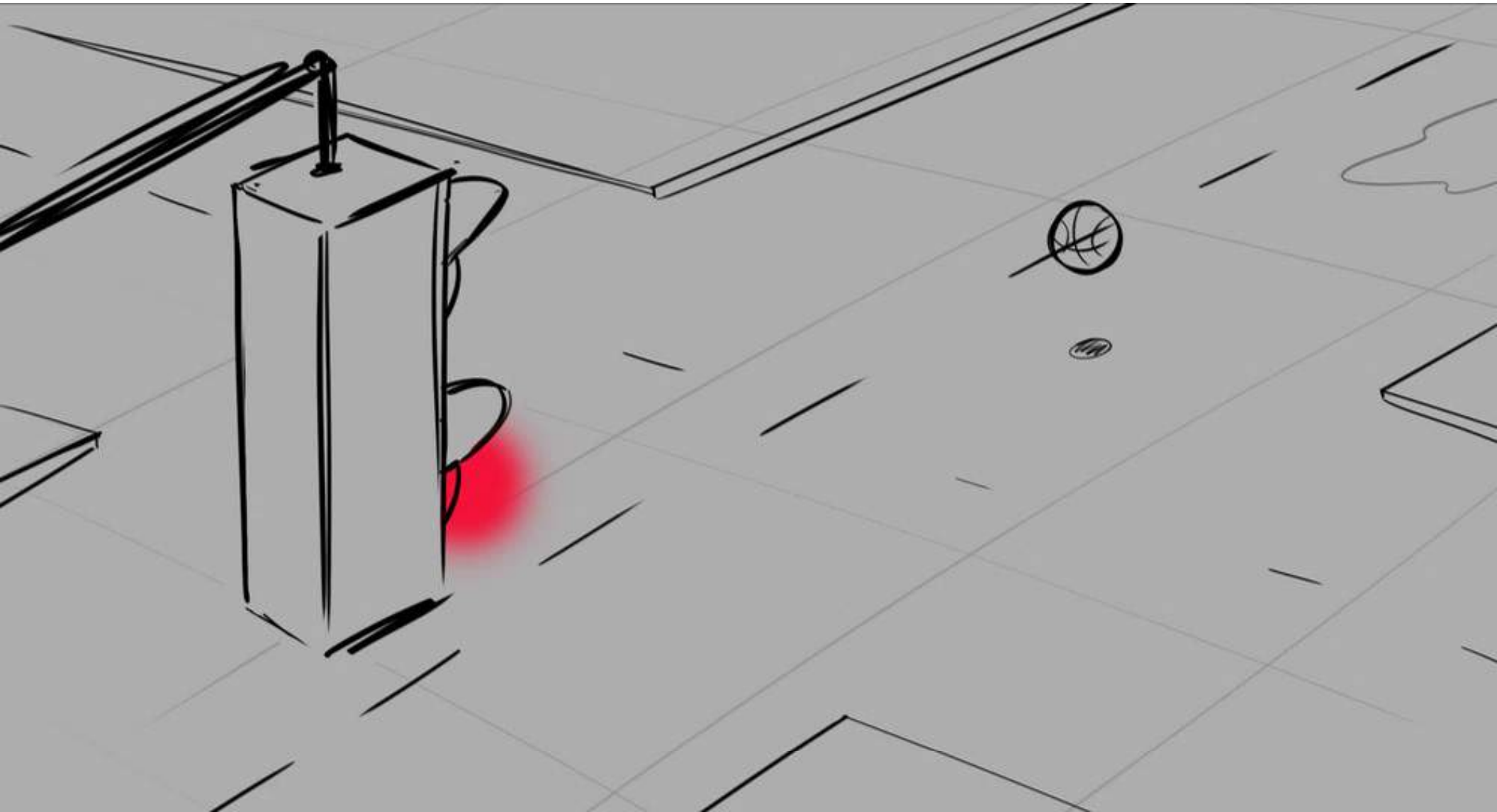

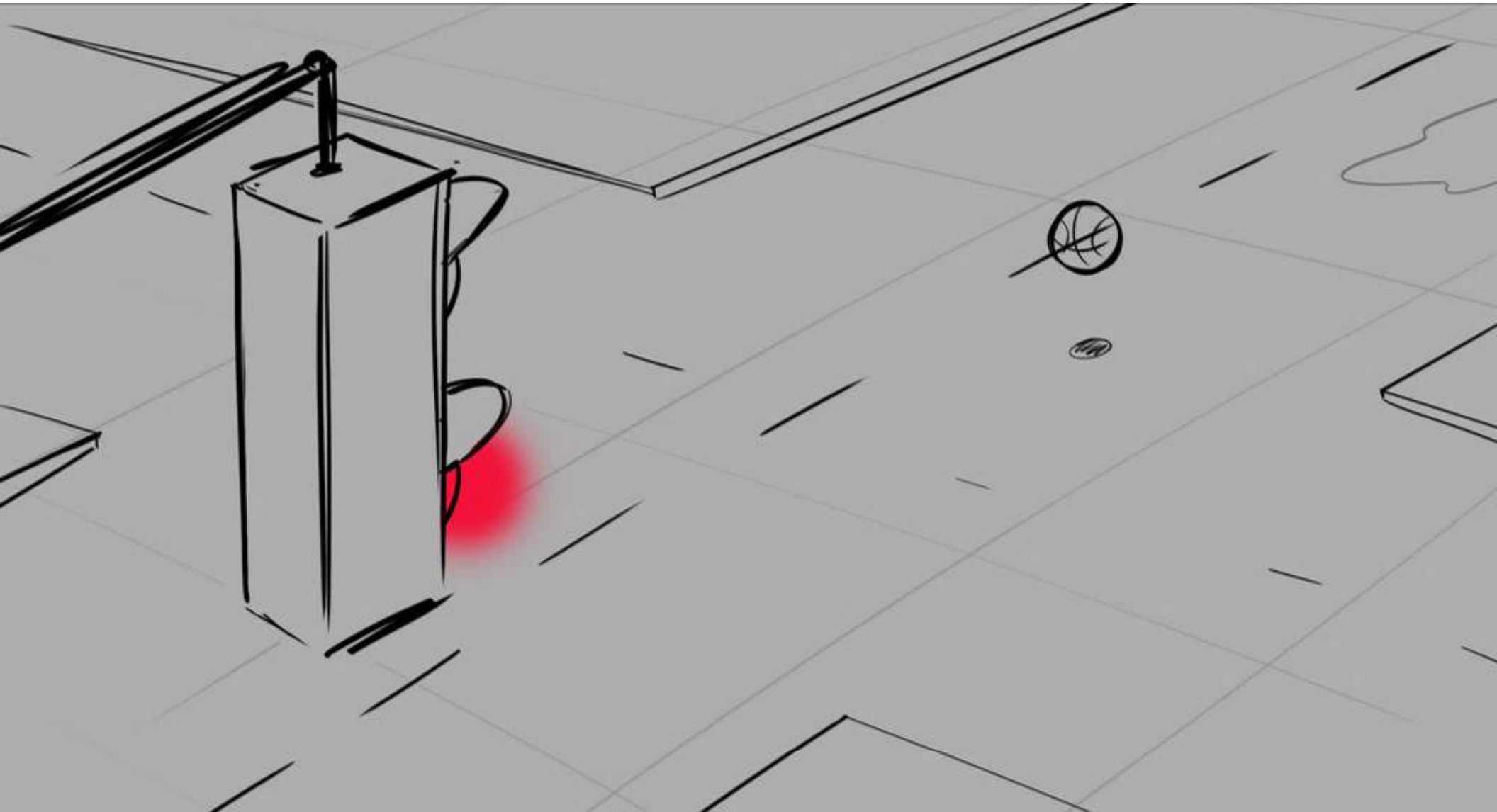

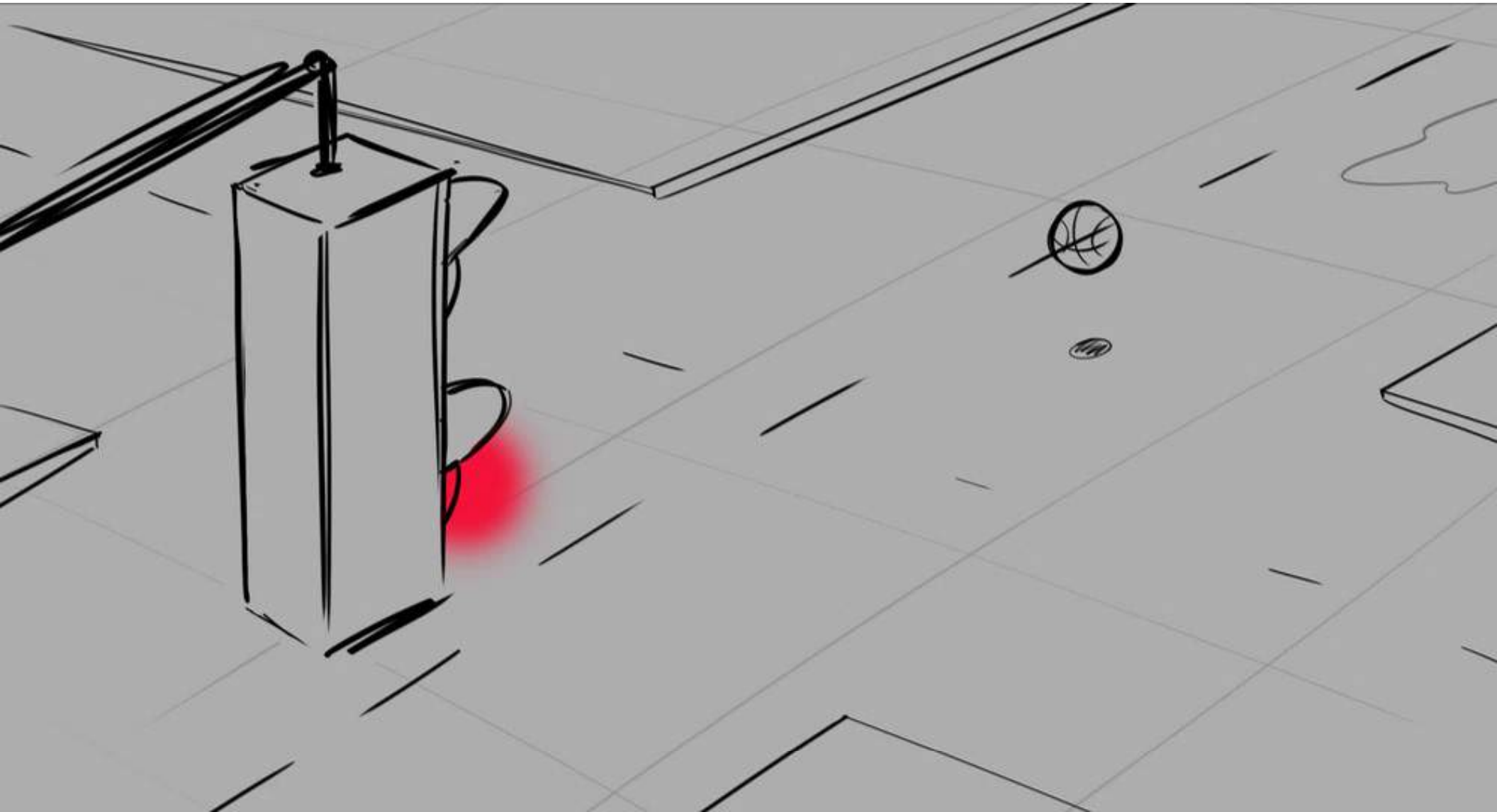

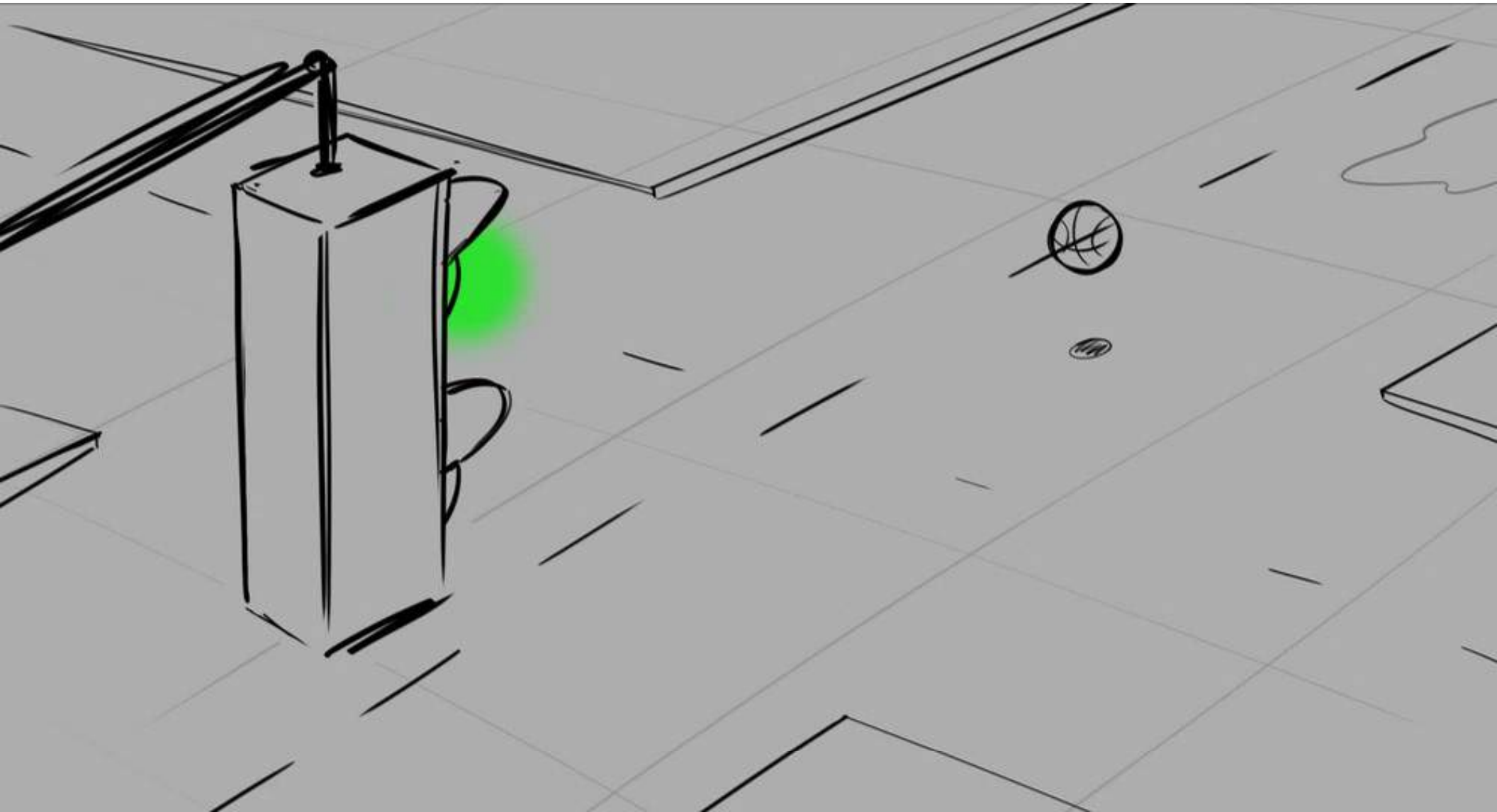

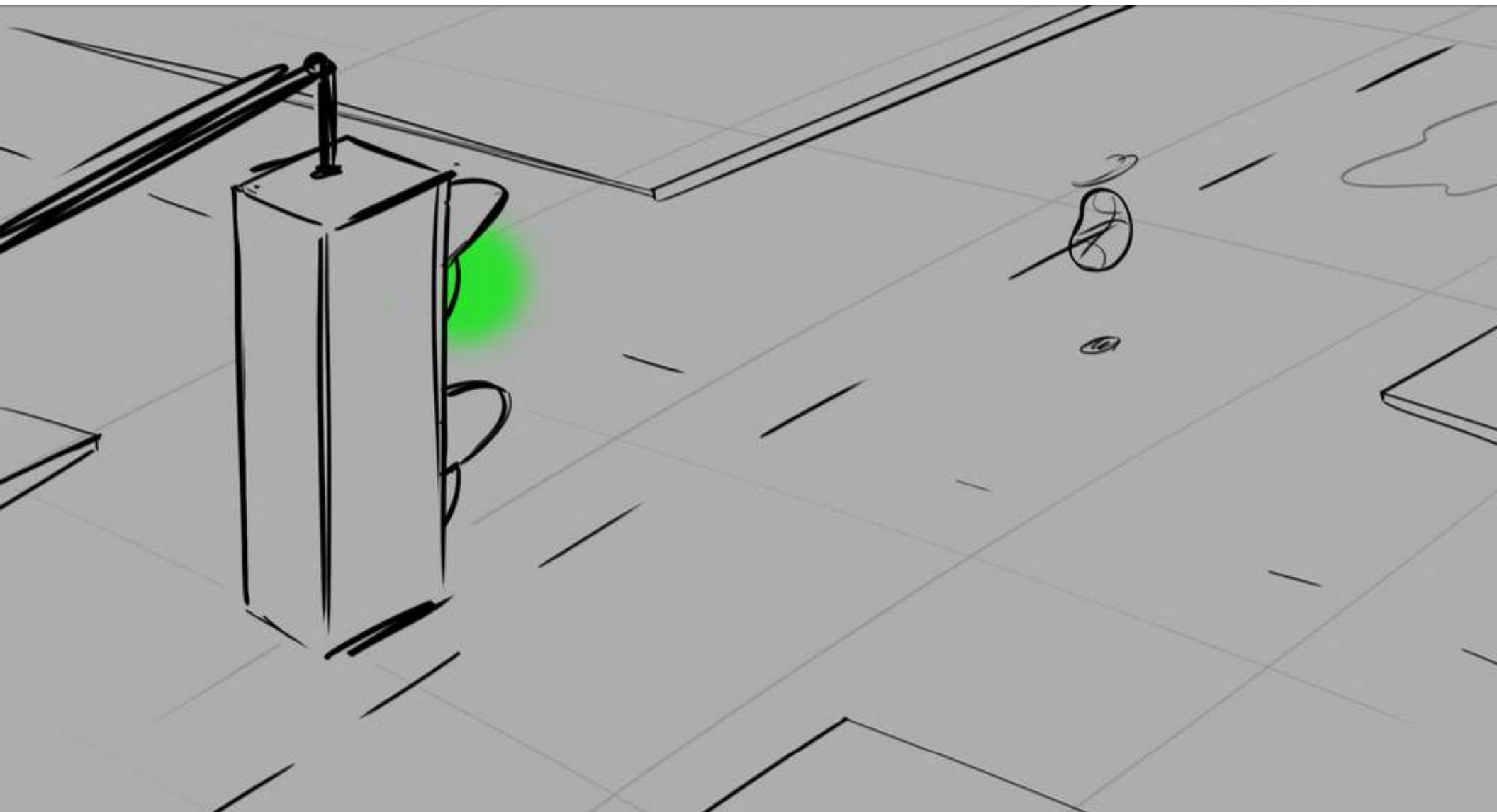

SFX: engine vroom

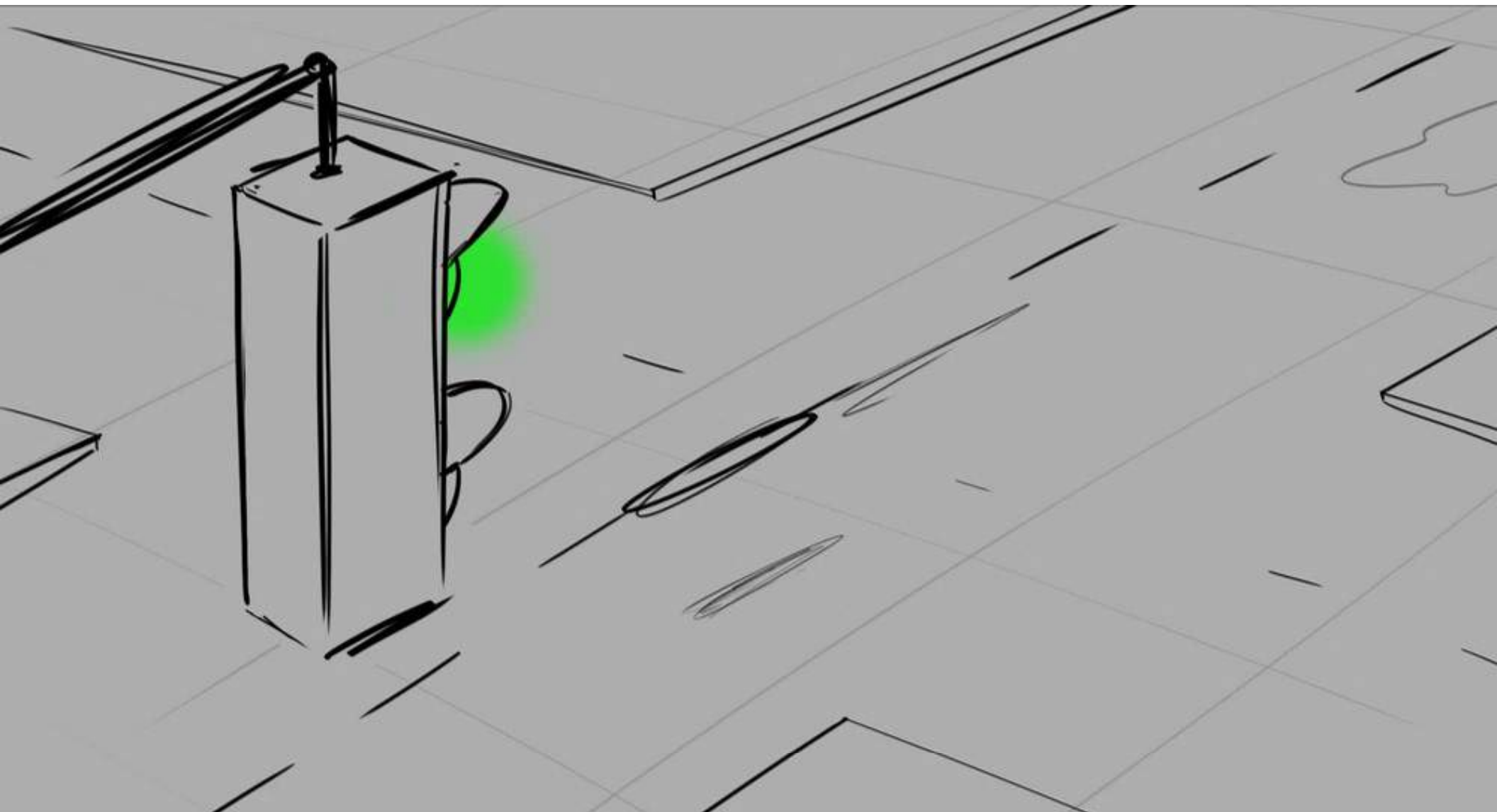

SFX: engine vroom

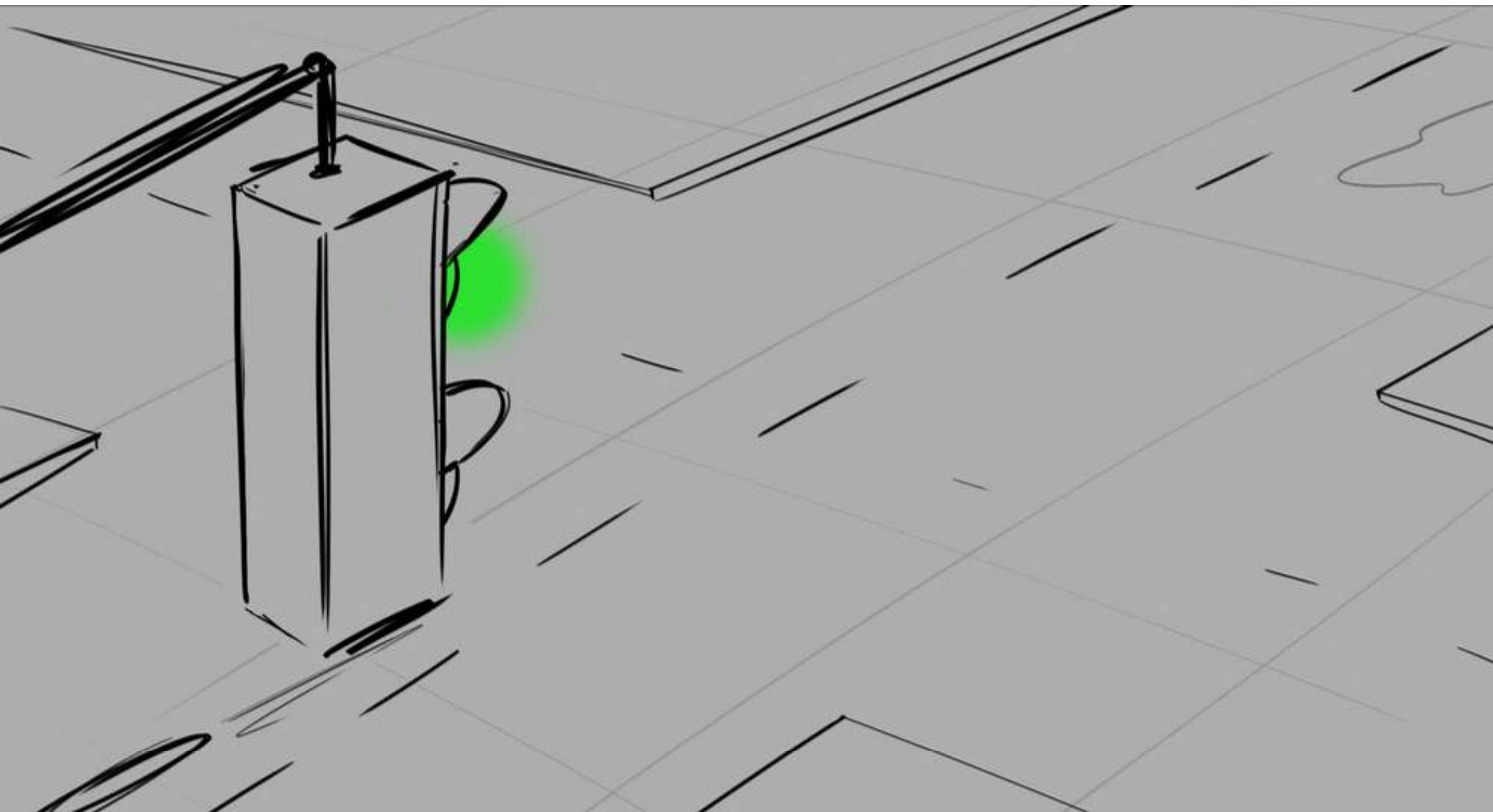

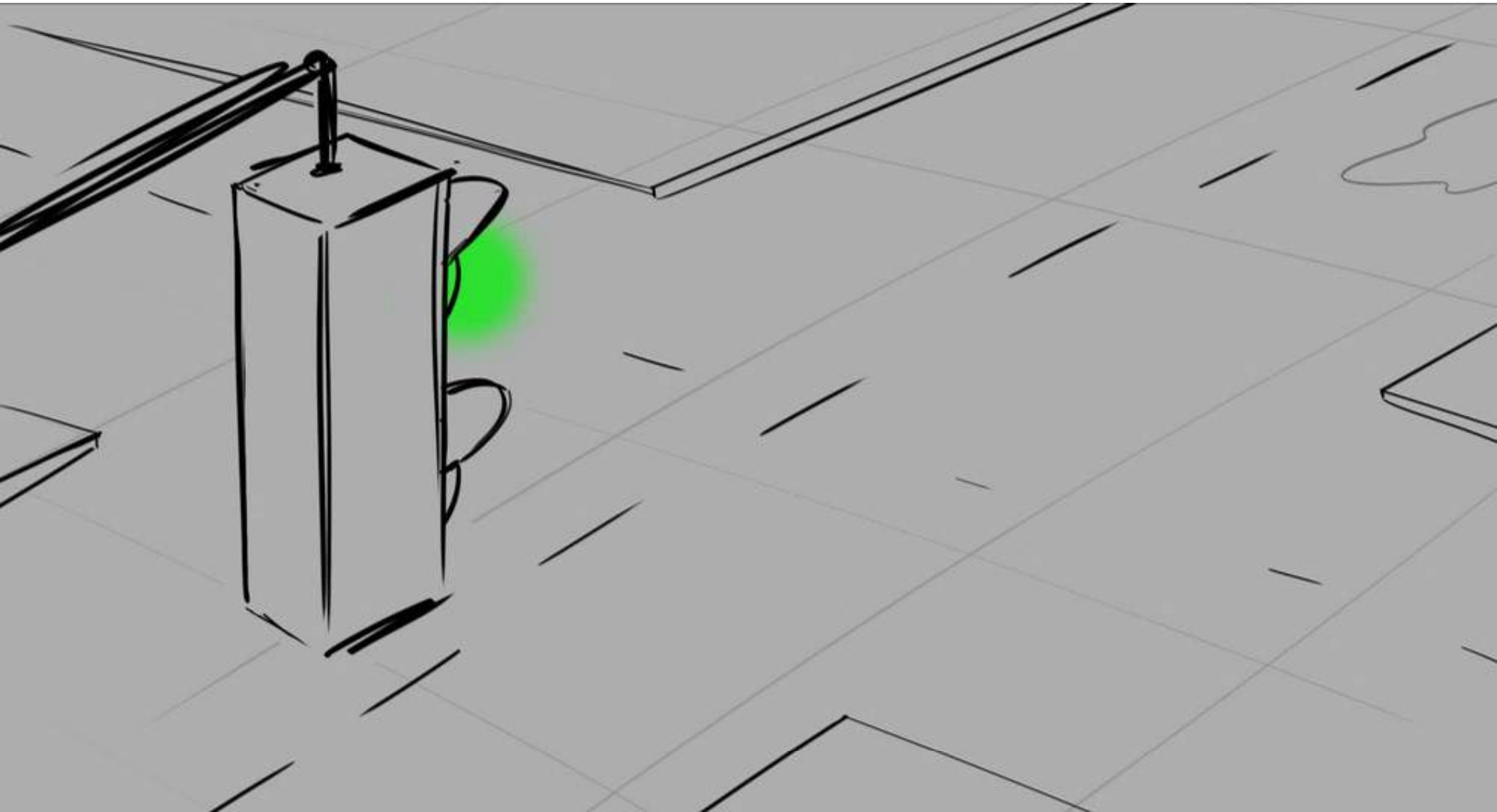

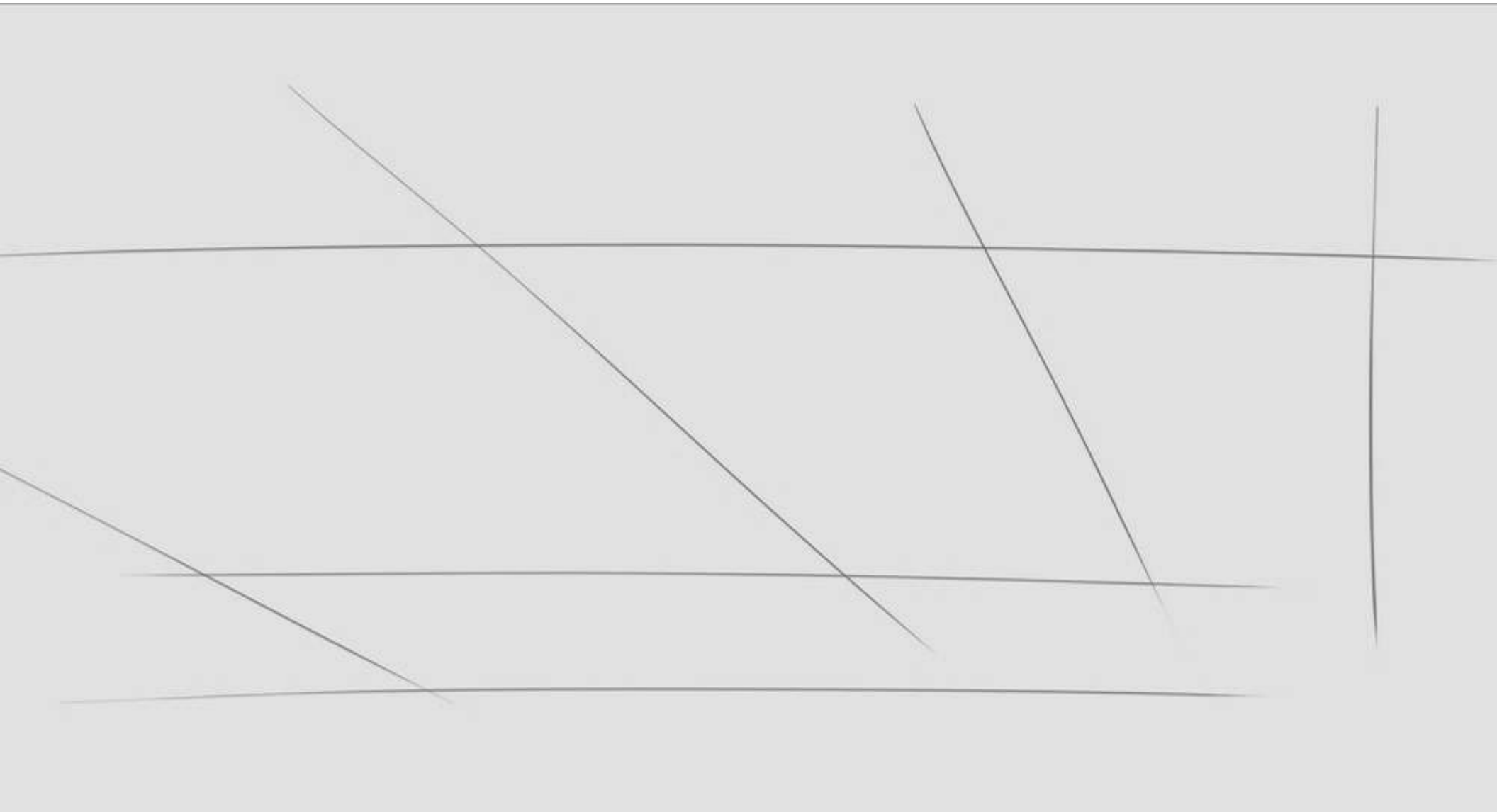

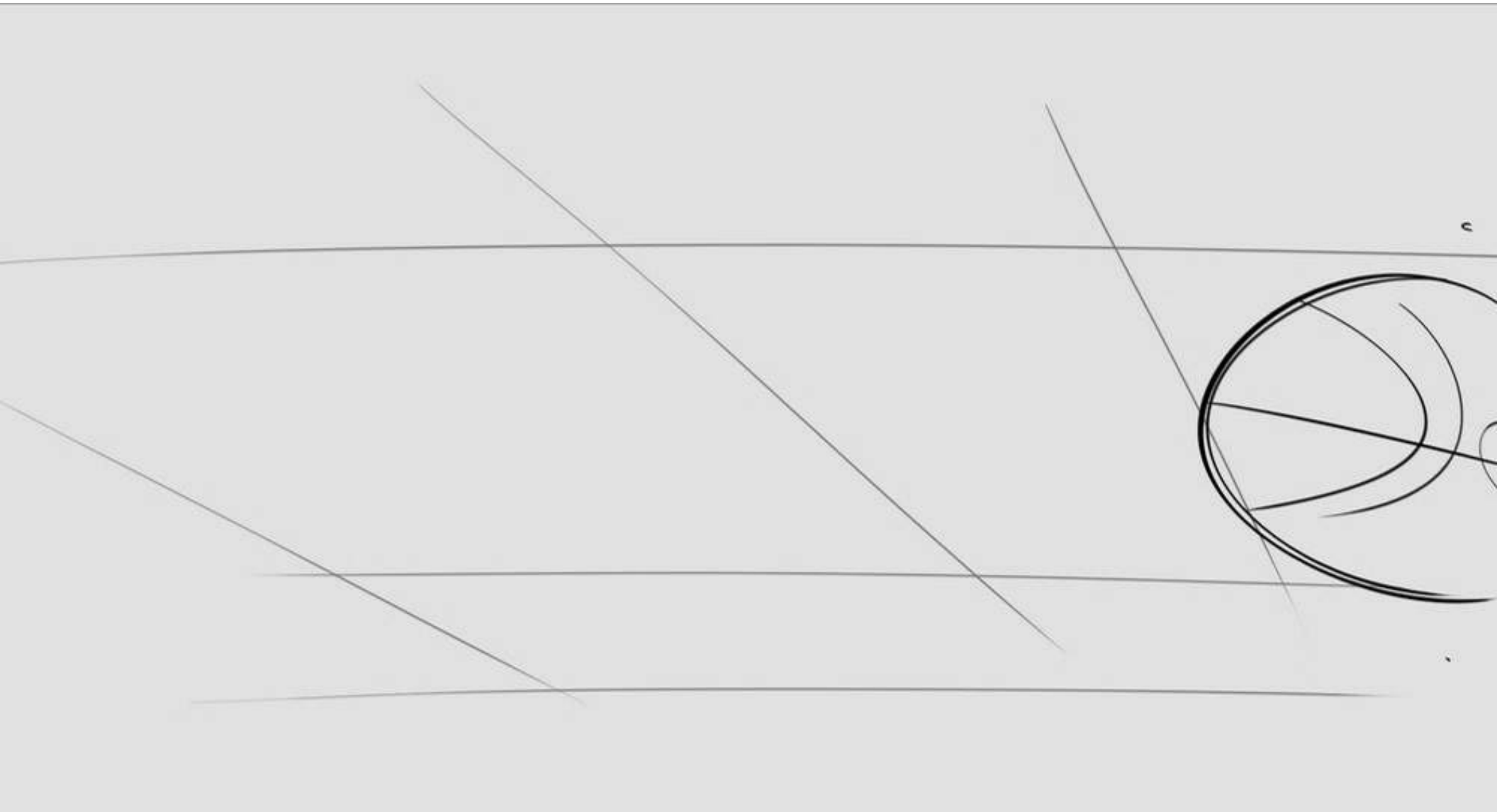

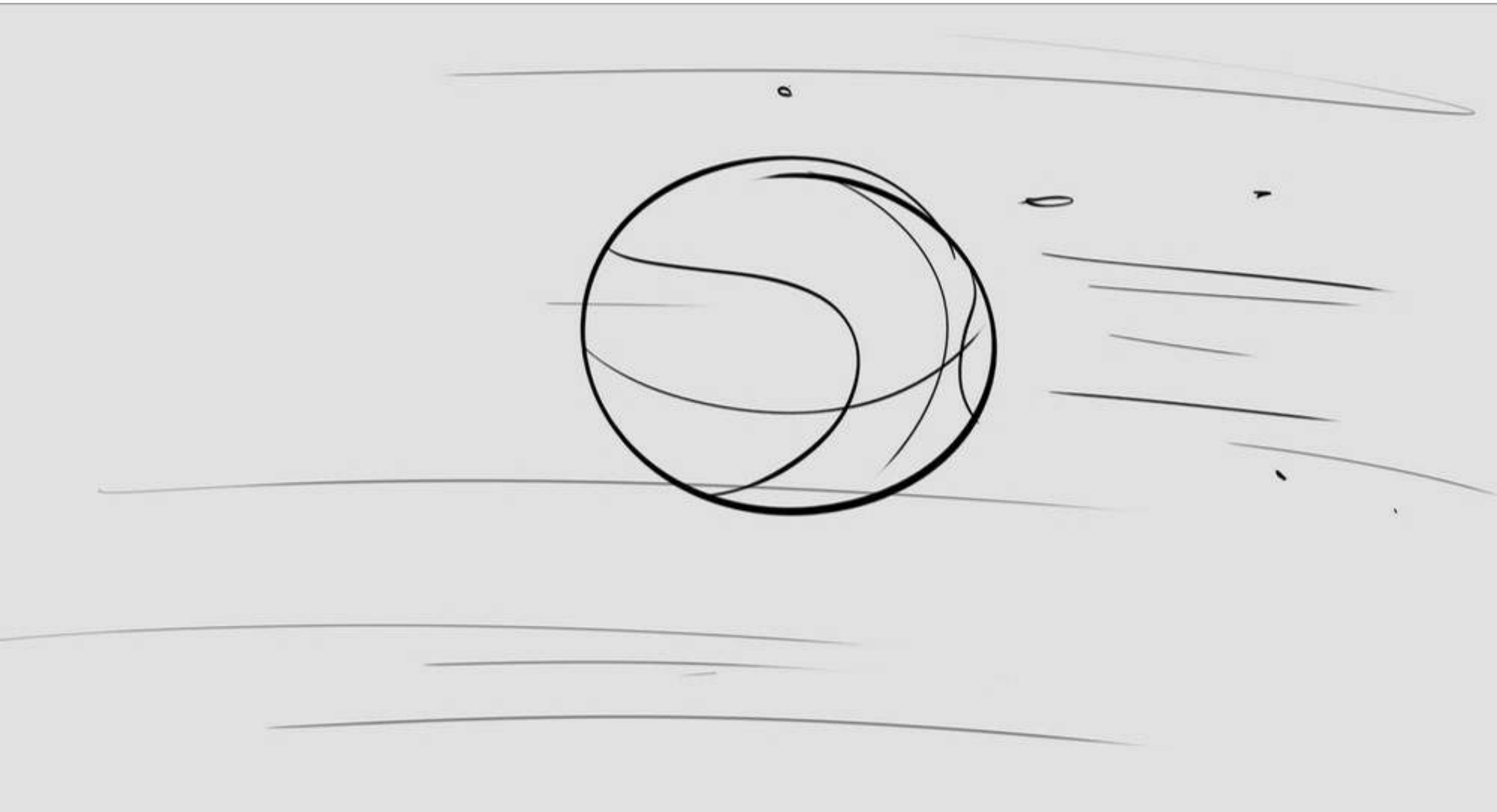

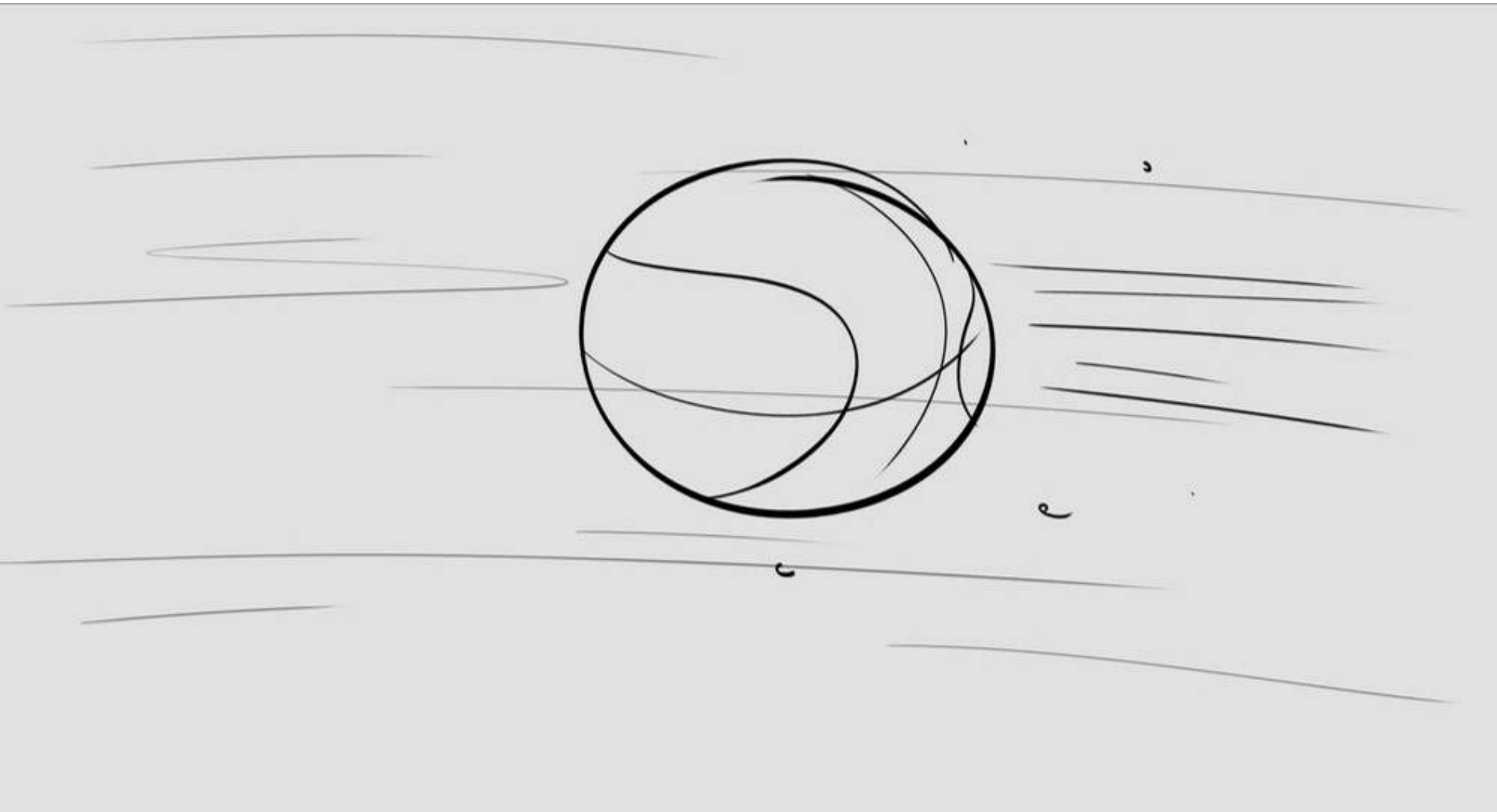

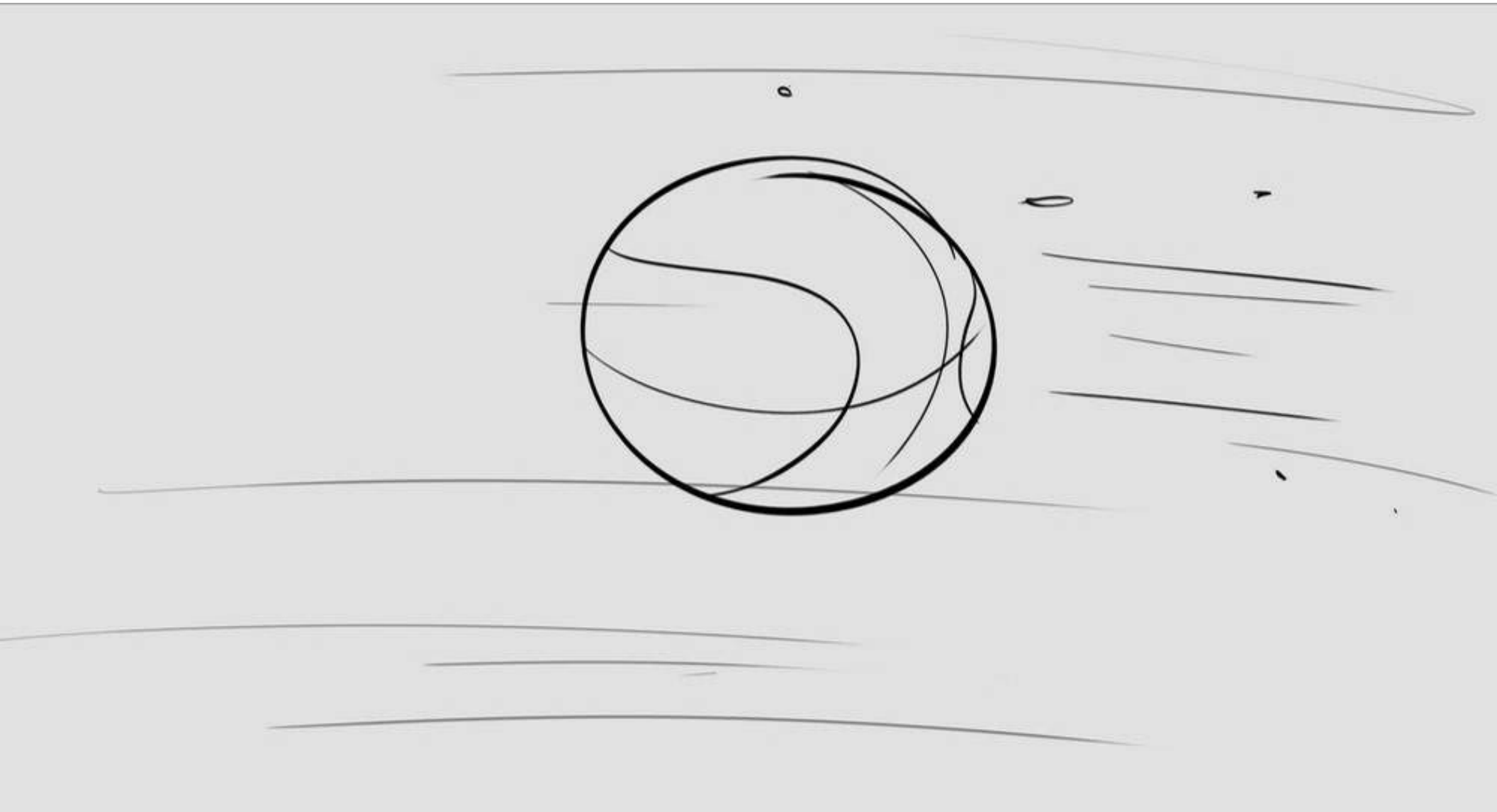

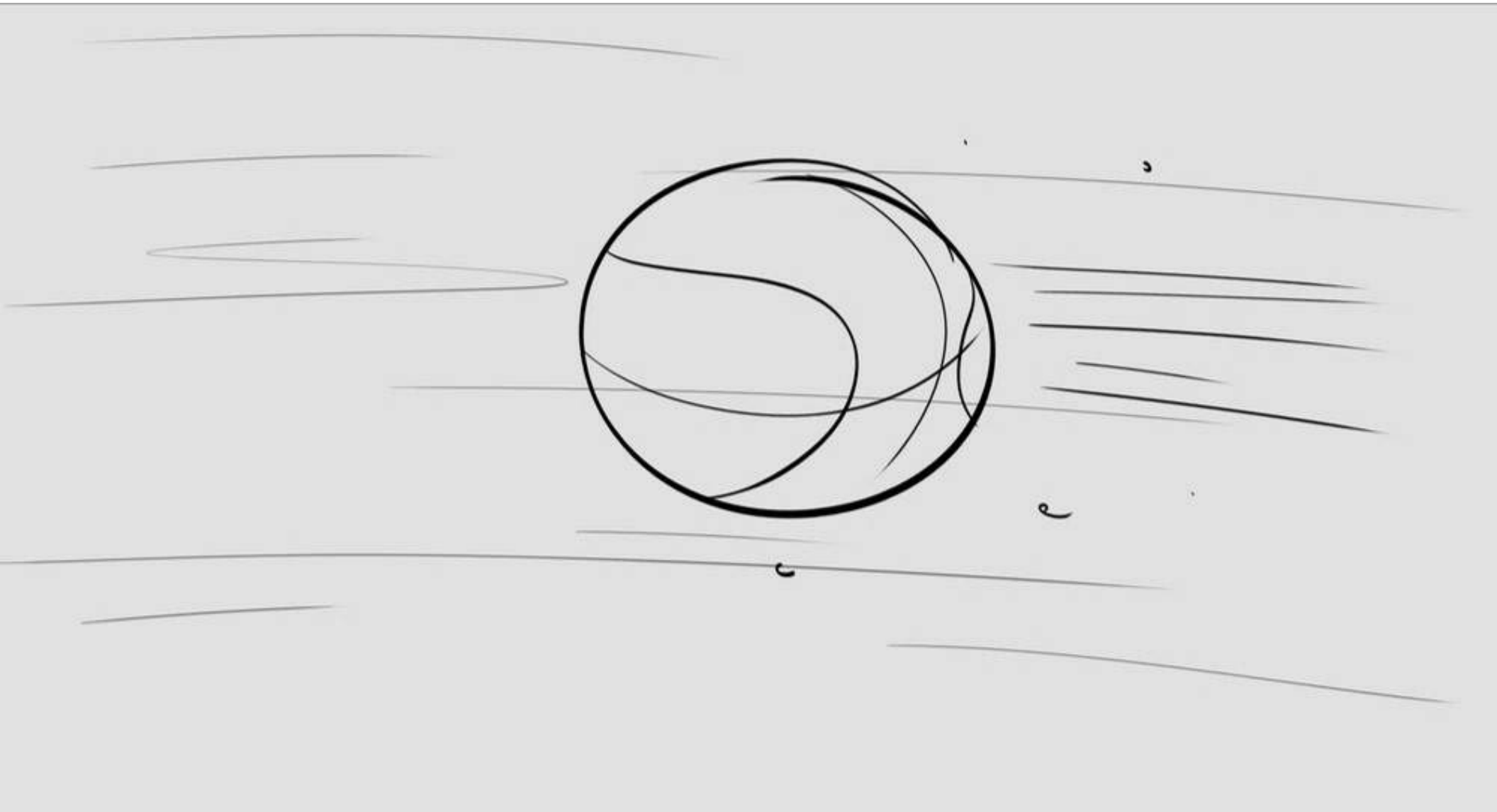

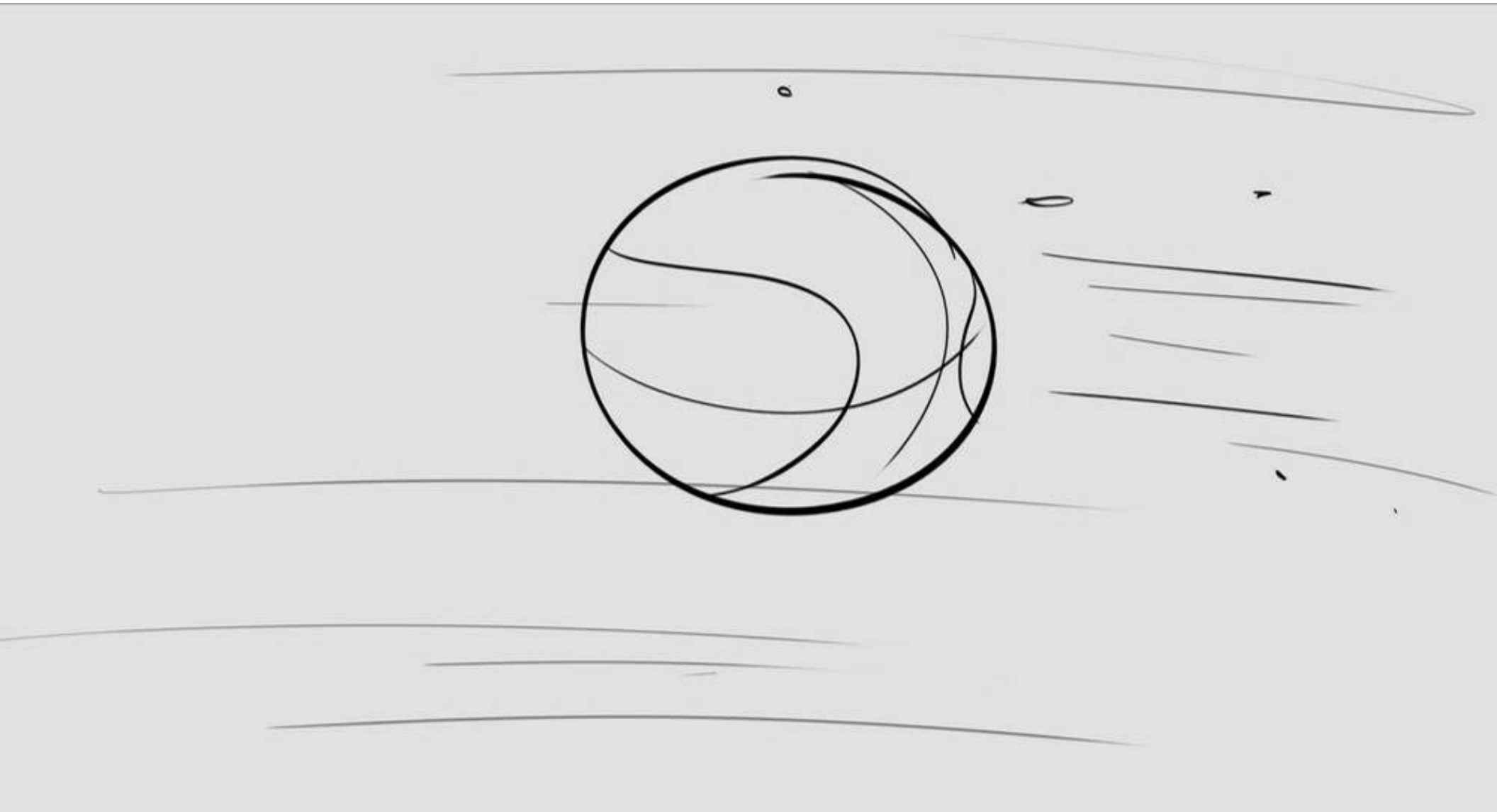

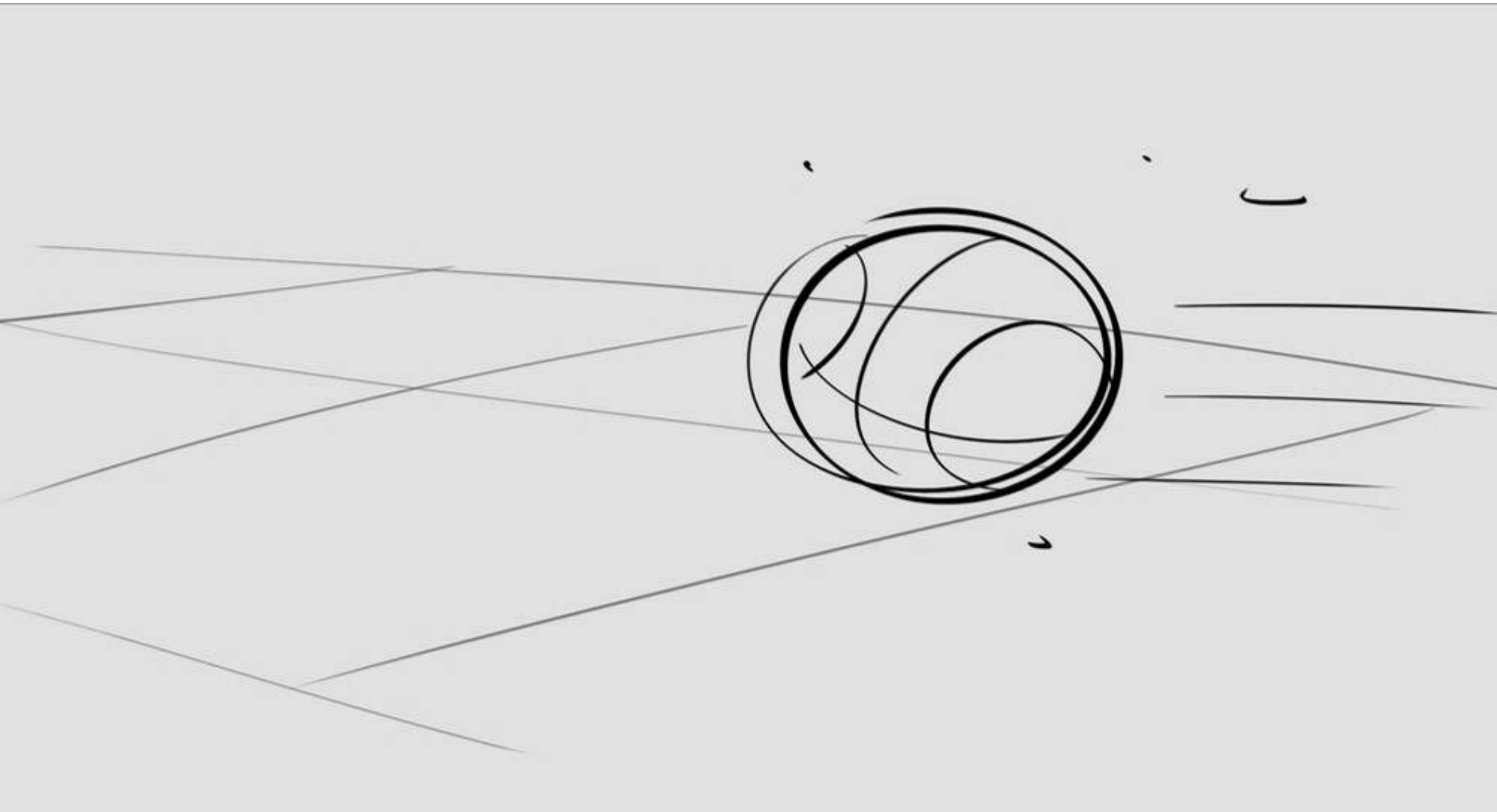

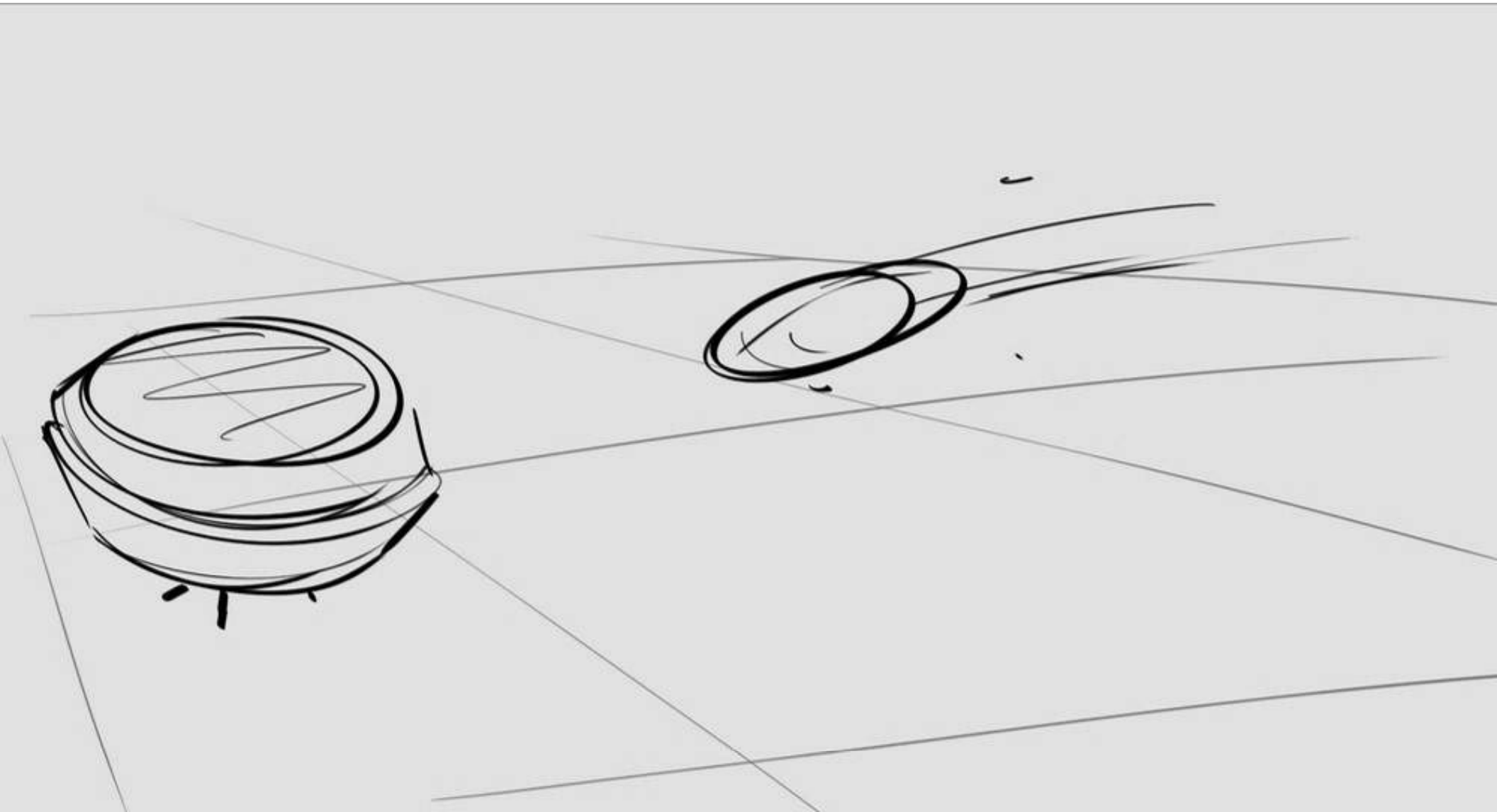

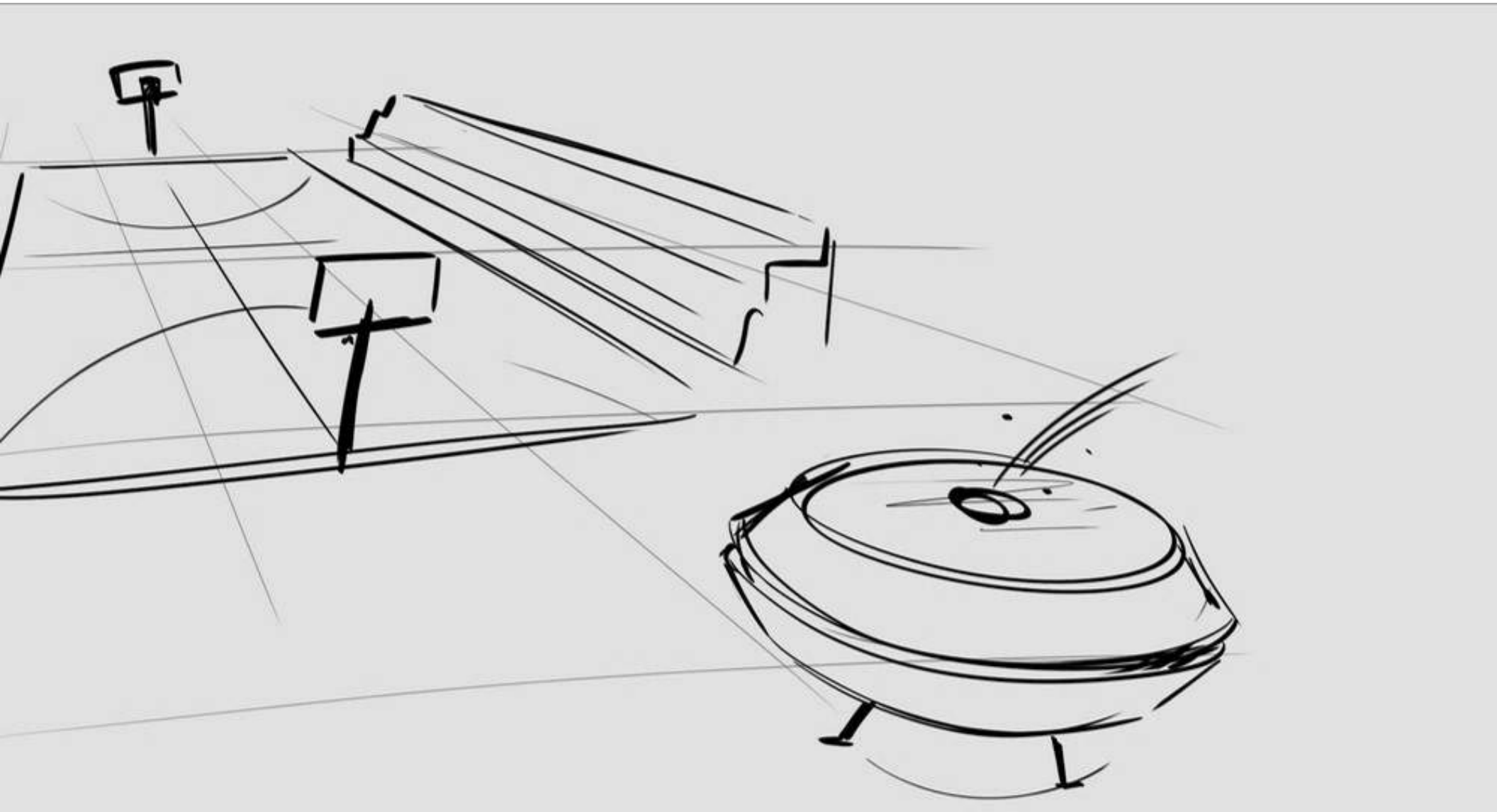

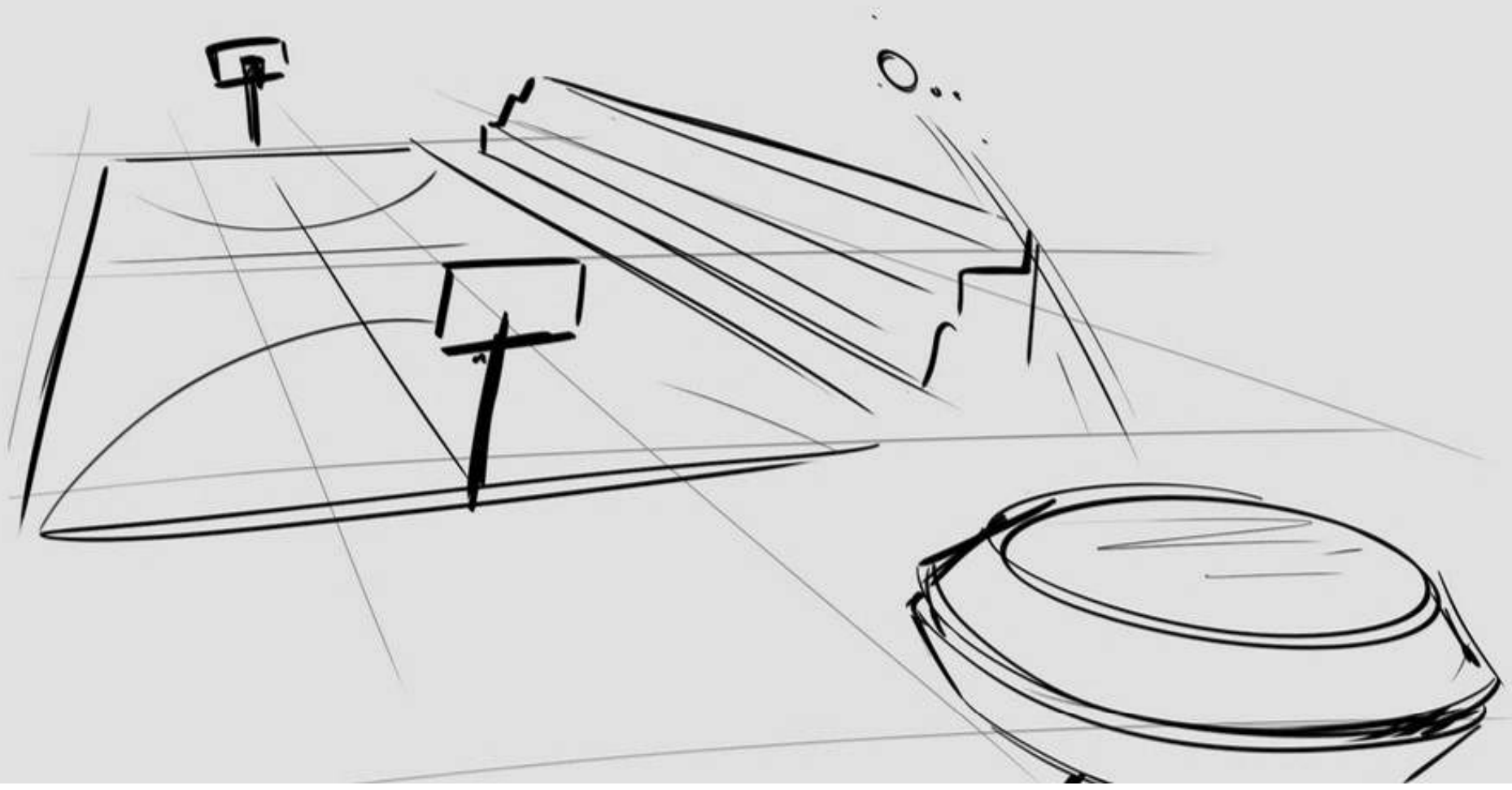

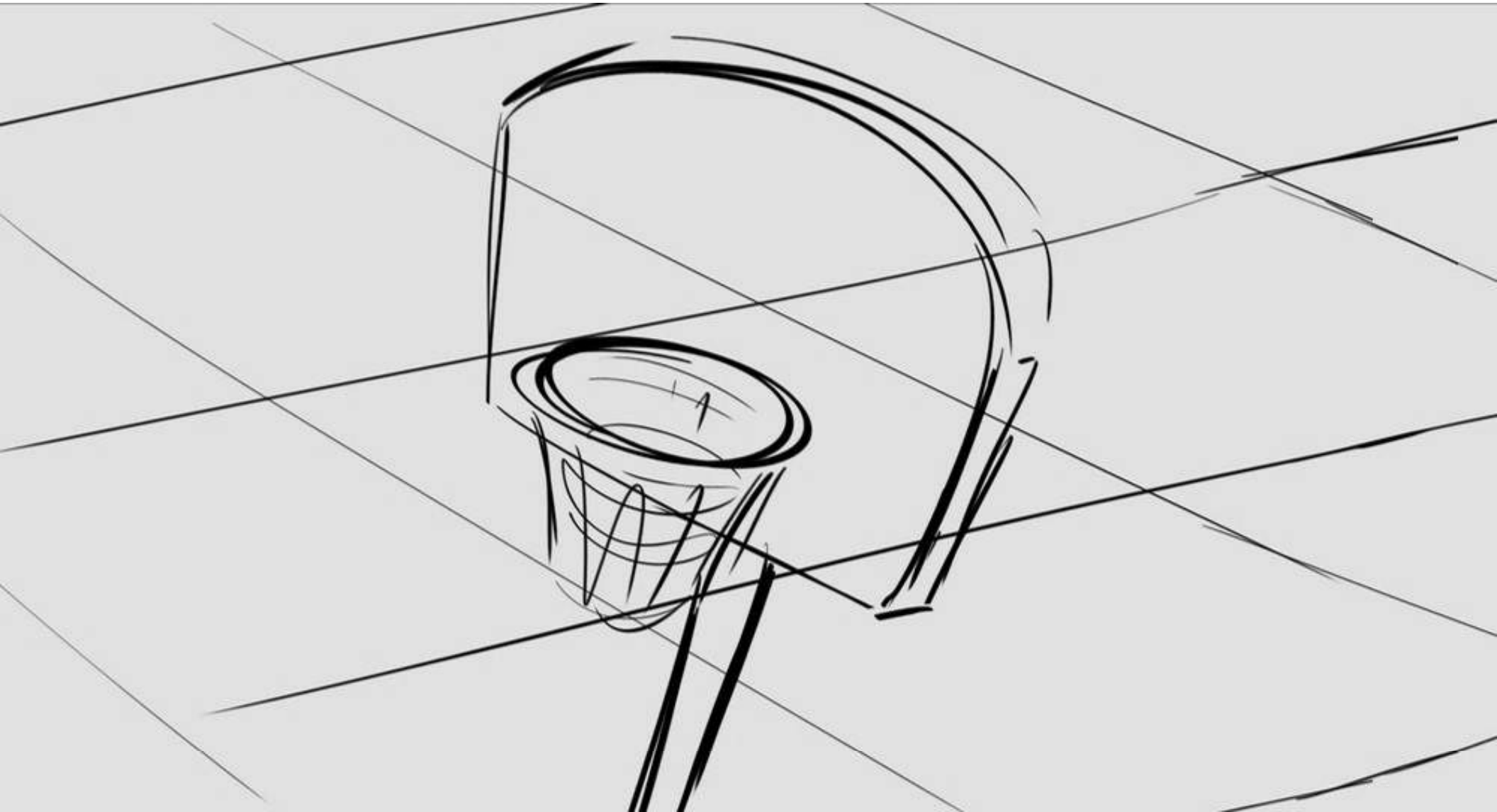

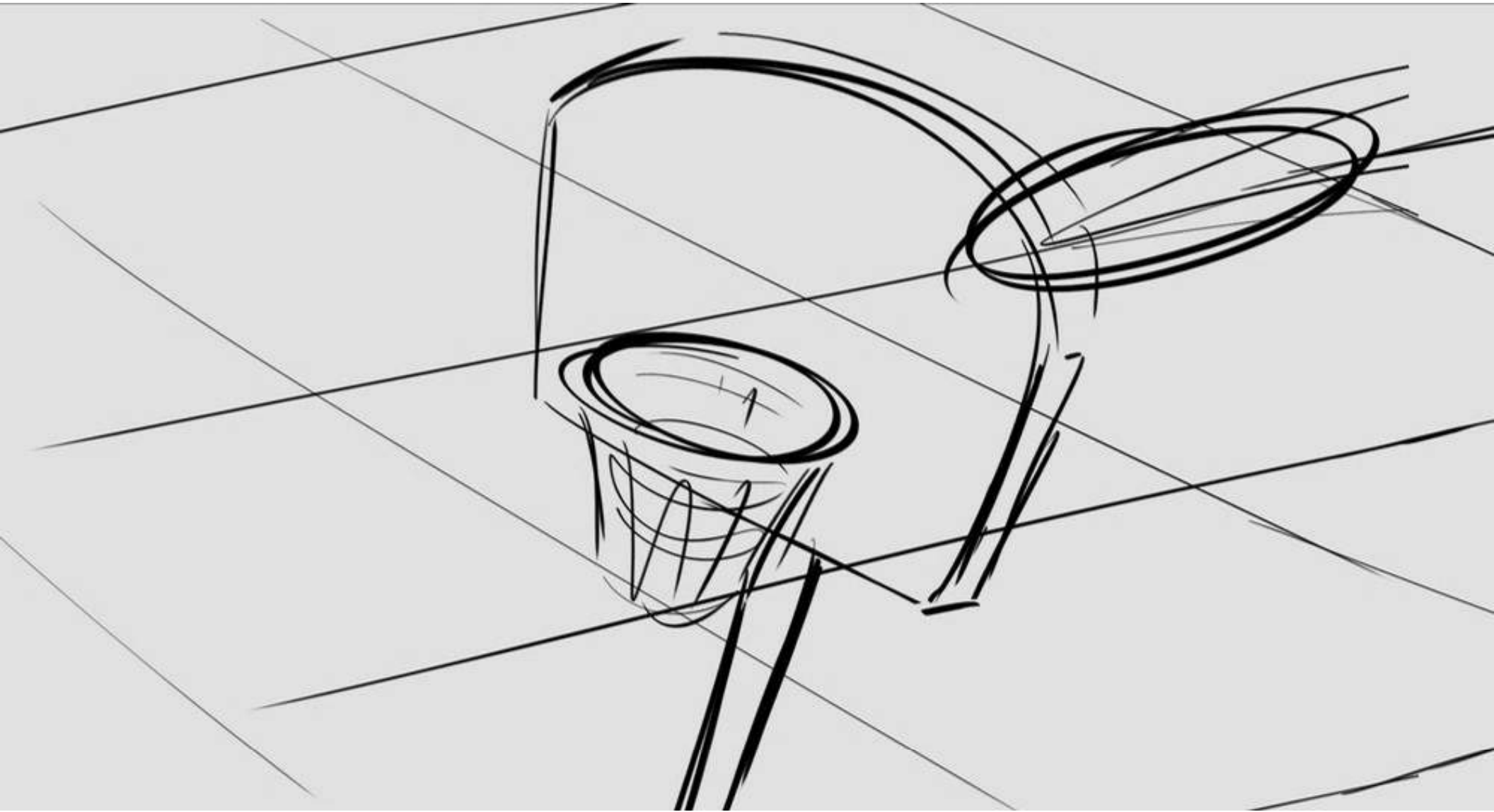

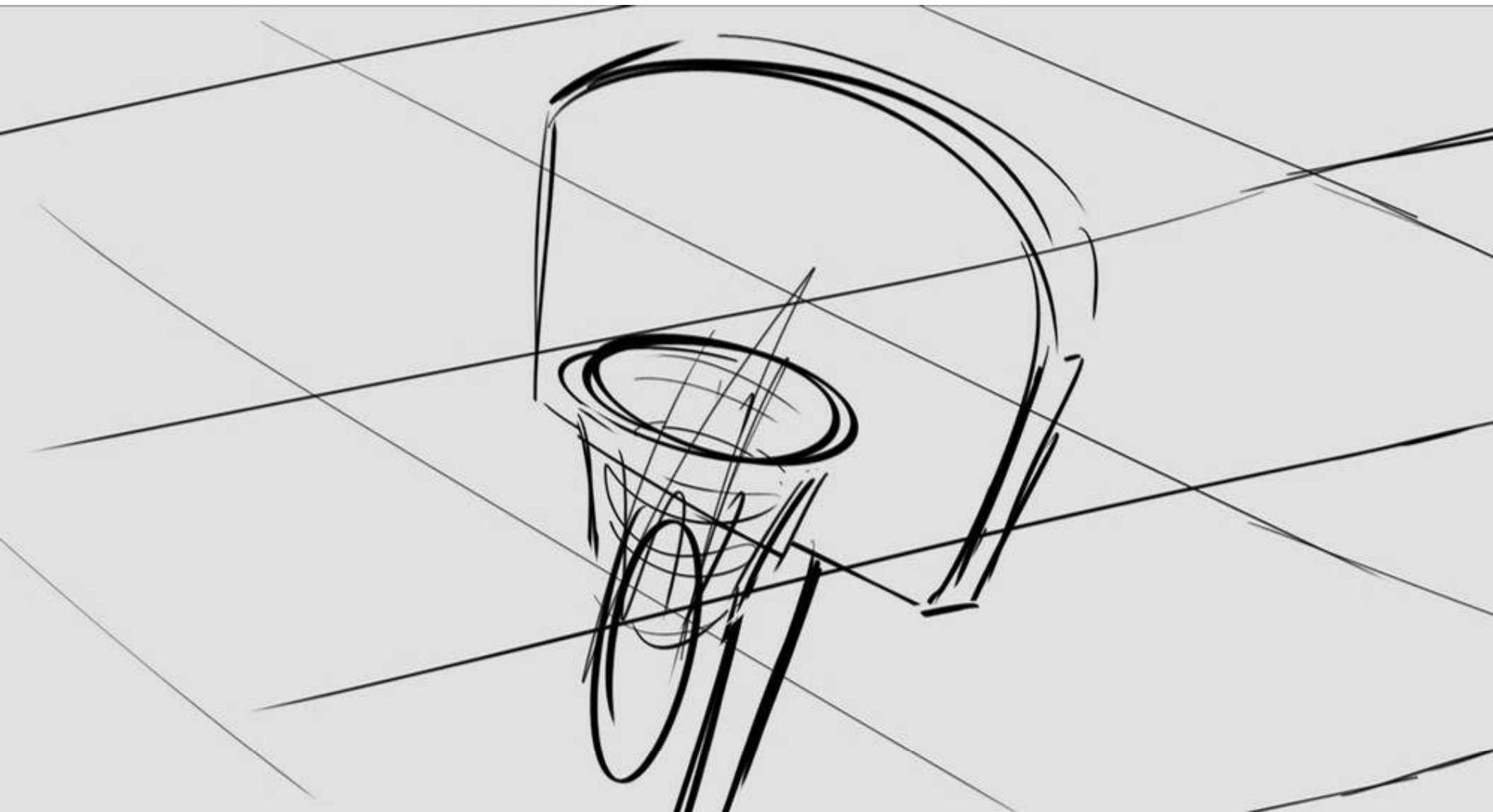

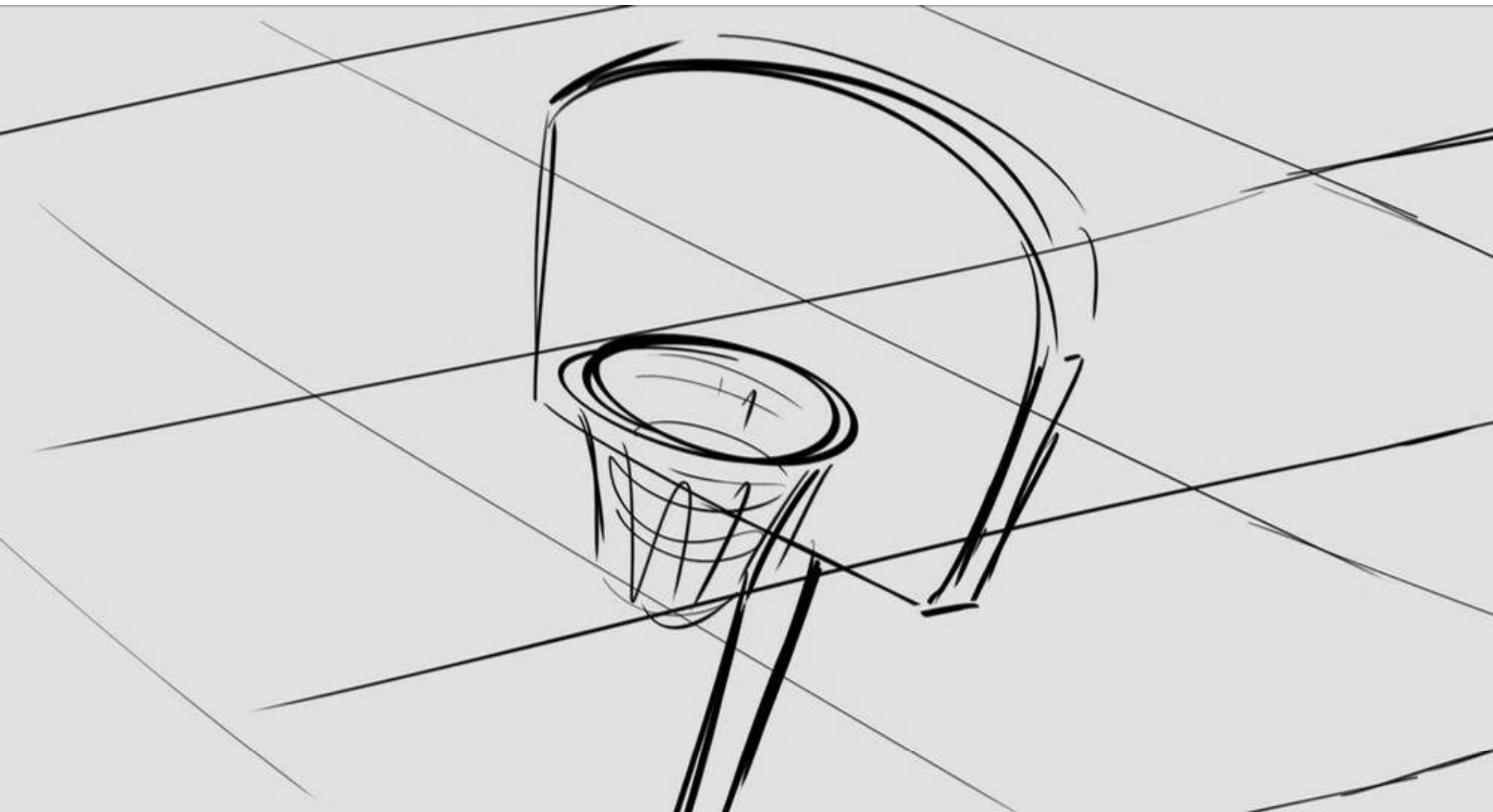

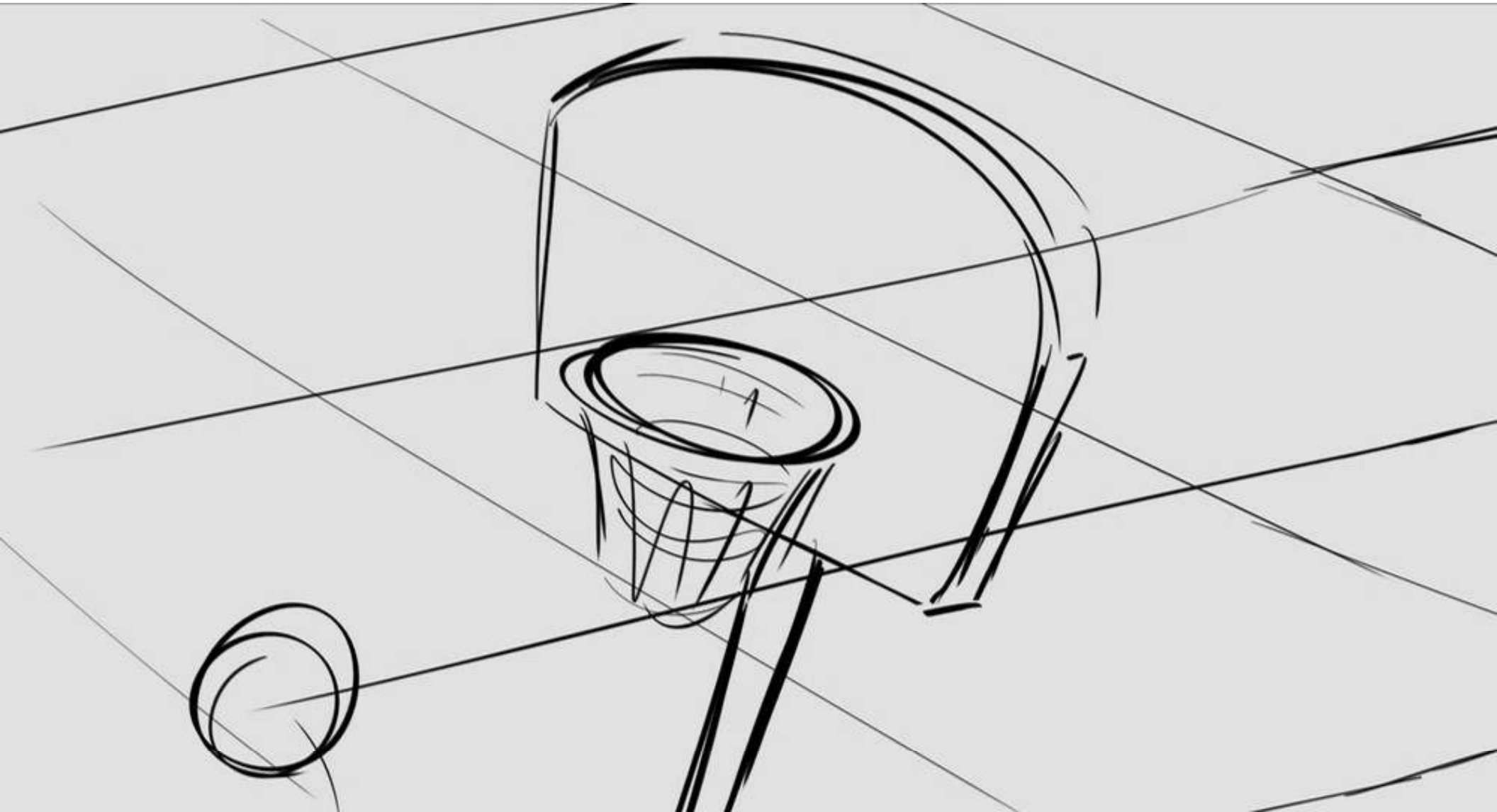

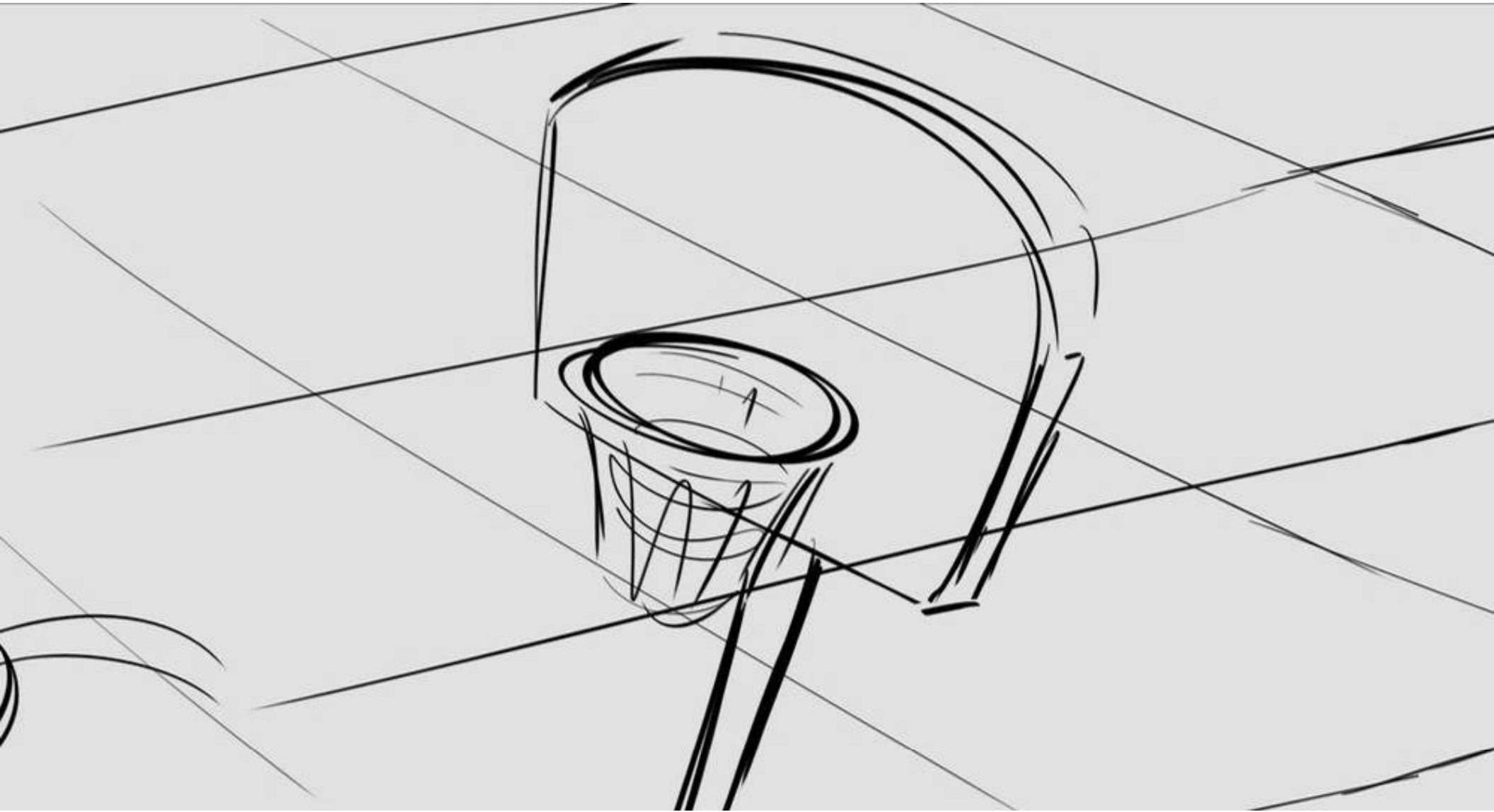

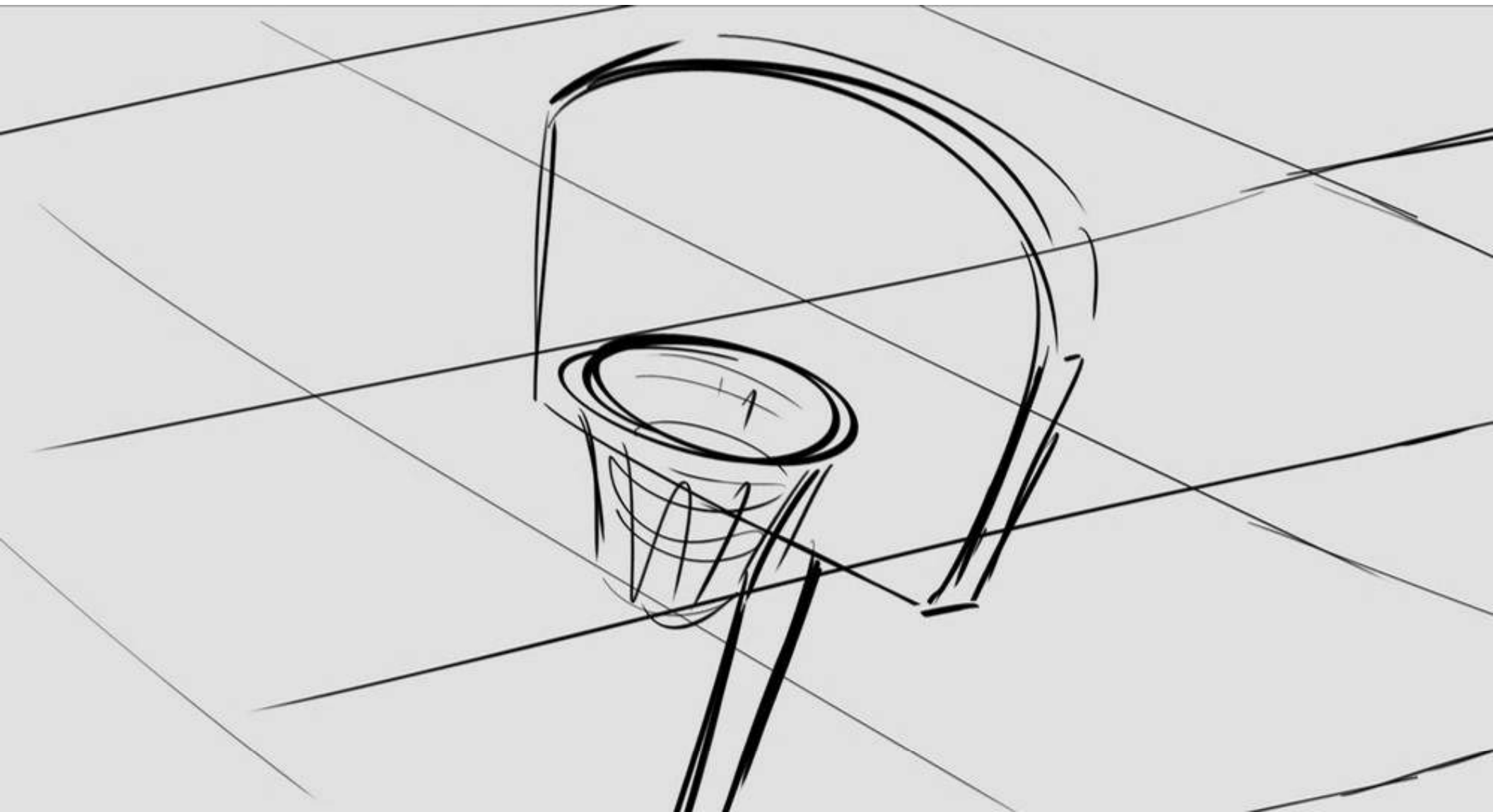

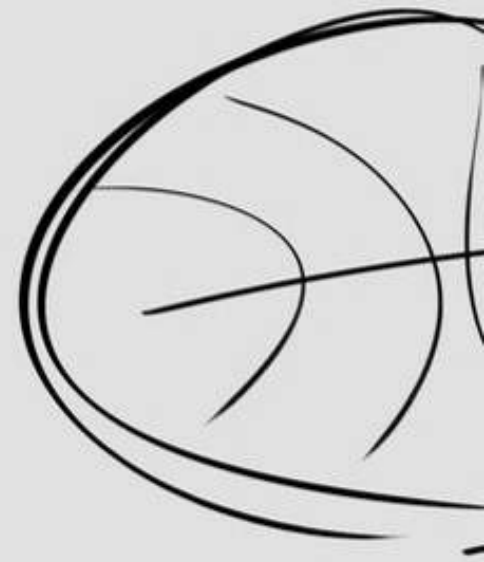

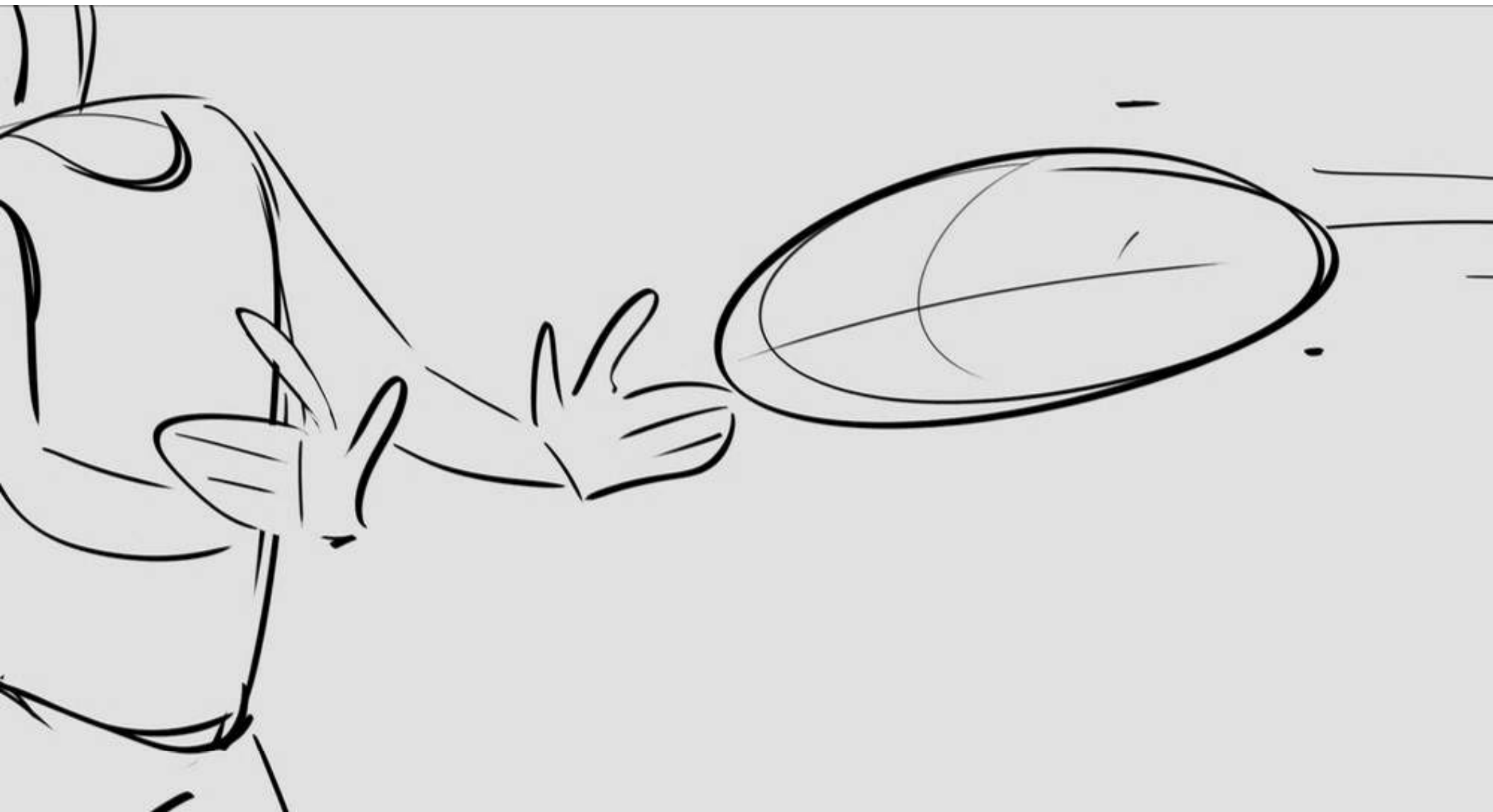

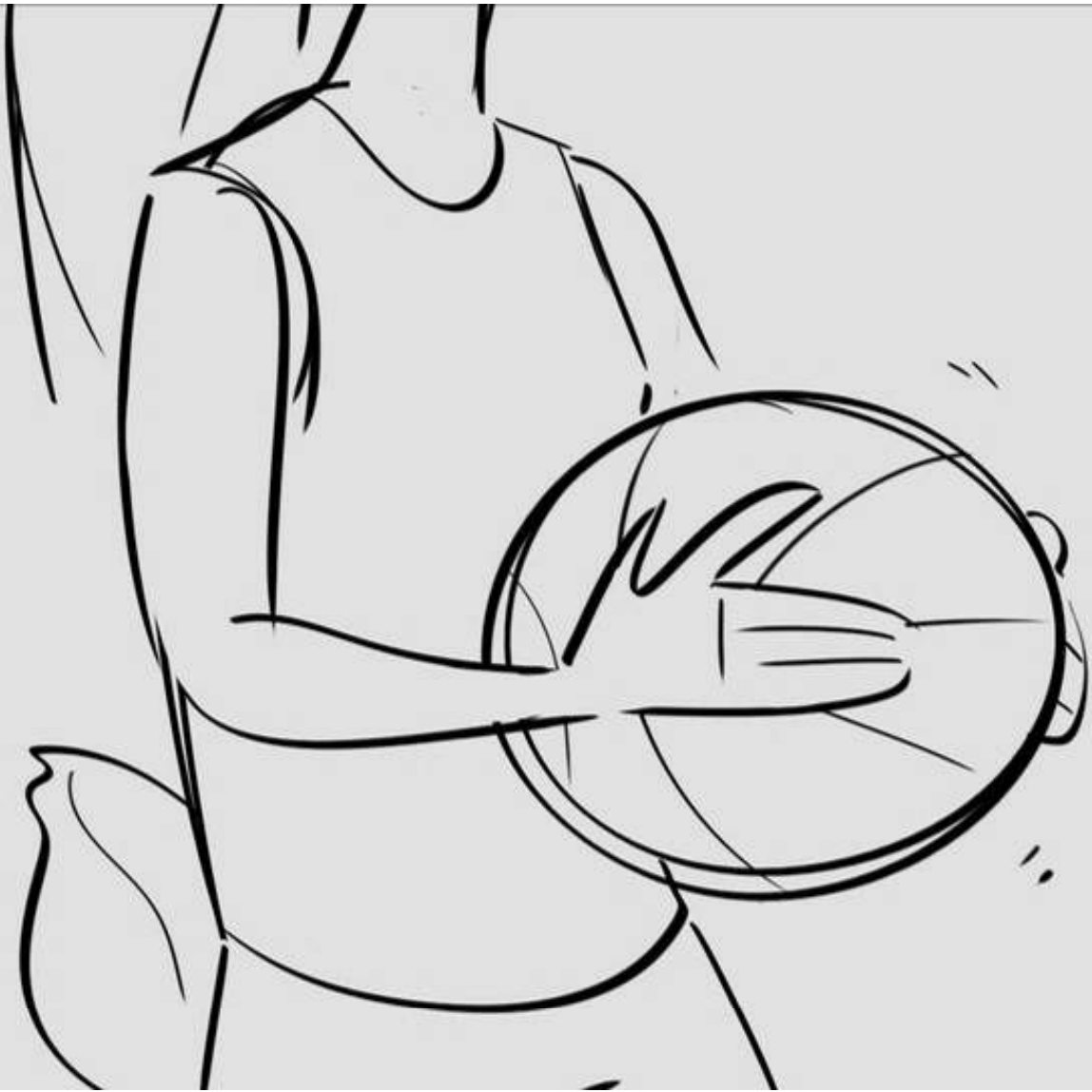





LOLA: Bugs is my friend, don't get me wrong.



LOLA: But the Amazons are my new team.



LOLA: But the Amazons are my new team.



LOLA: I'm doing this because it's the Amazon way.



LOLA: I'm gonna fight for you.

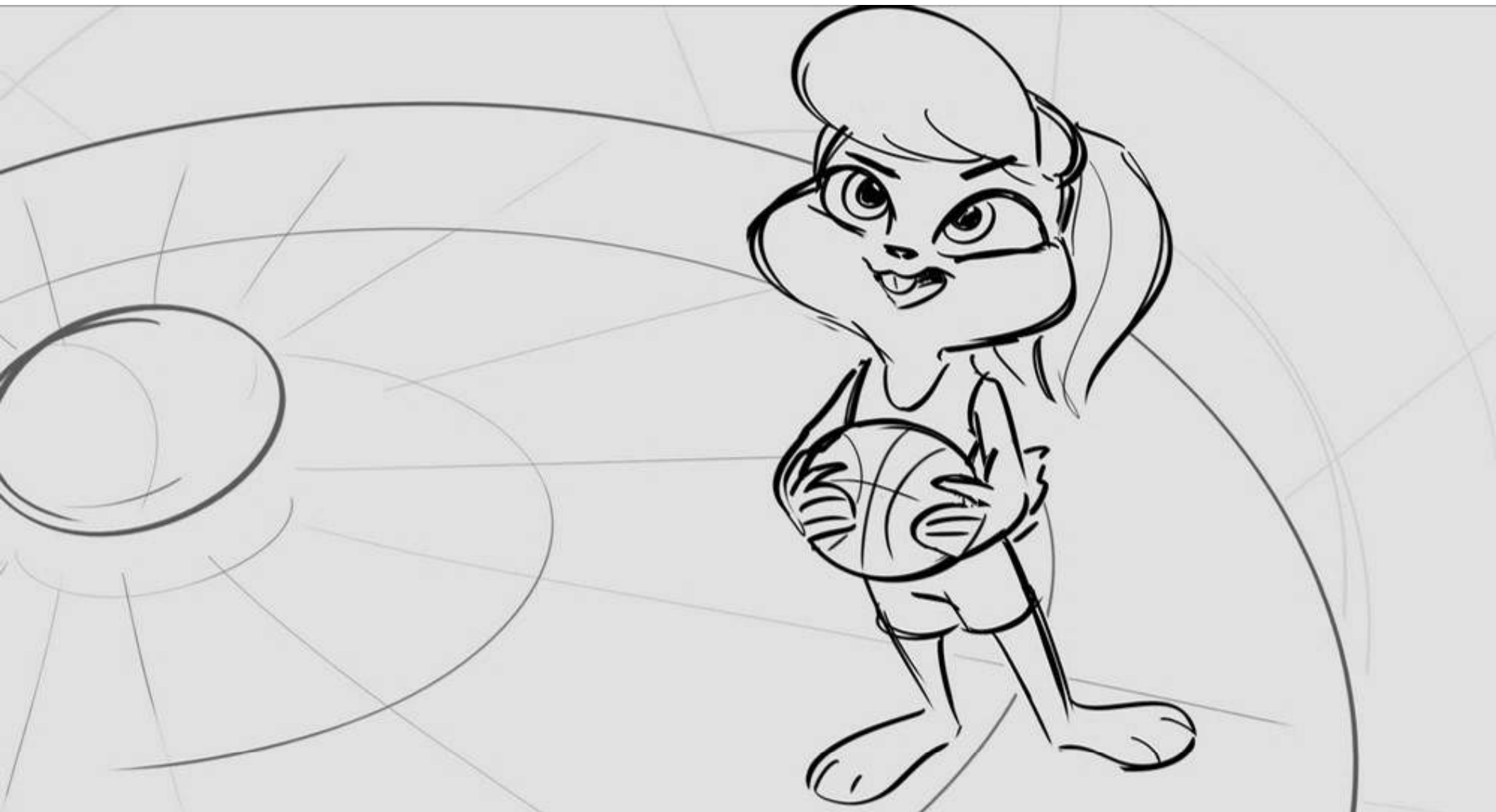

LOLA: But after...I'm going back.





LEBRON: You really dig those eight-foot-tall warrior women, huh.

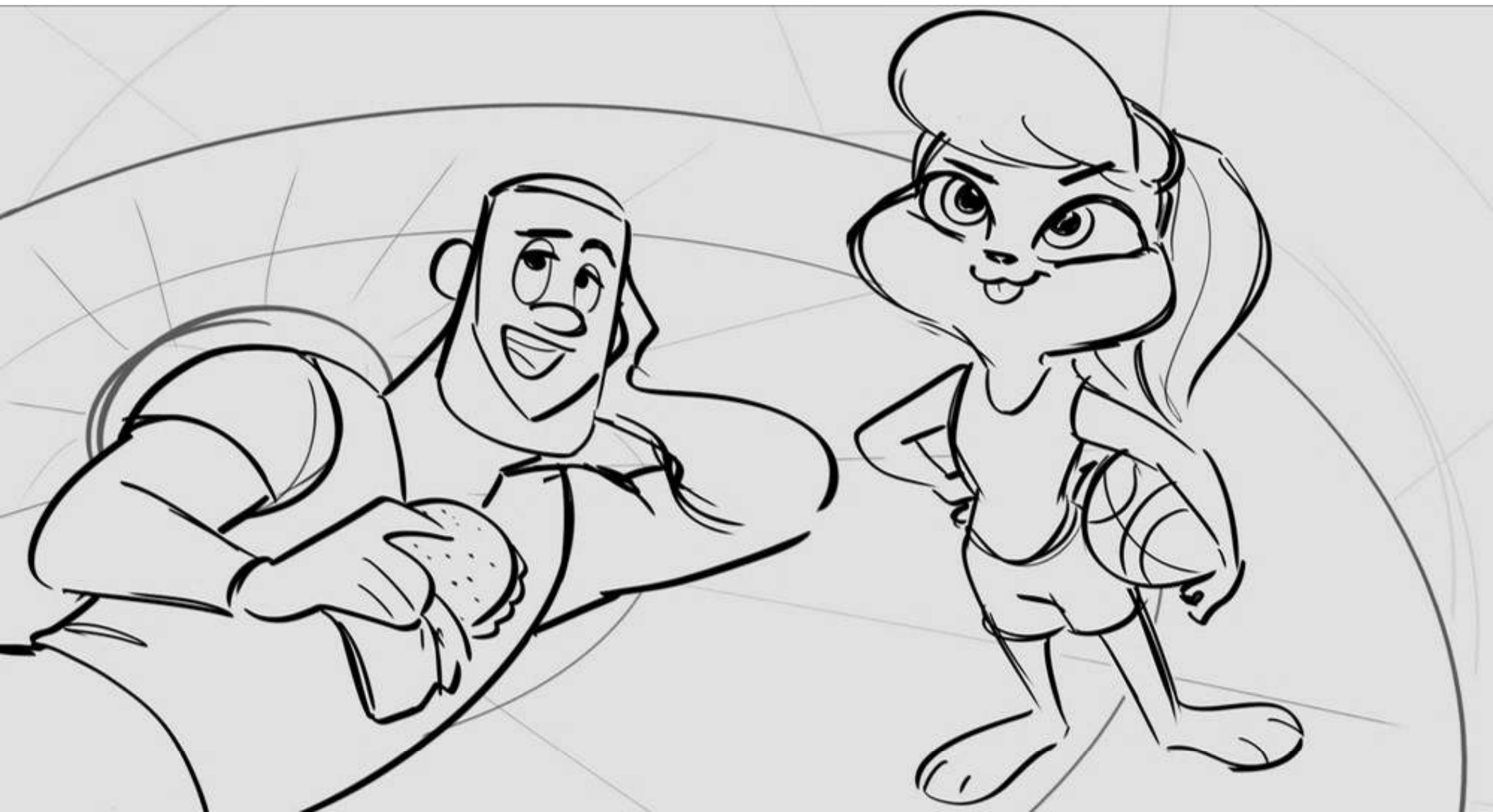

LEBRON: You really dig those eight-foot-tall warrior women, huh.

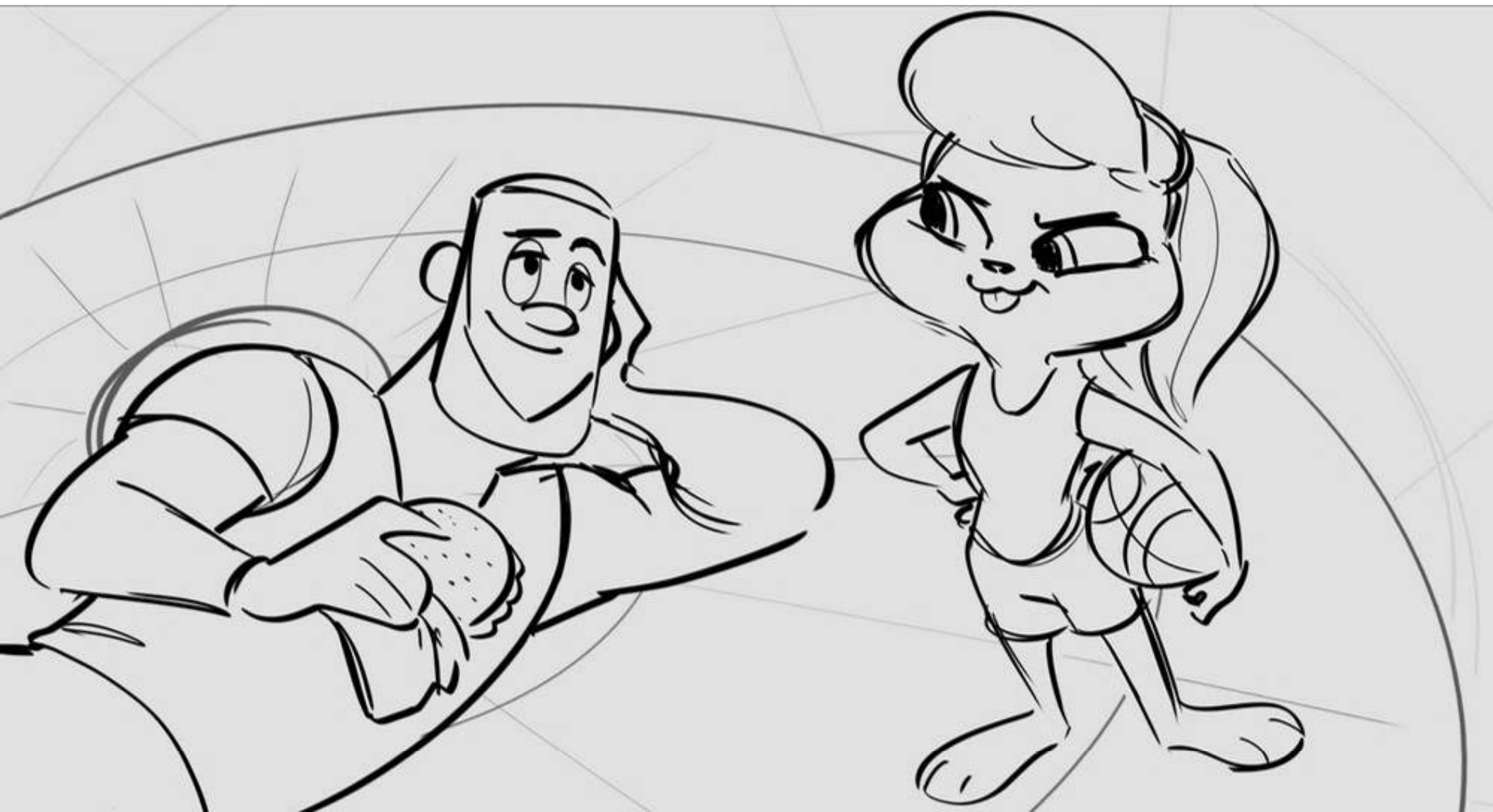

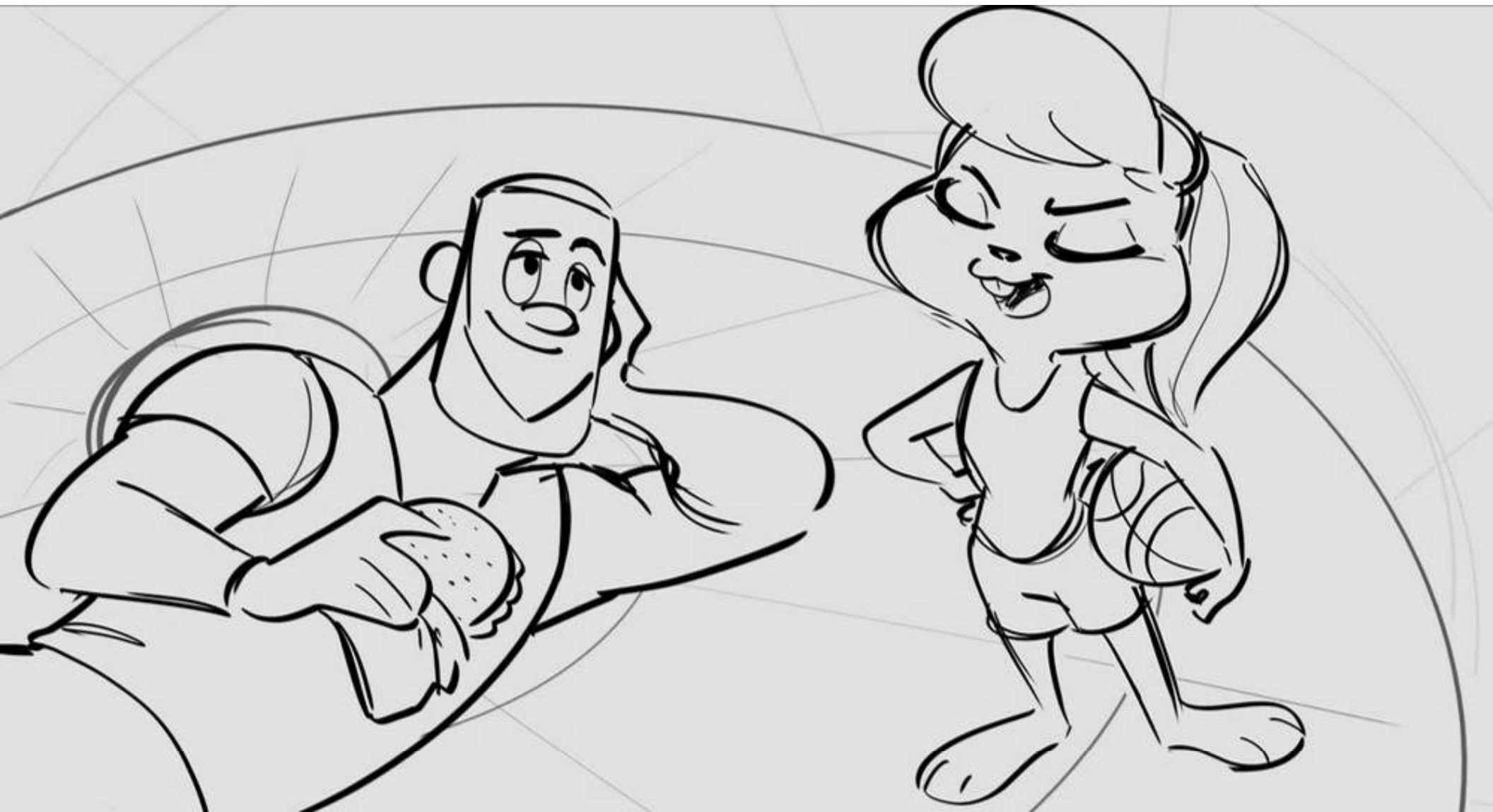

LOLA: I'm one of them.

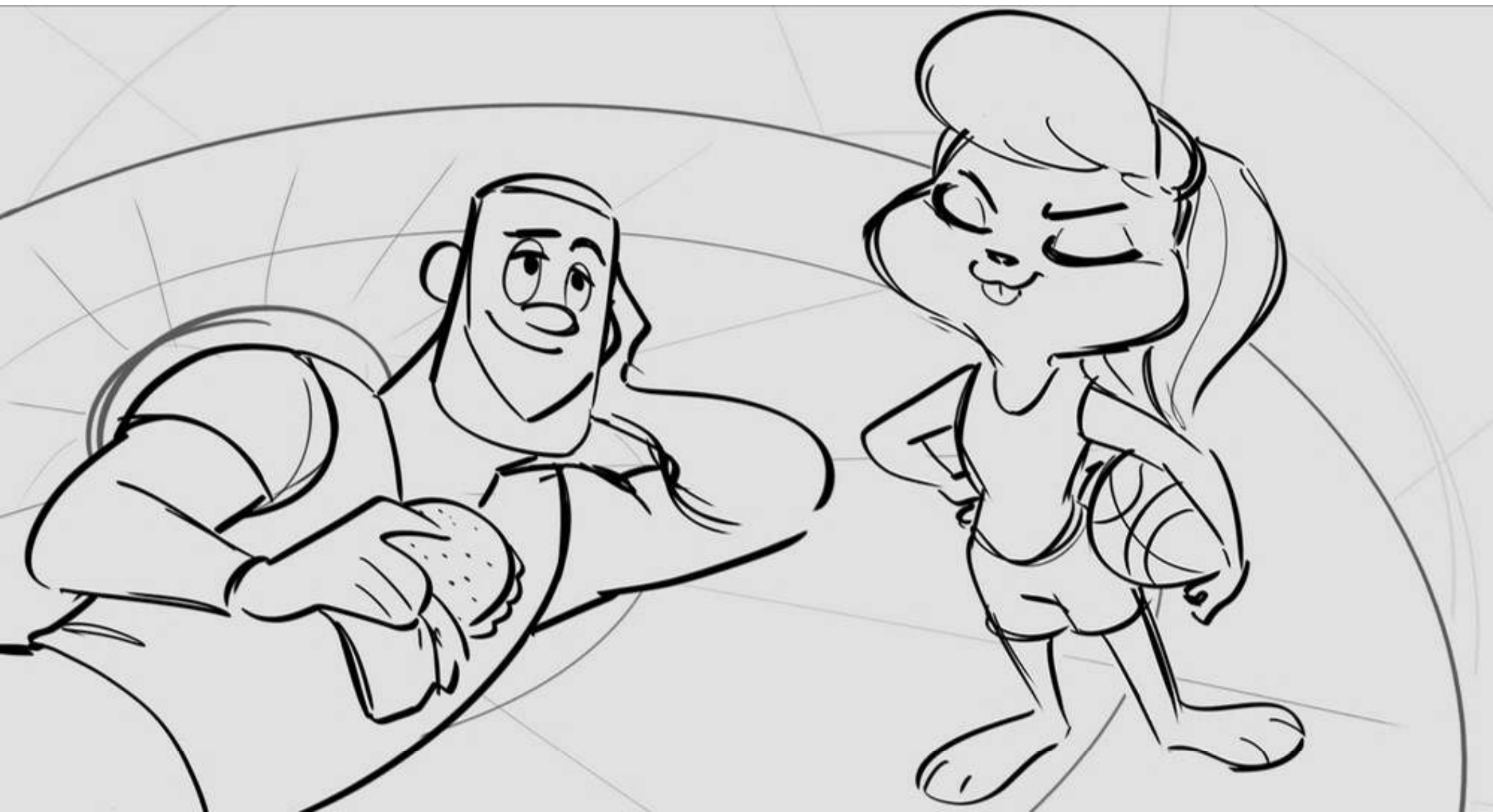



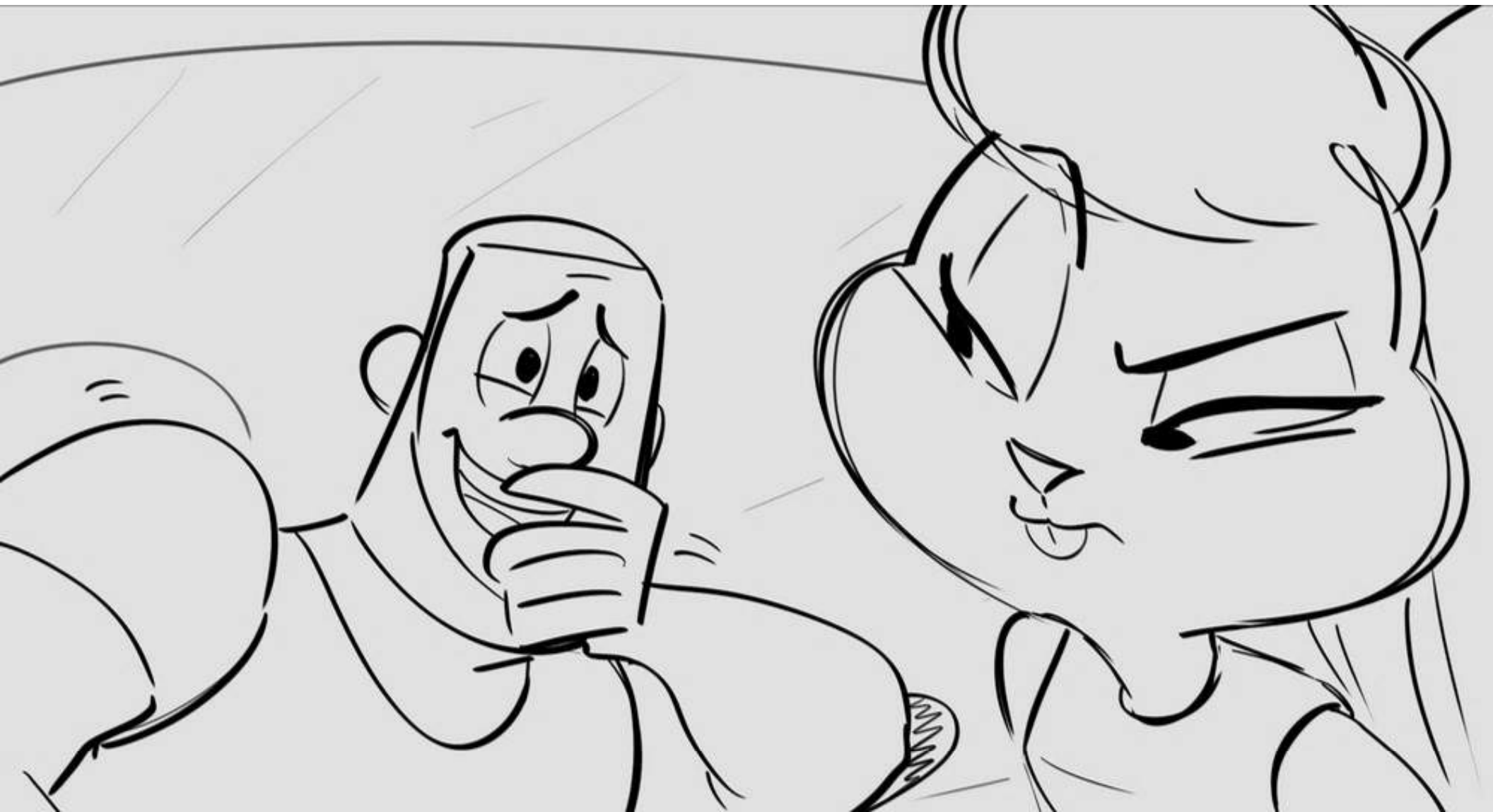

LEBRON: (guffaws)

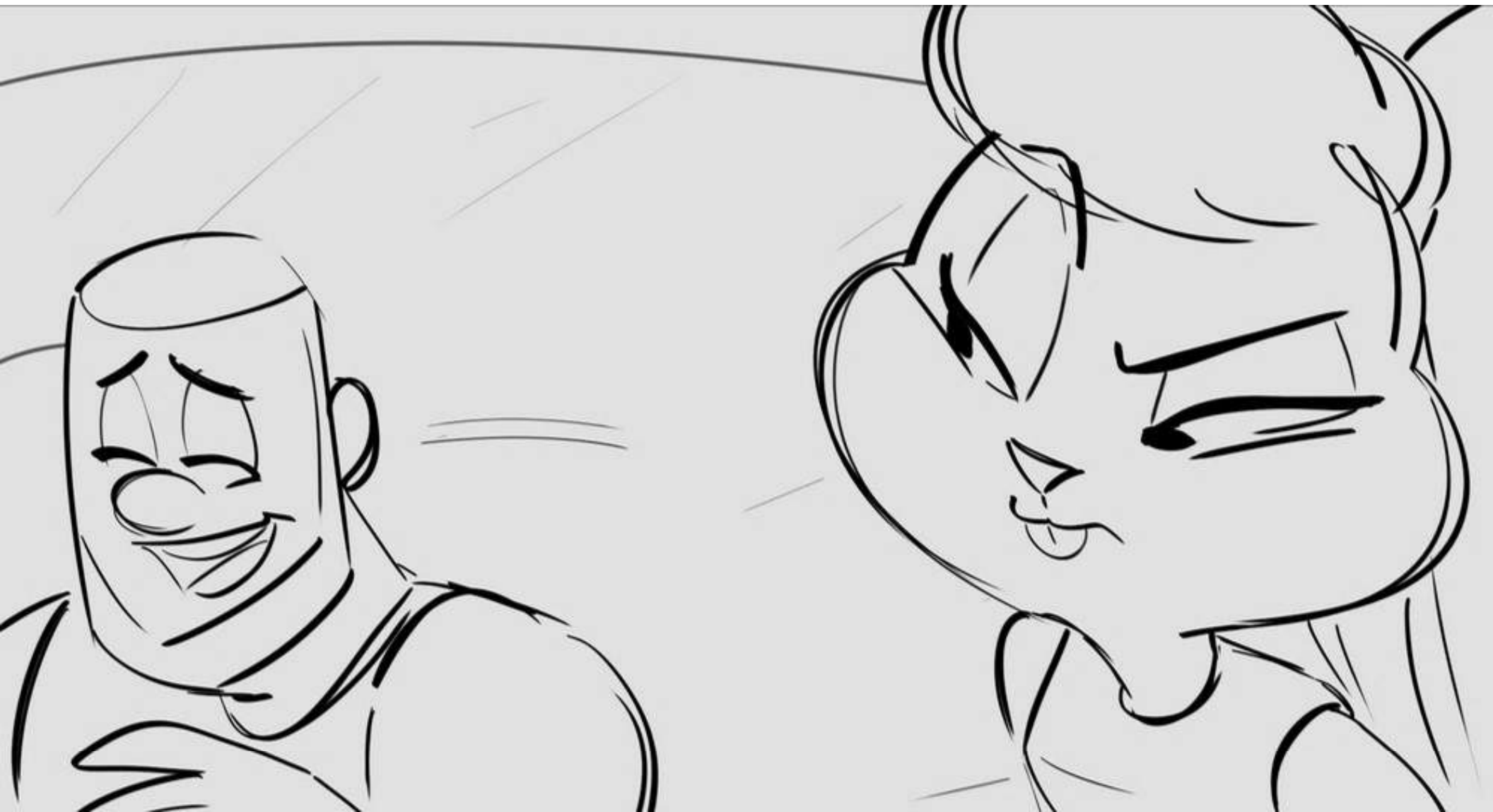

LEBRON: (guffaws)

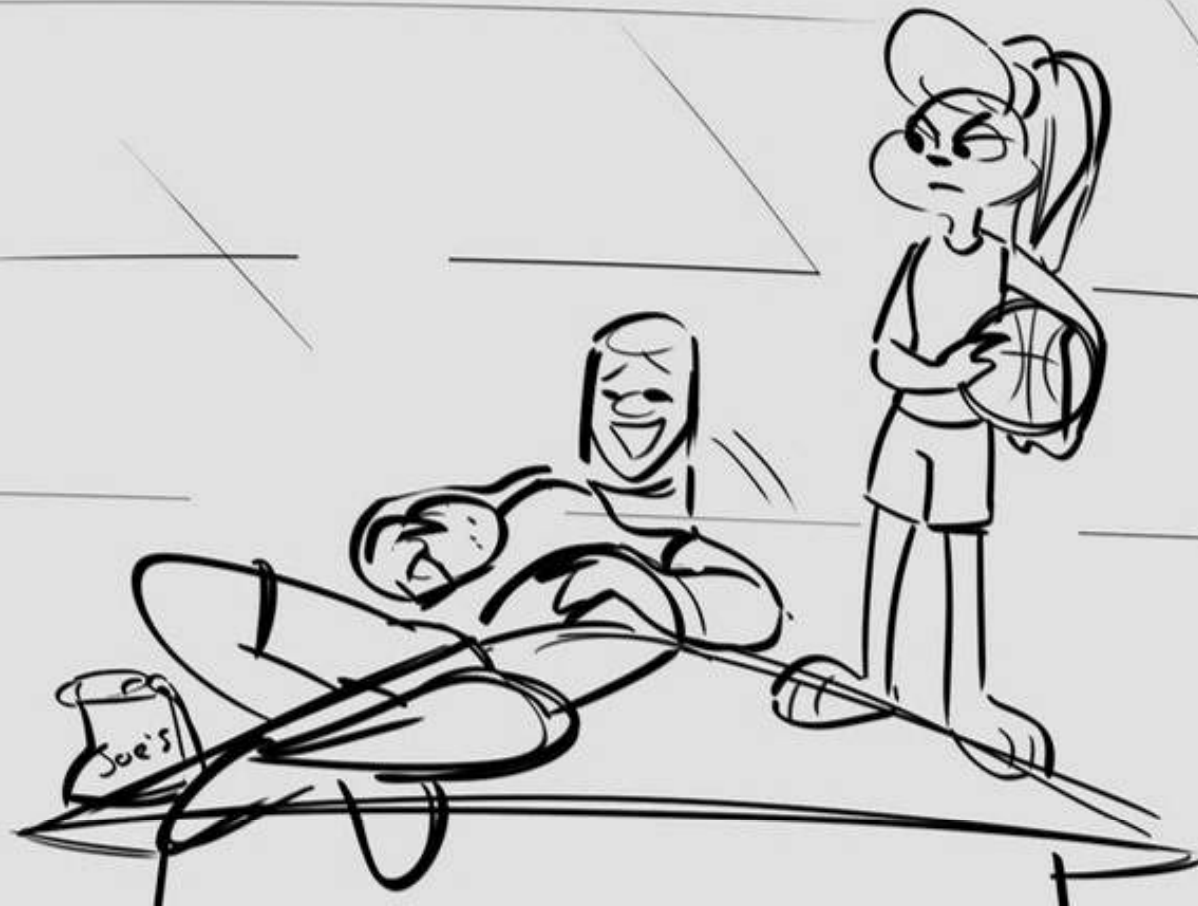





LOLA: I'm 3' 8" with ears!





LOLA: They push each other to grow.



LOLA: They push each other to grow.

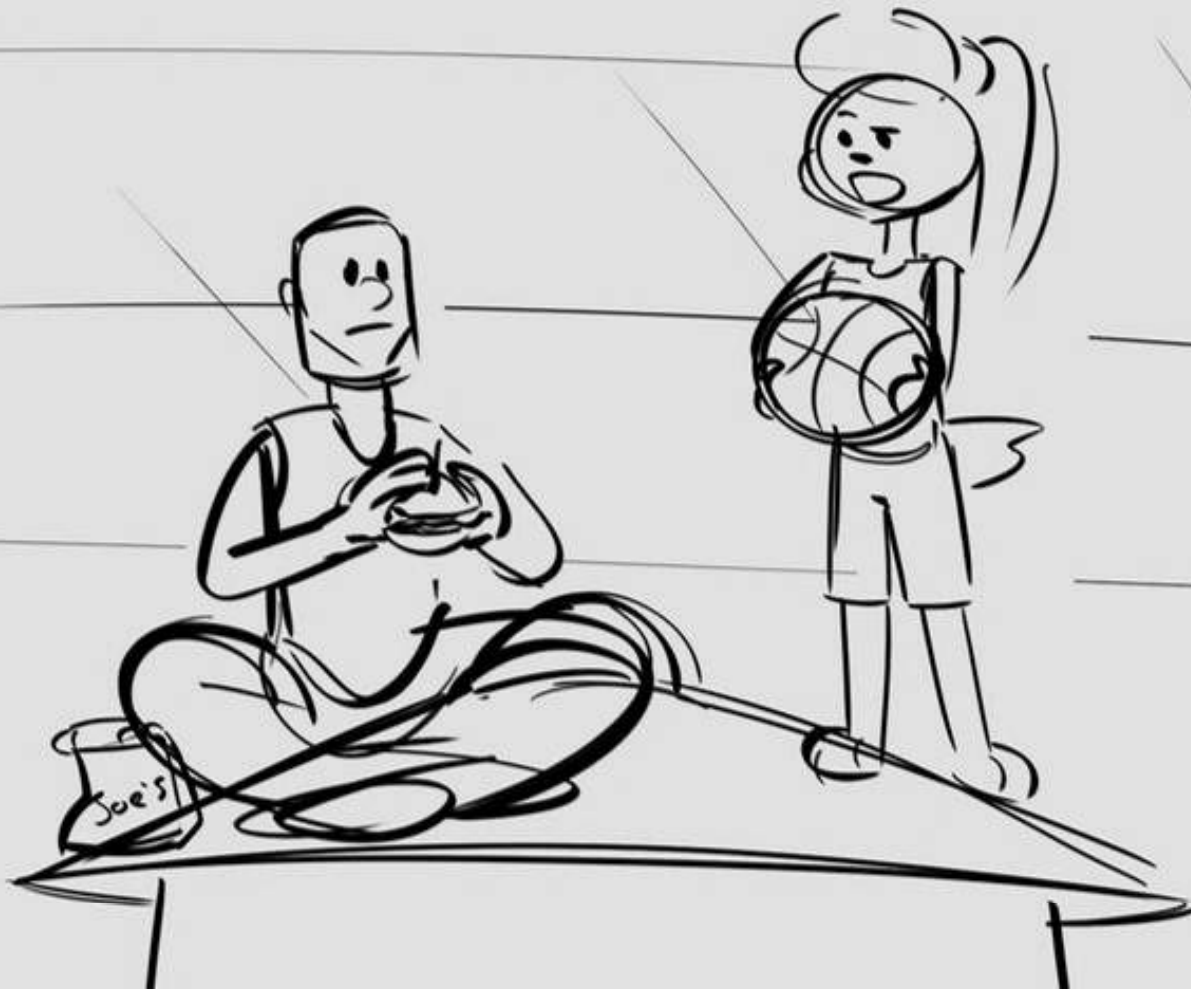

LOLA: They push ME to grow.

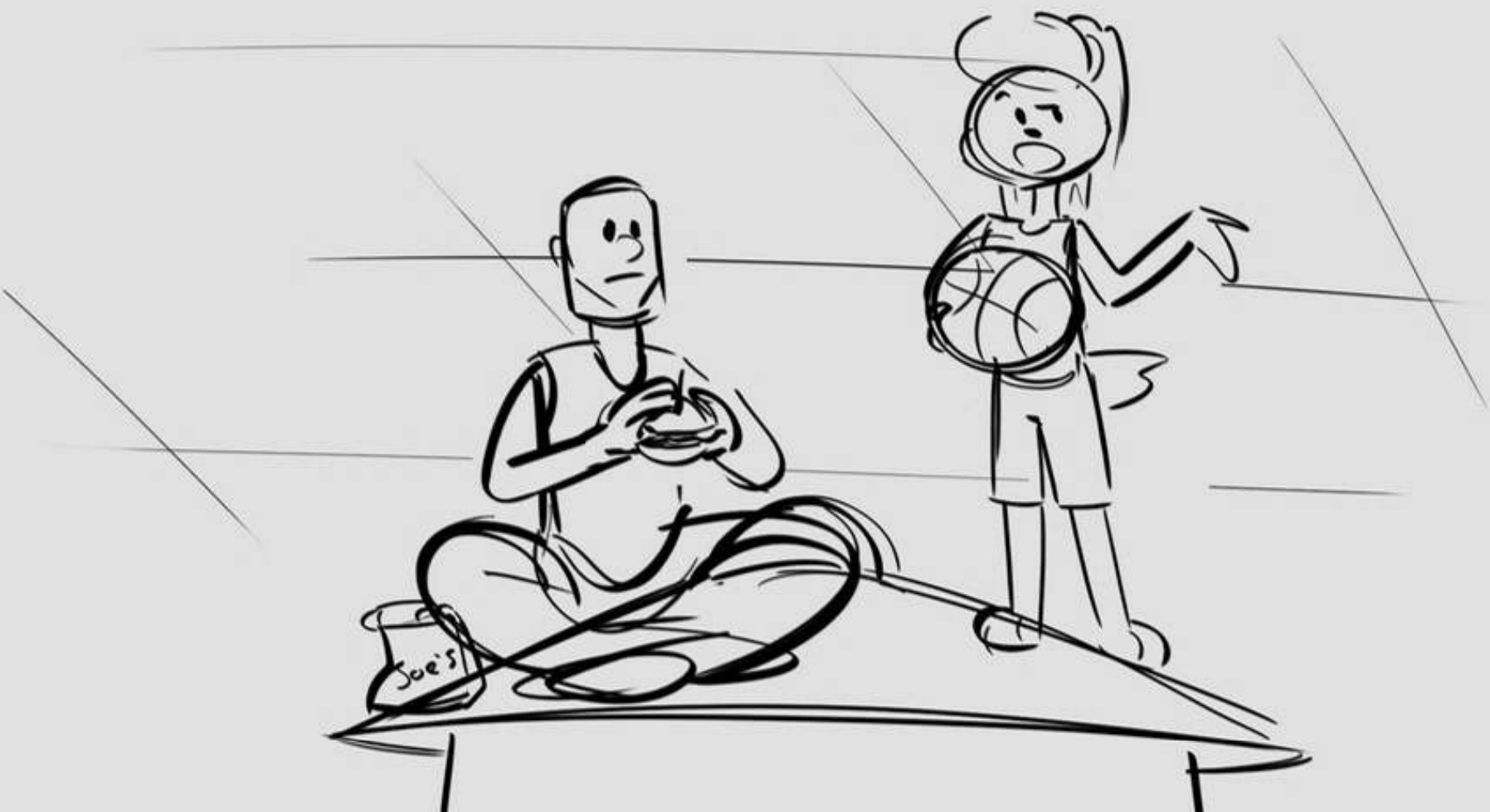

LOLA: They aren't...stuck.





LOLA: Awning,



LOLA: weathervane,



LOLA: mailbox,



LOLA: net.

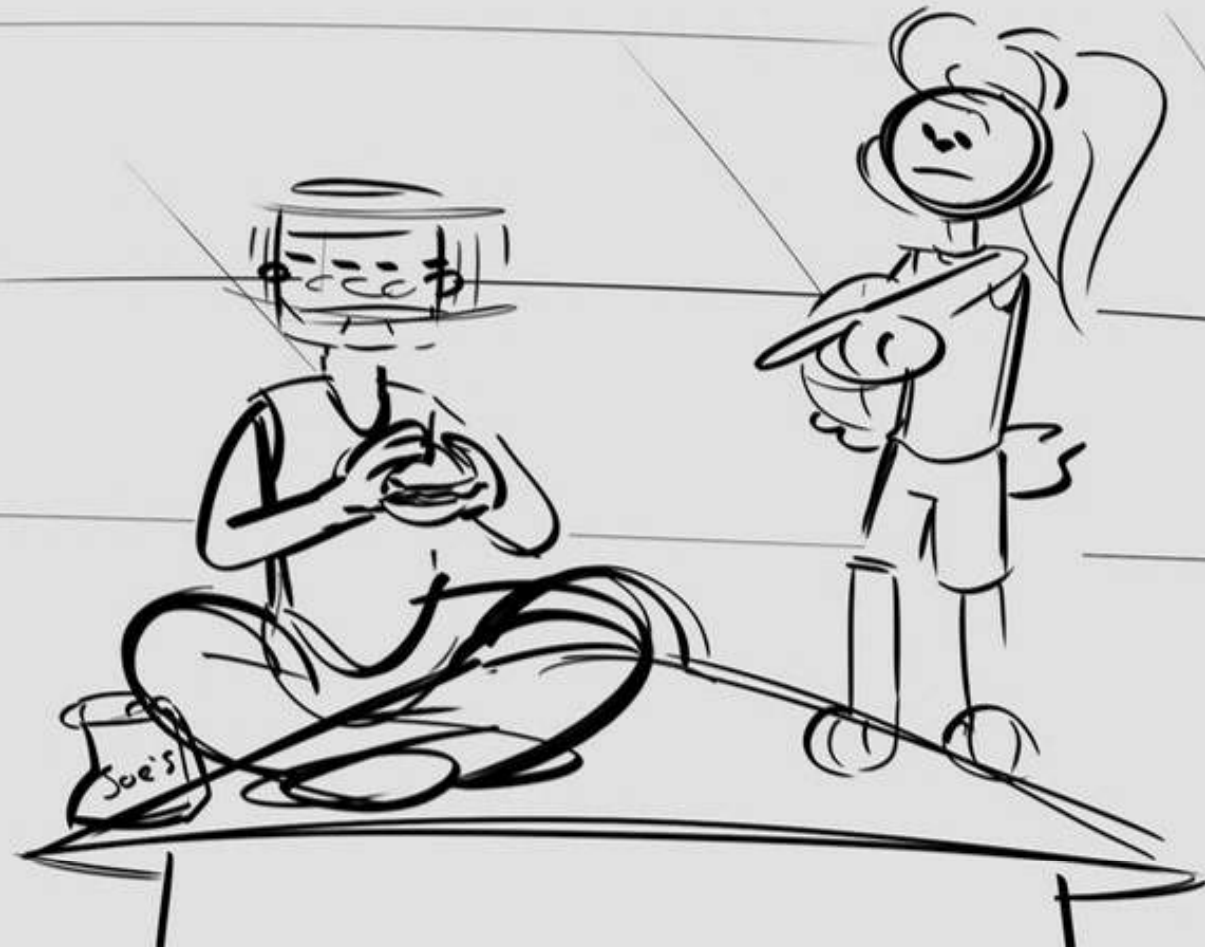











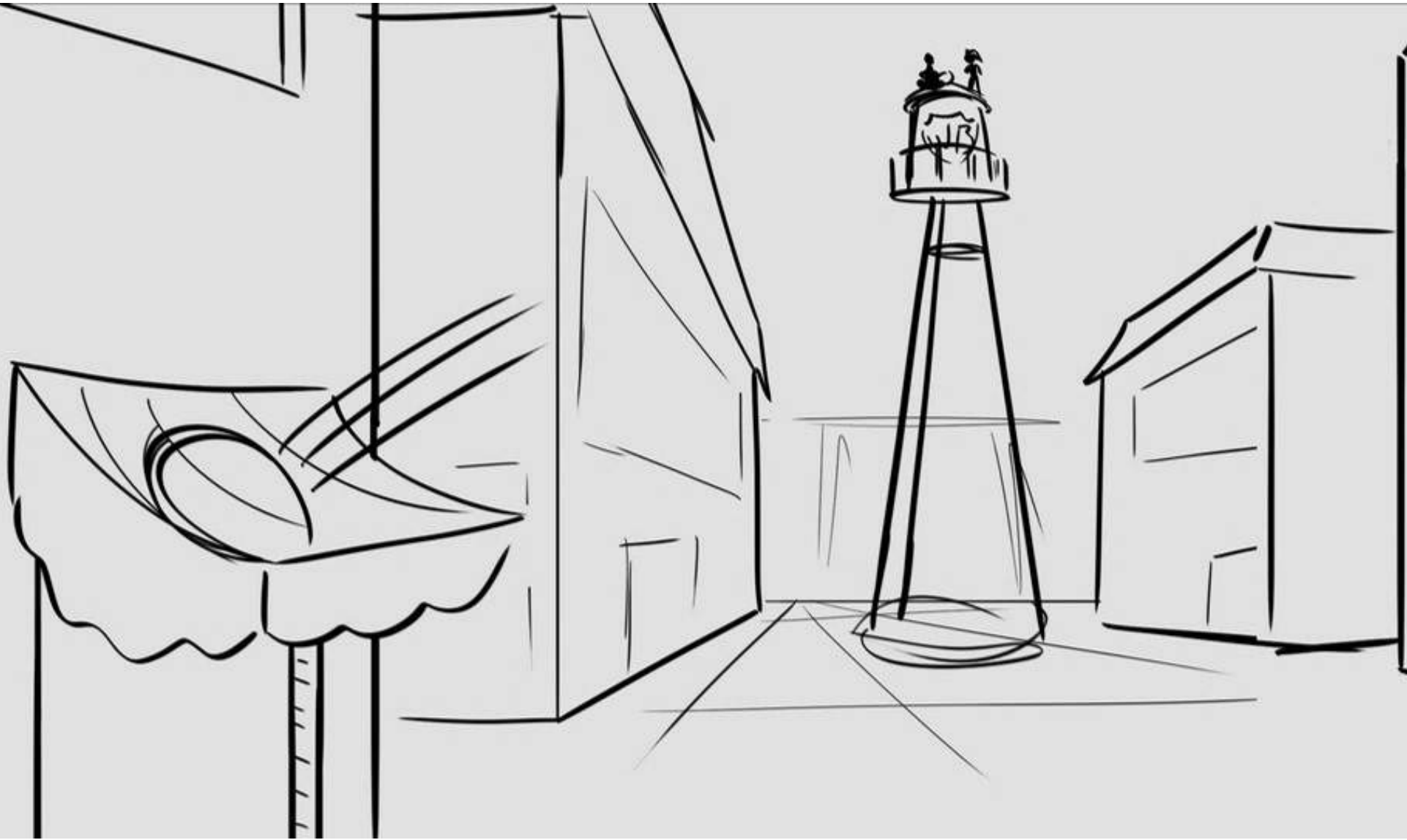

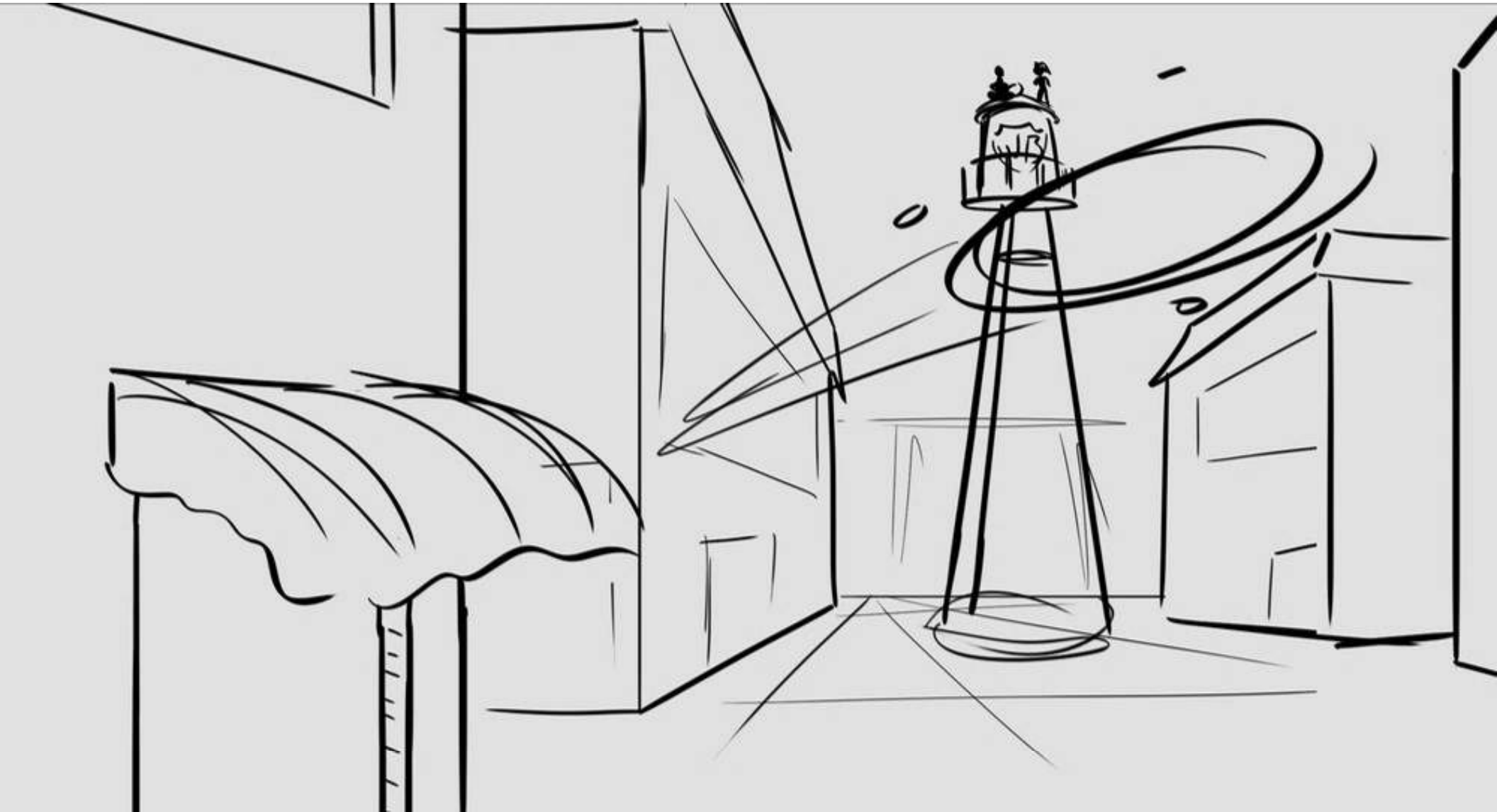



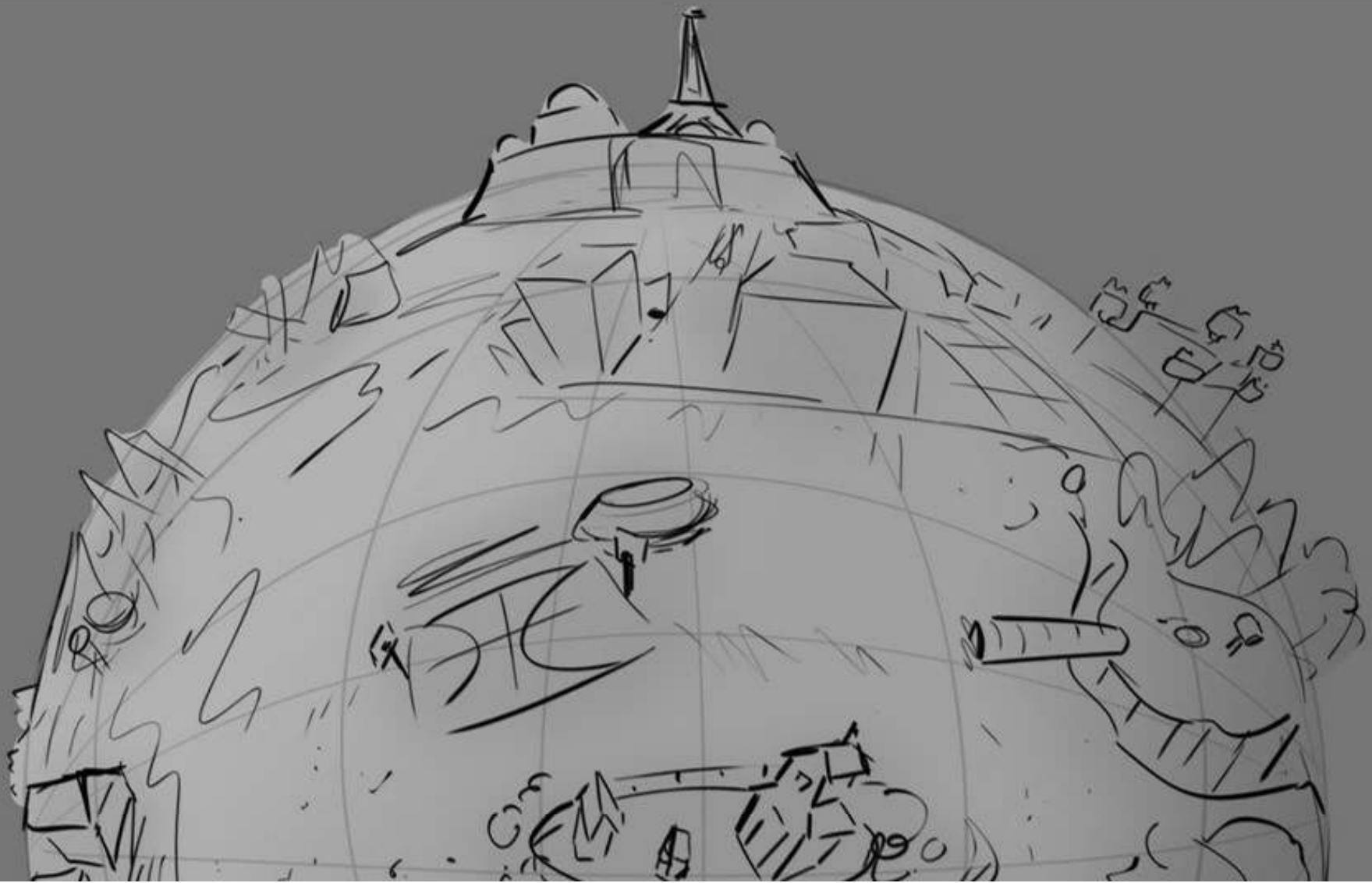

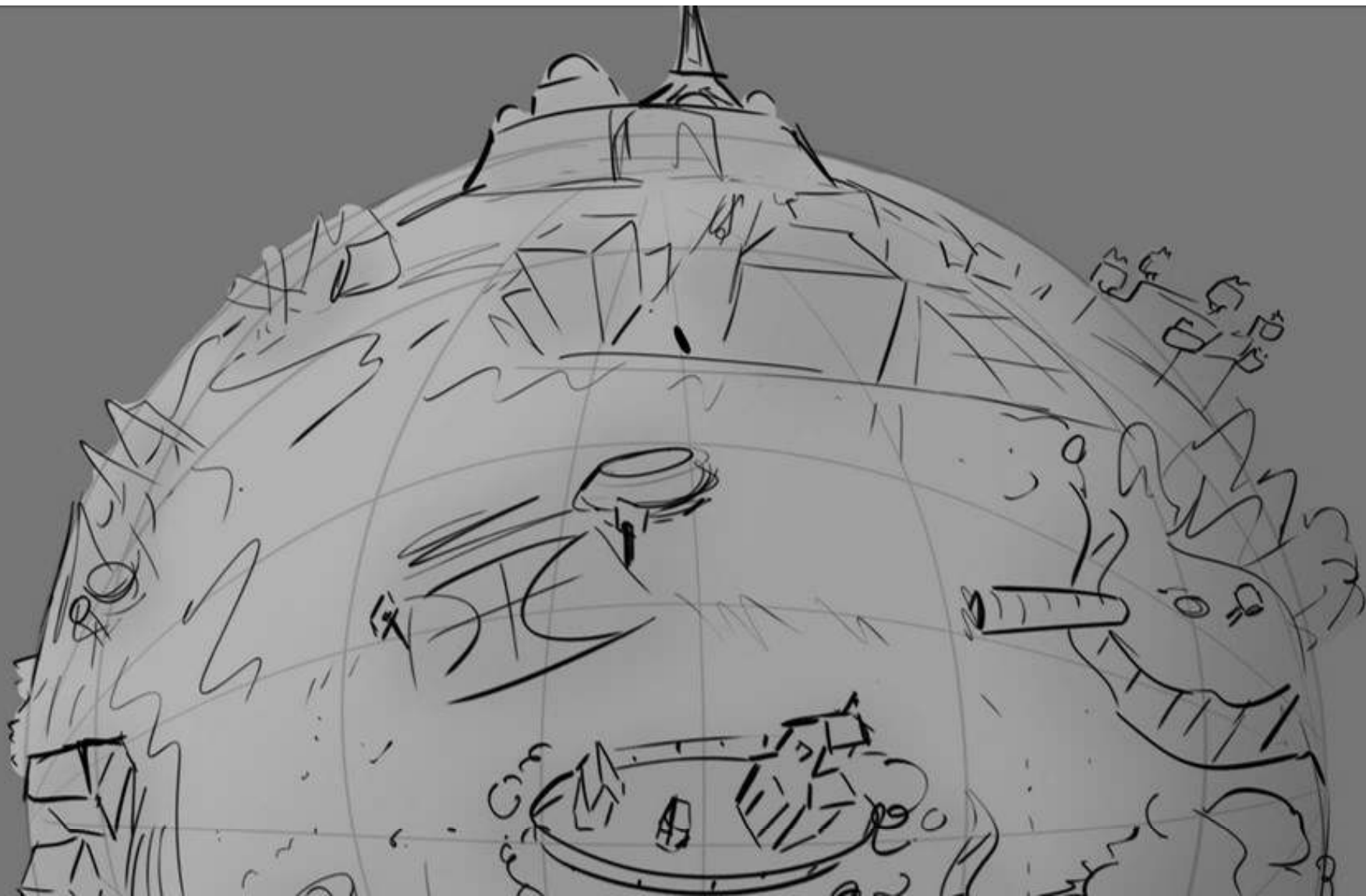

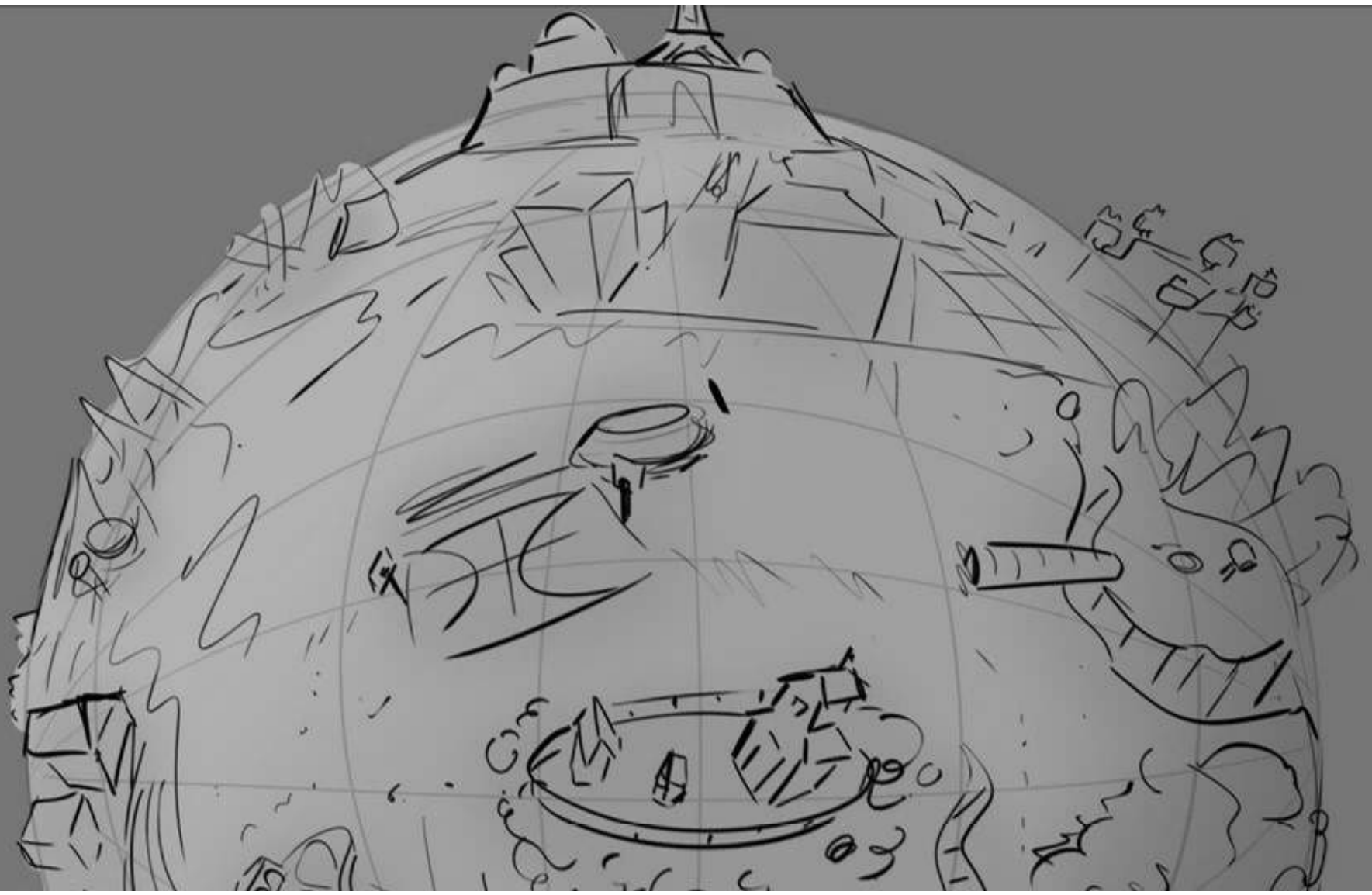

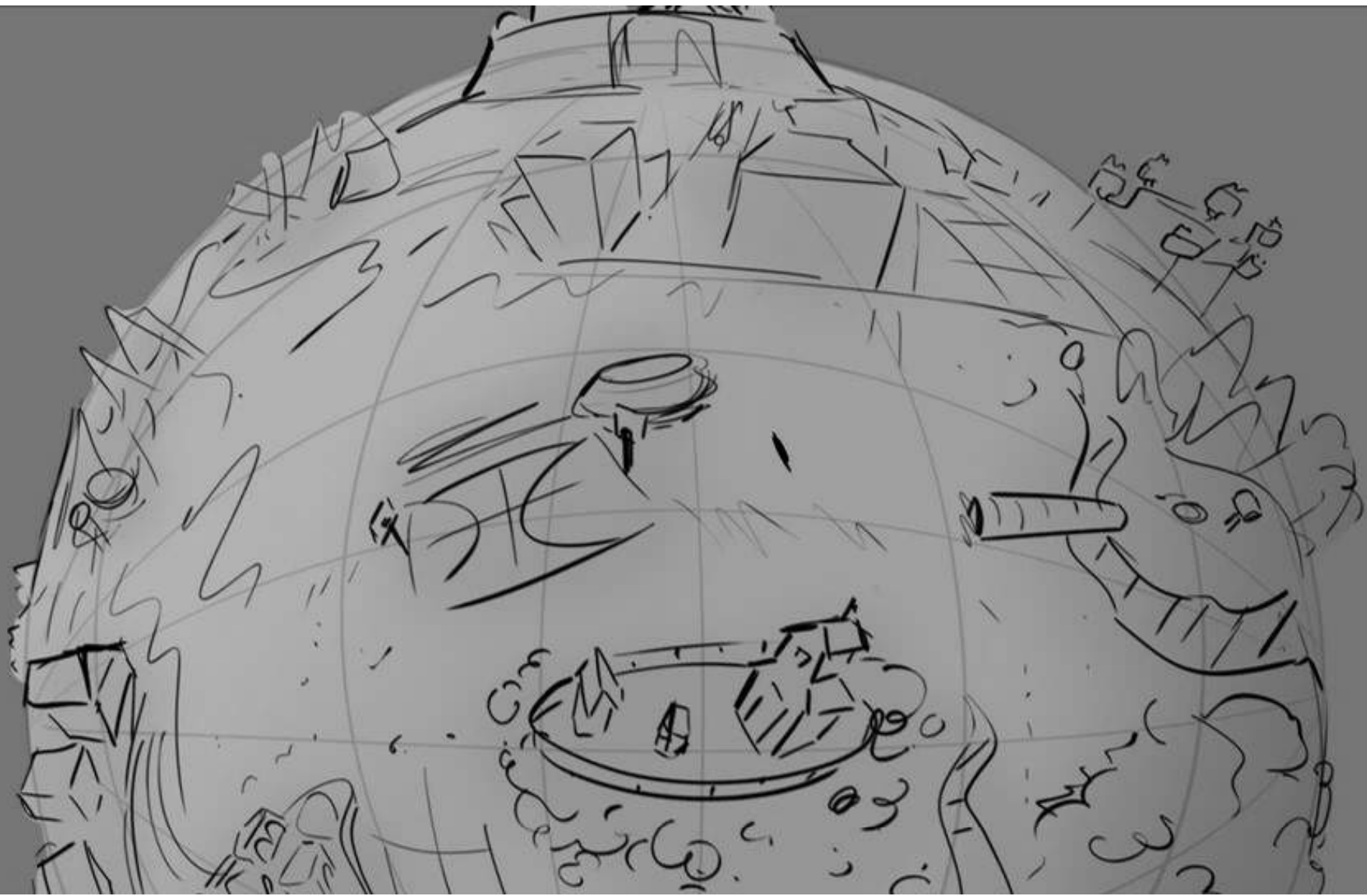

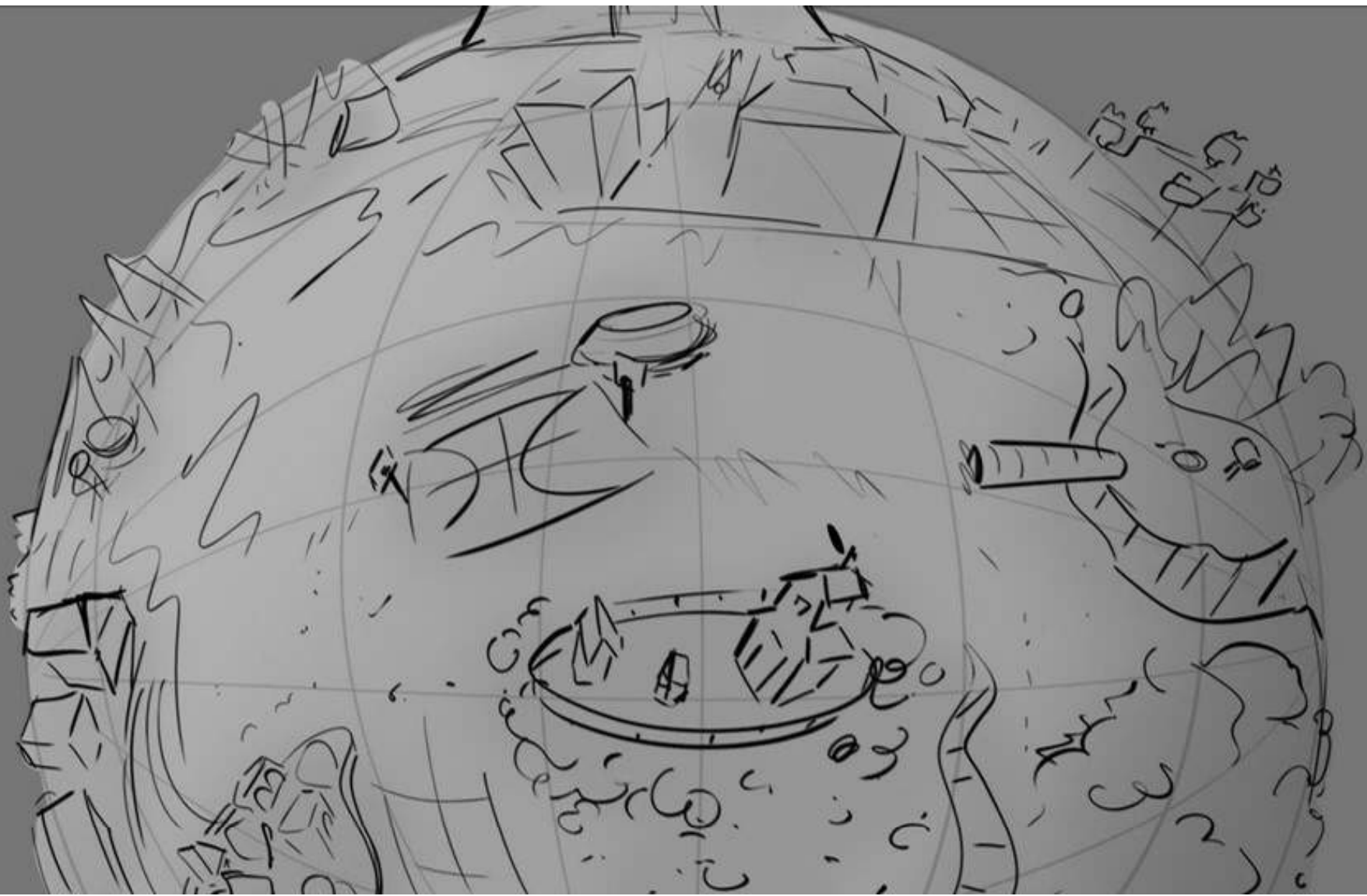

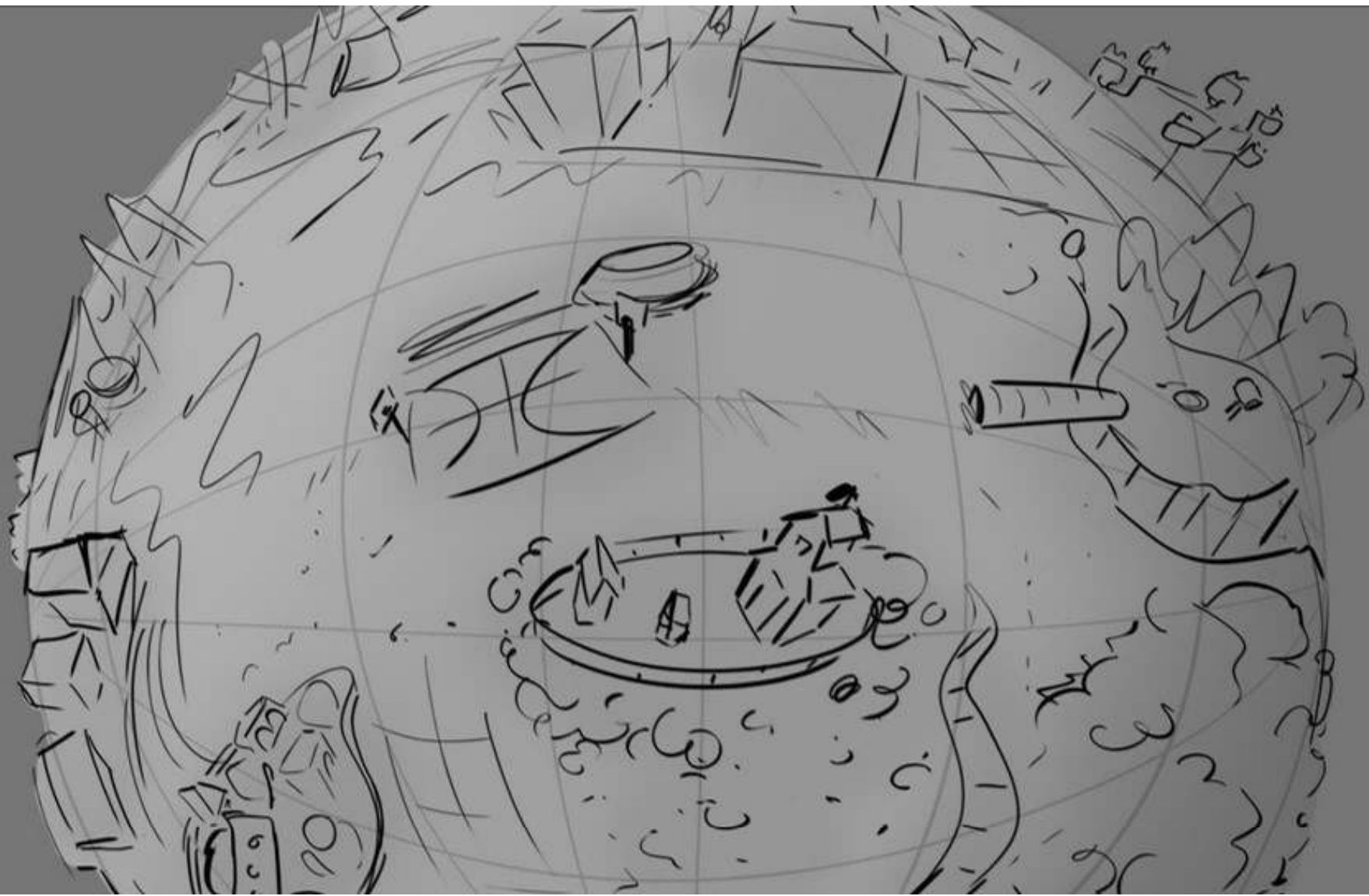

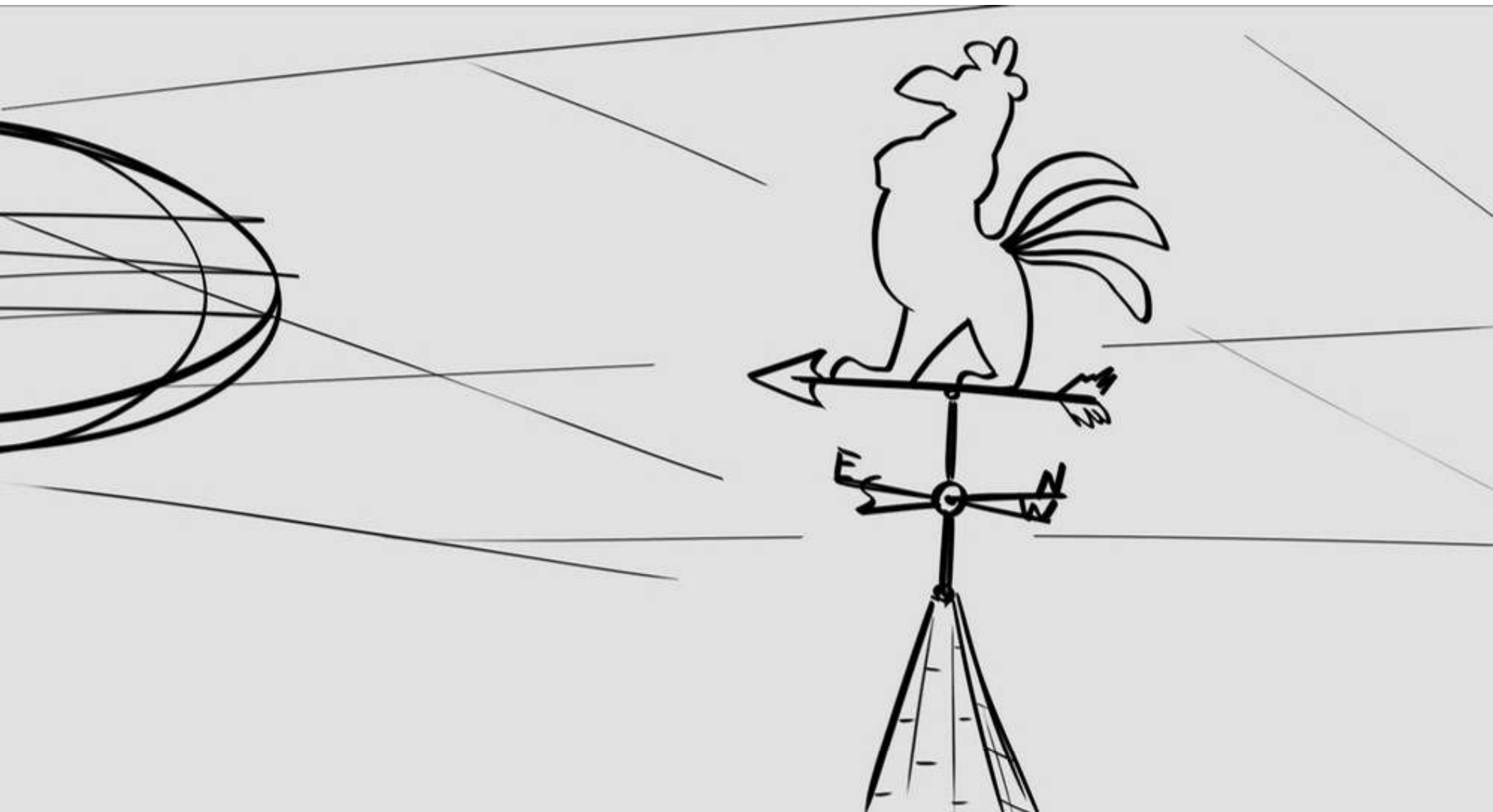

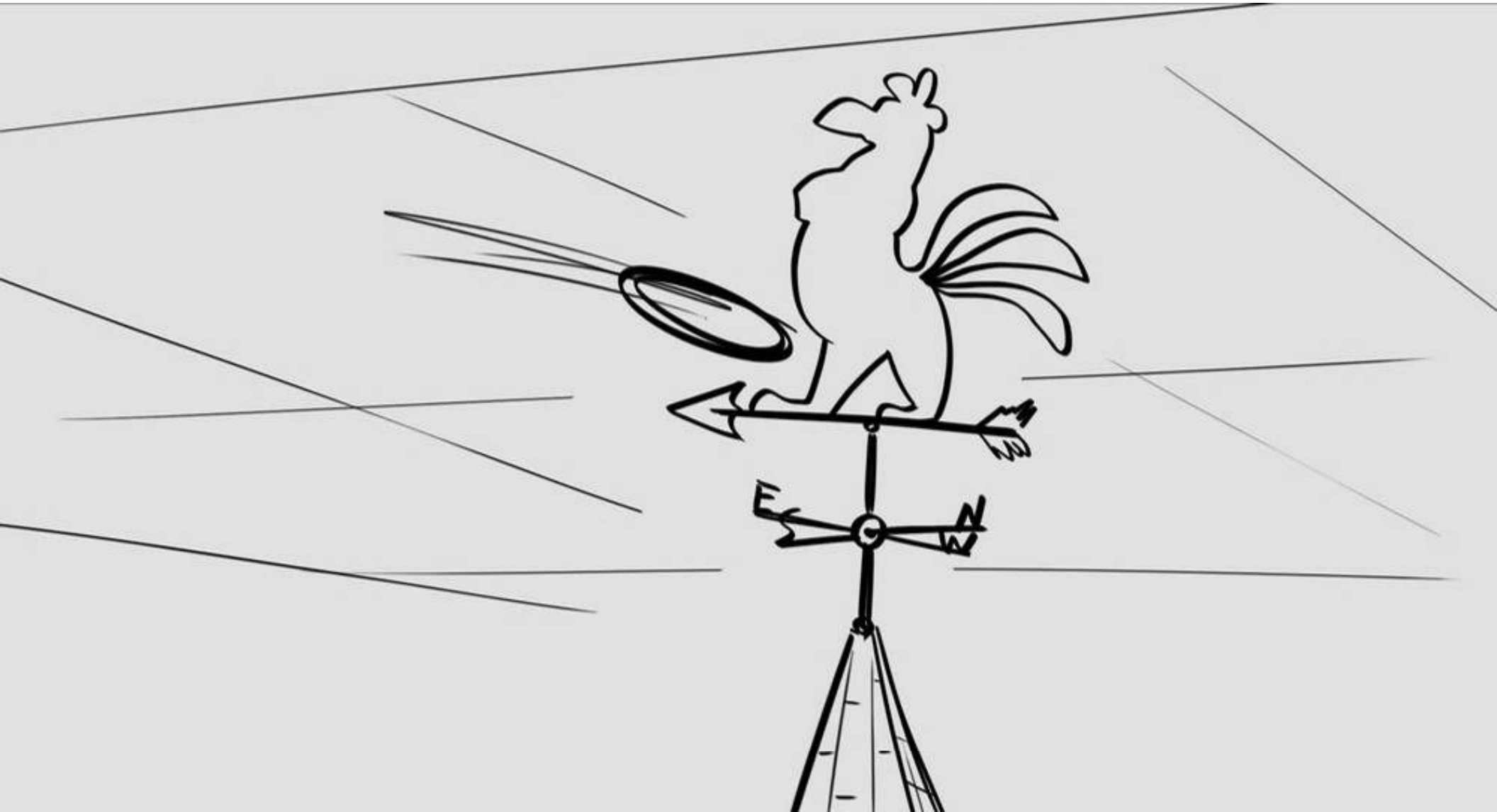

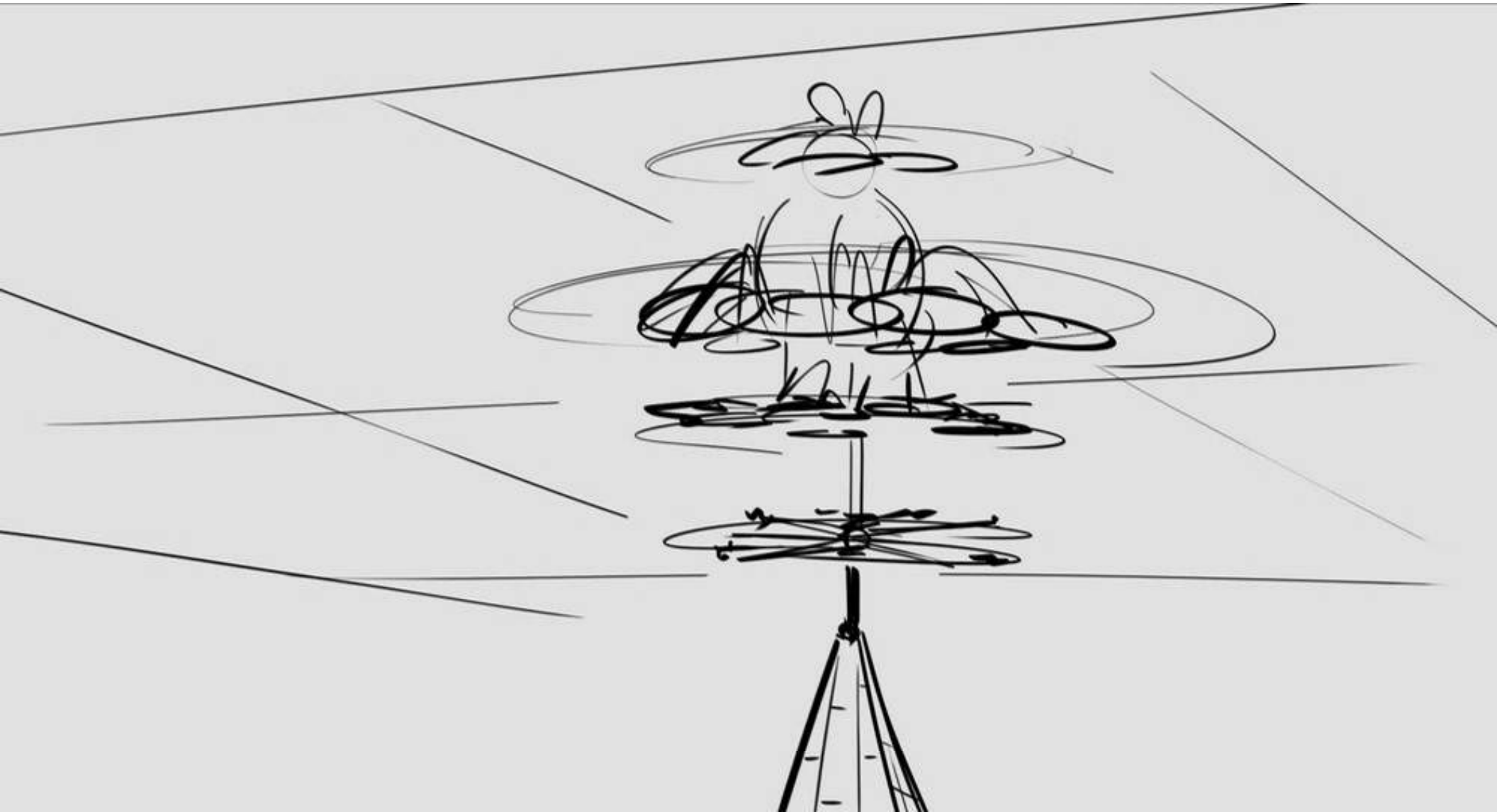

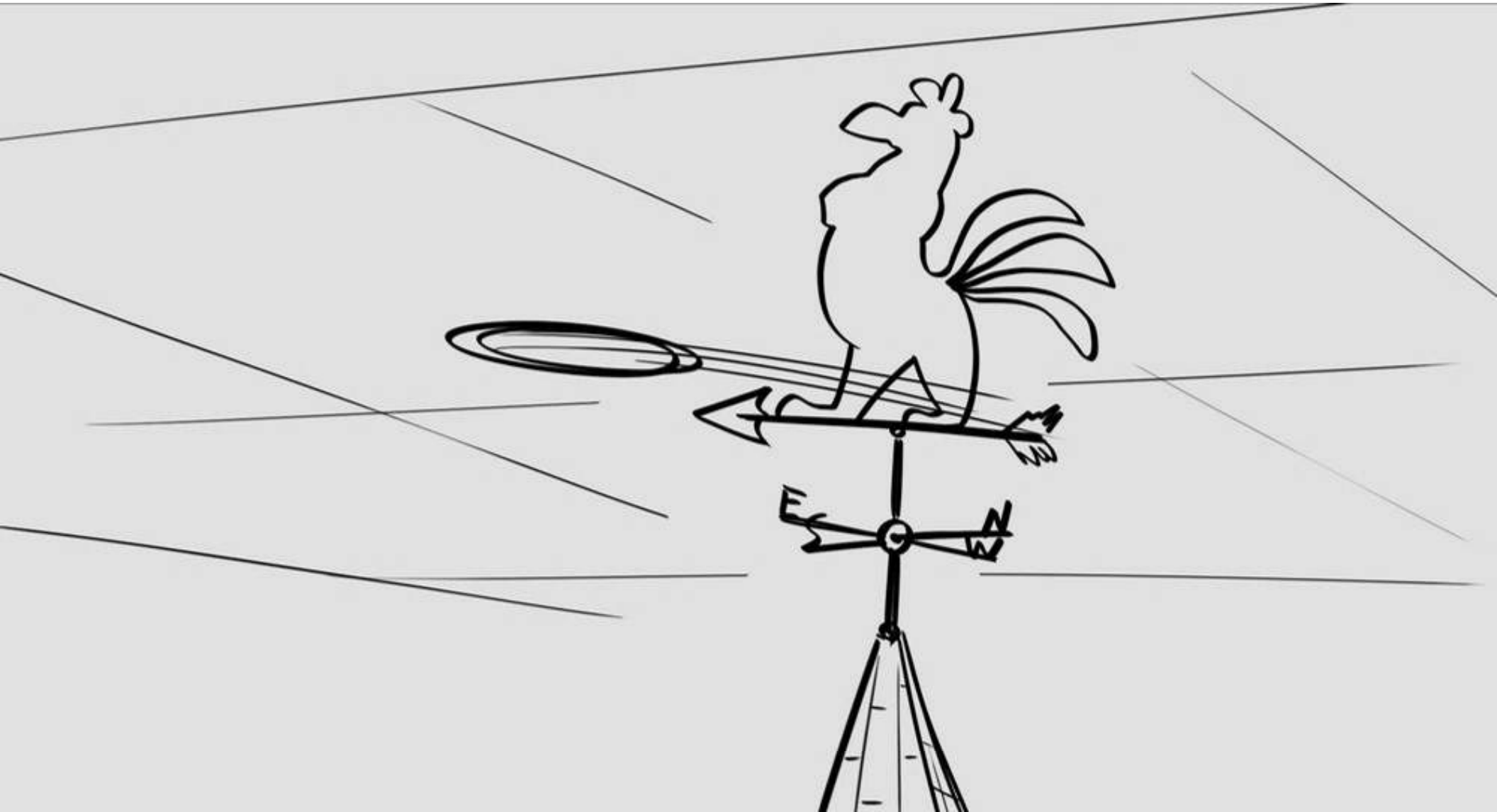

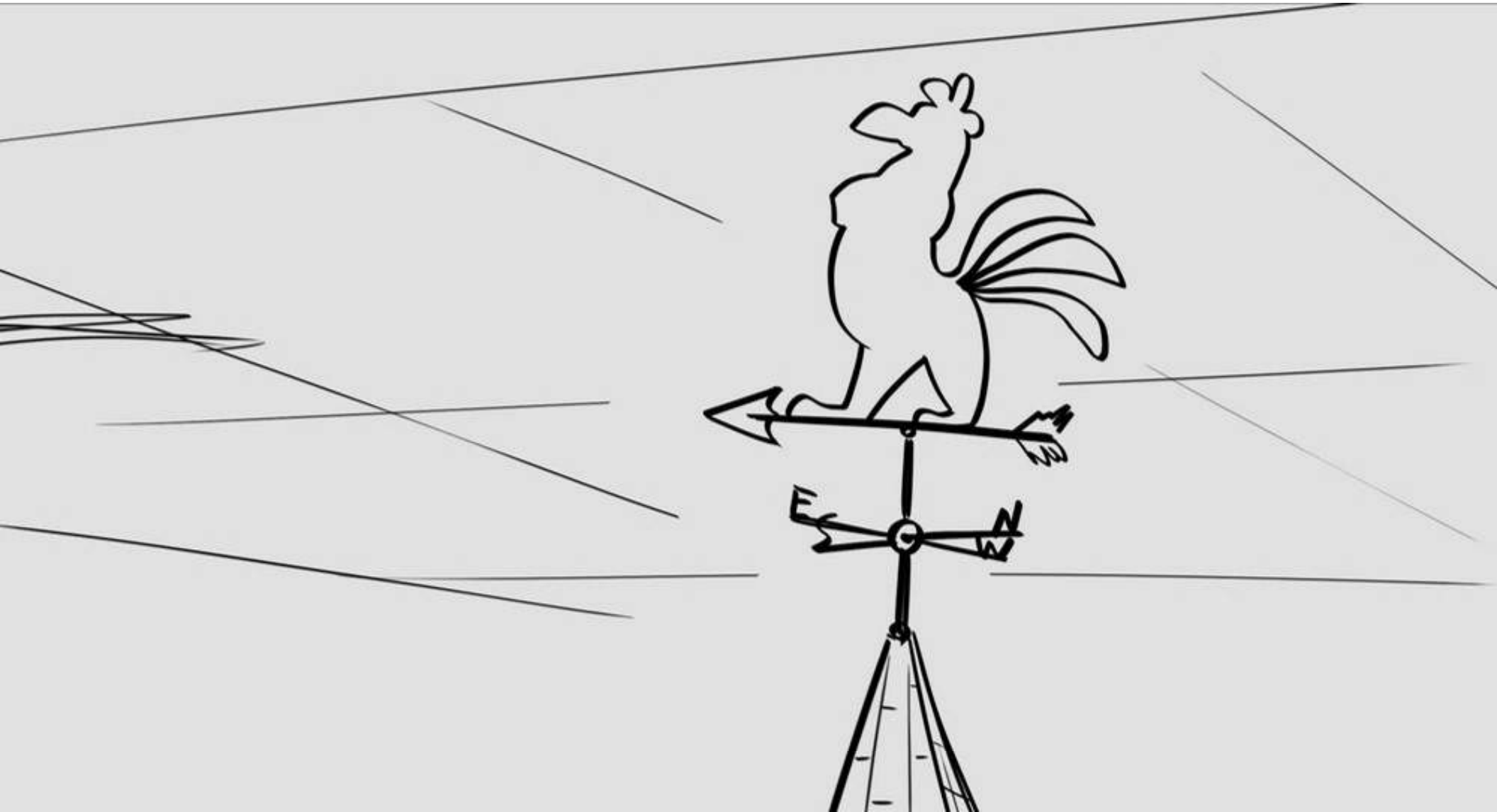

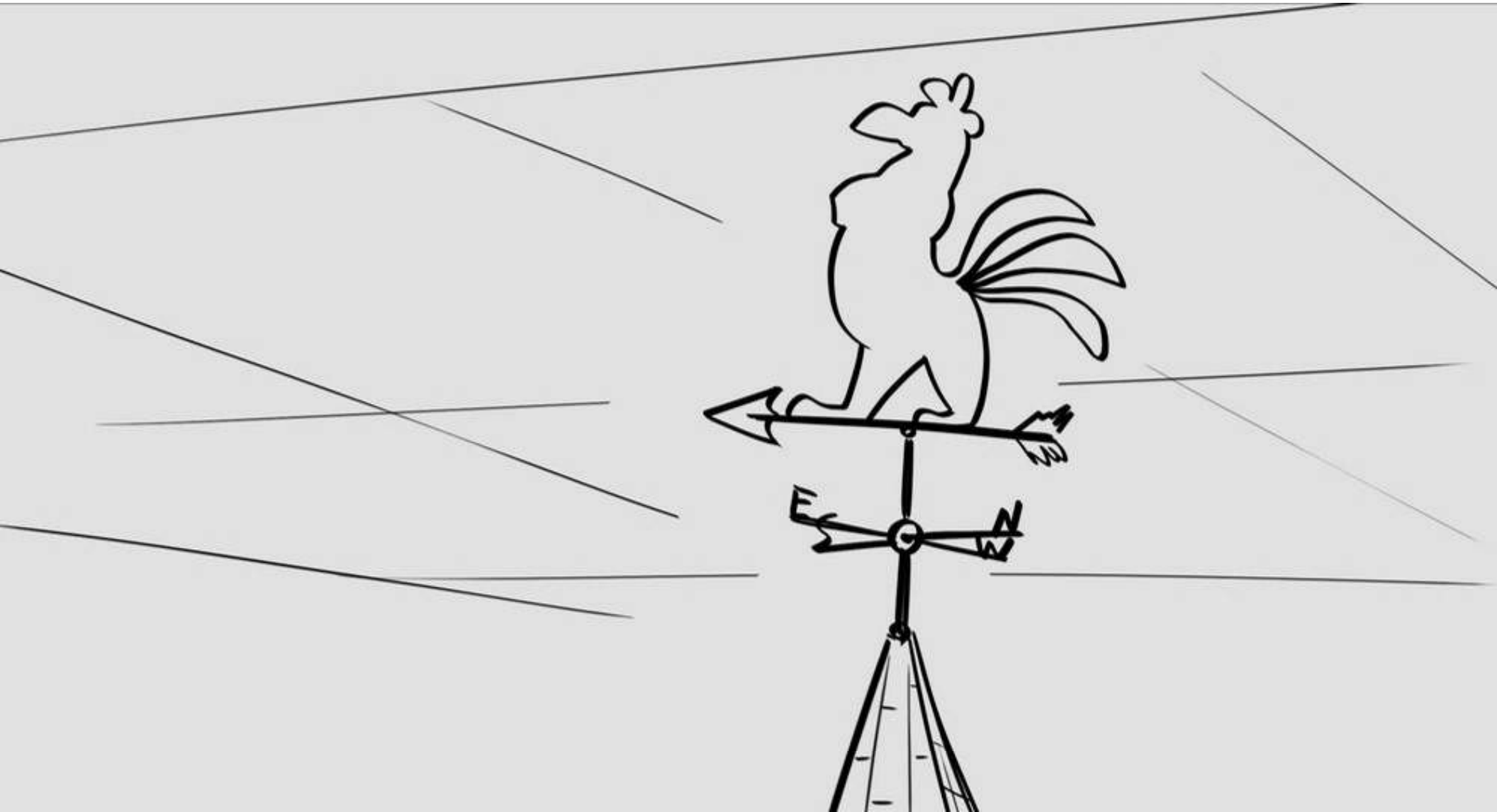

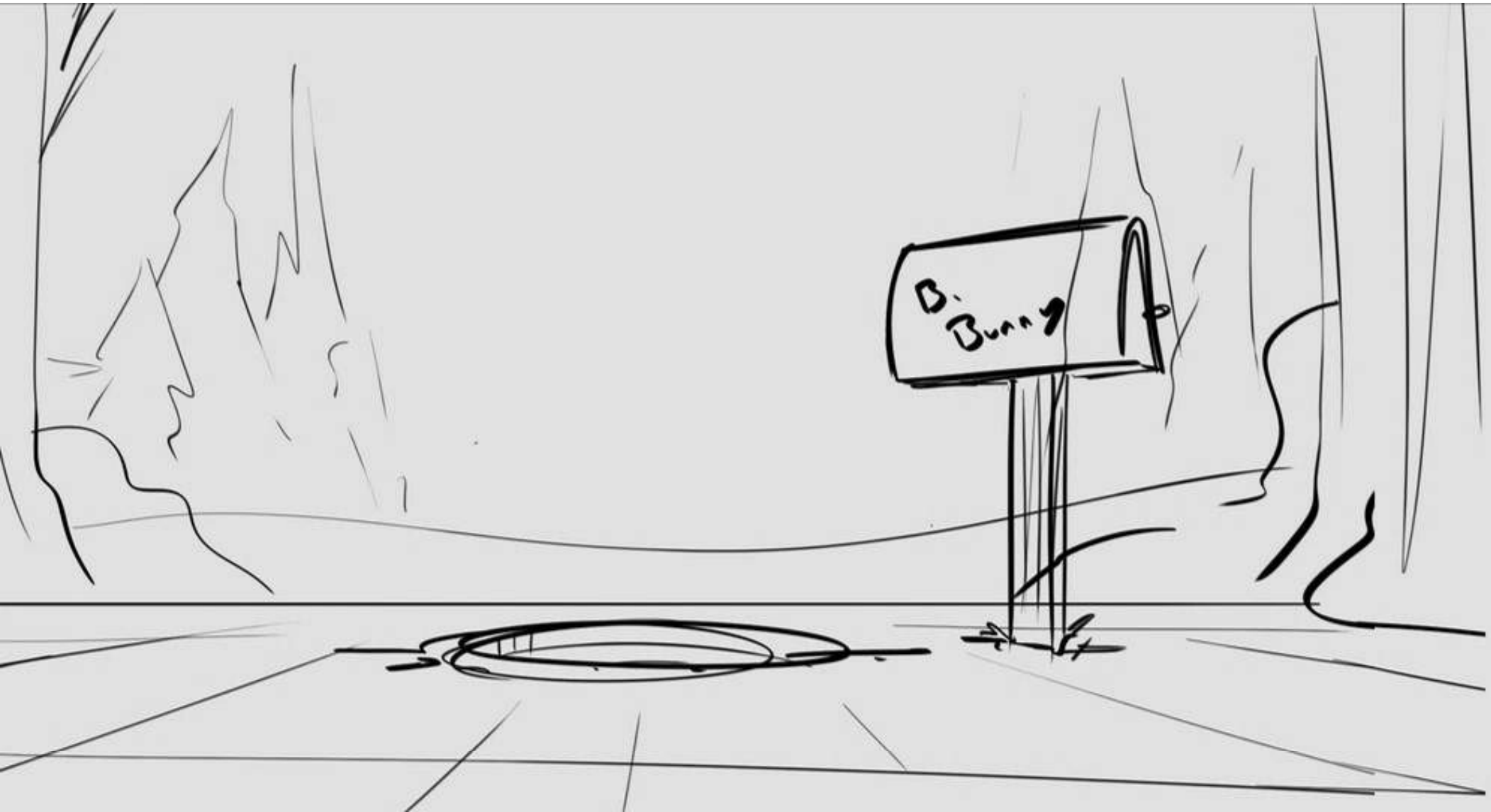

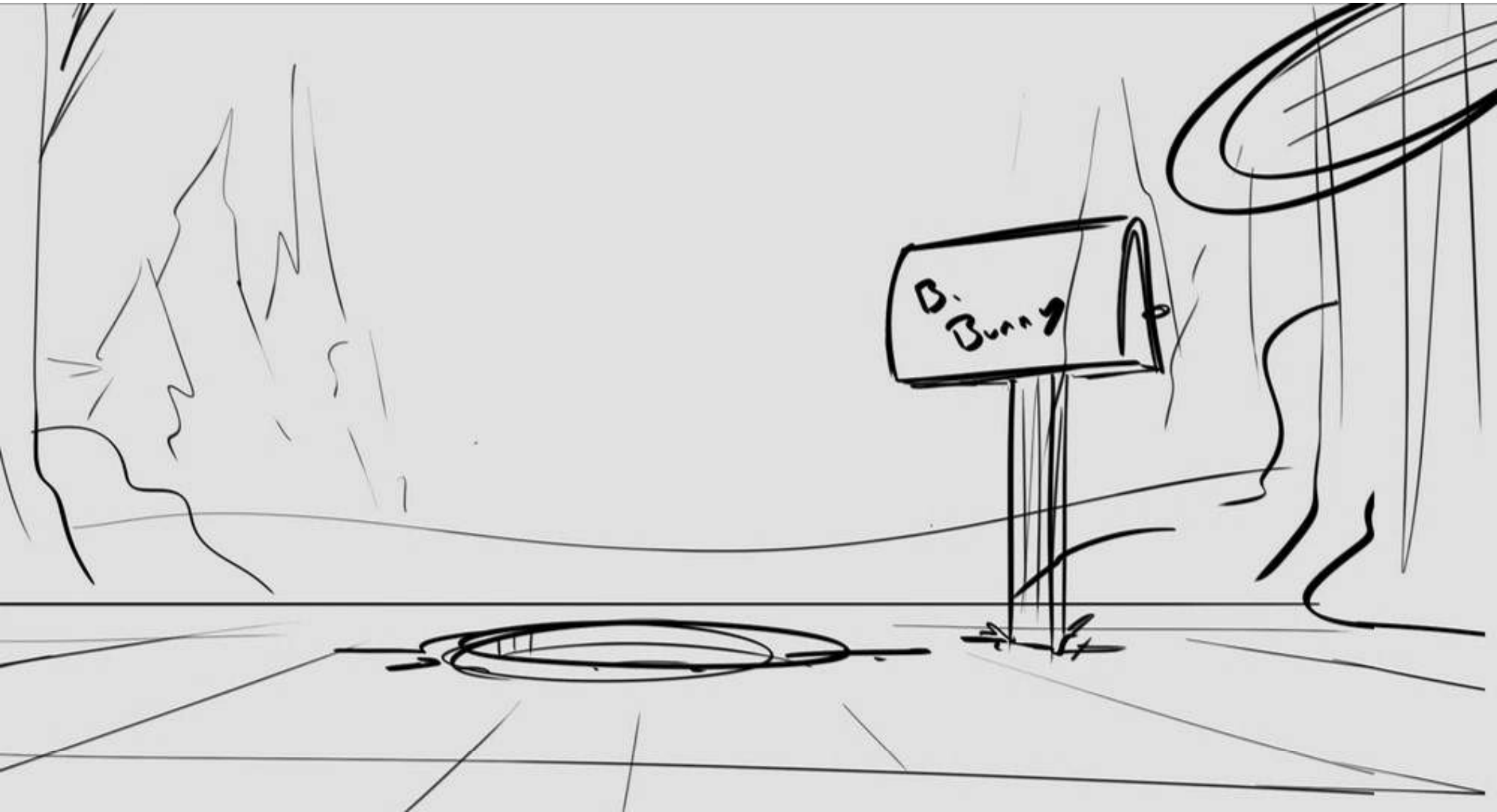

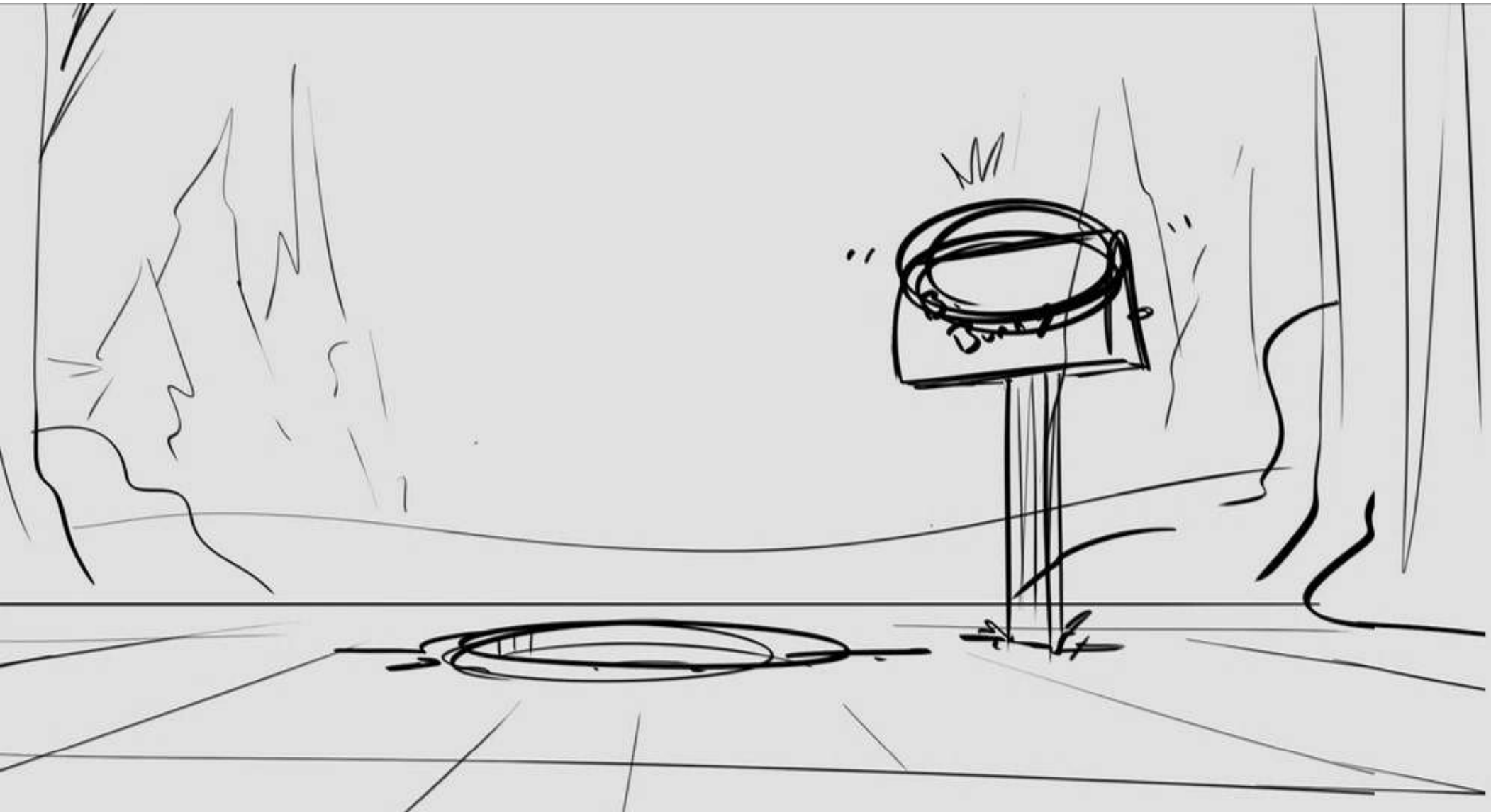

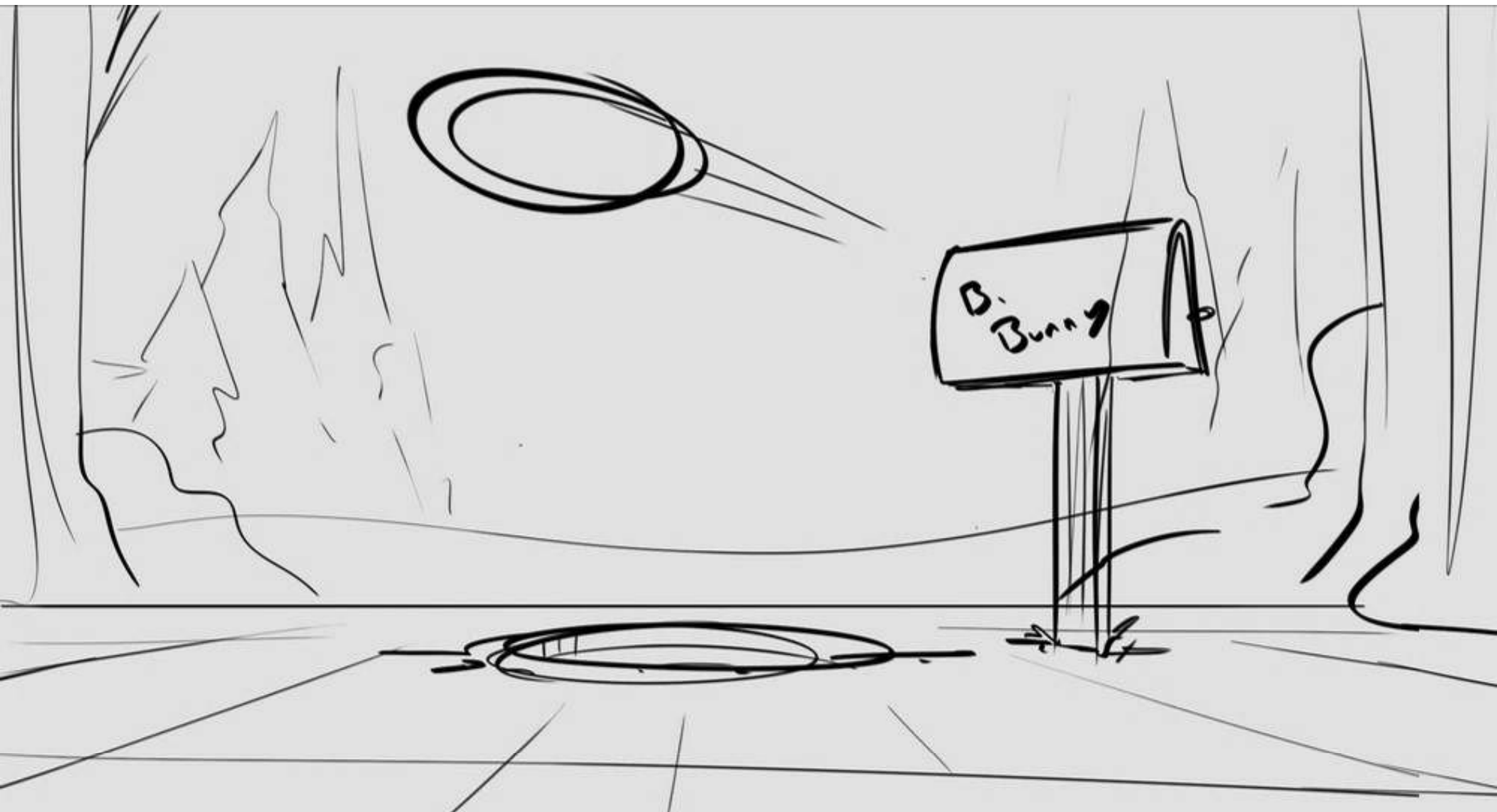

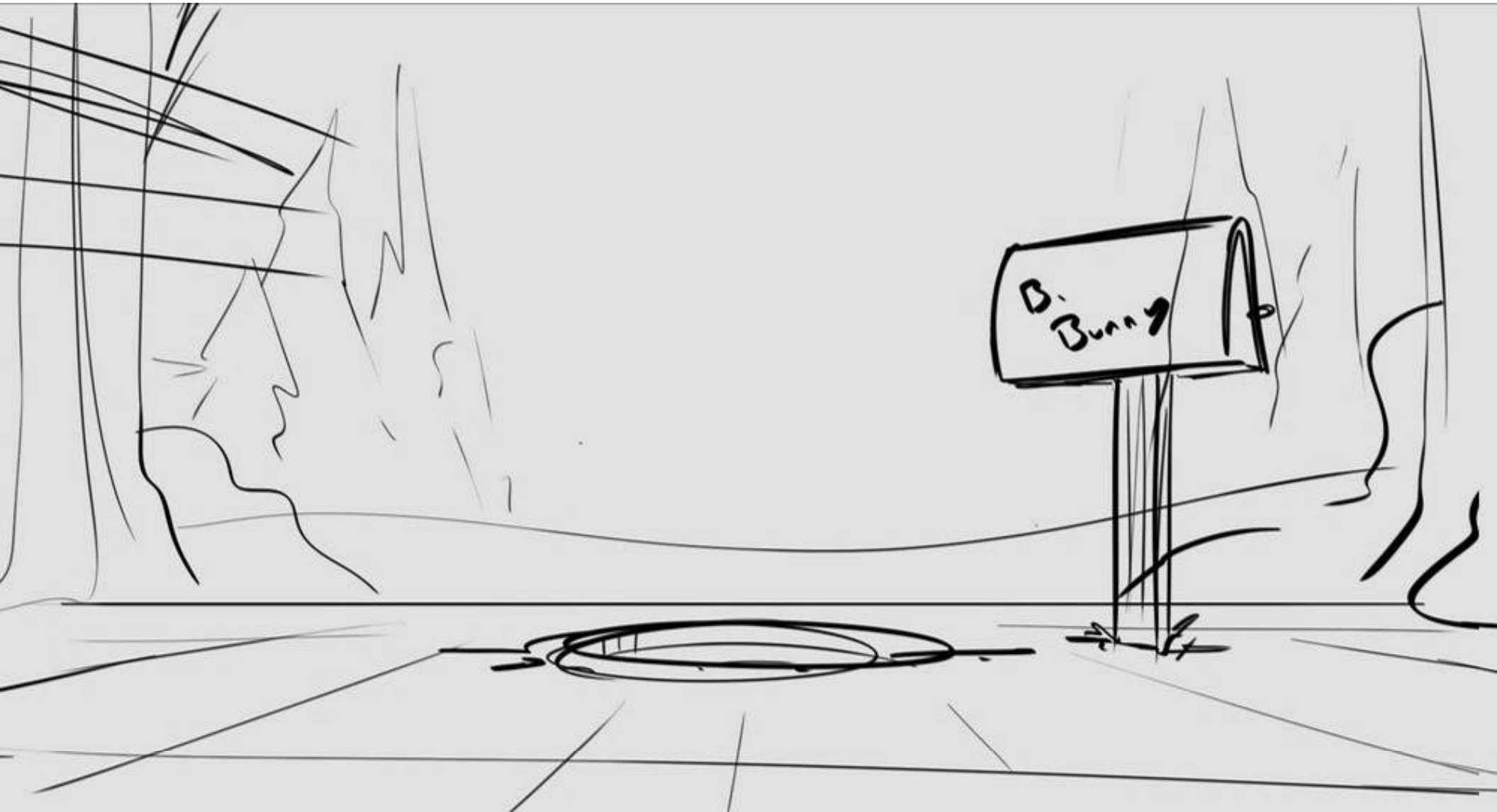

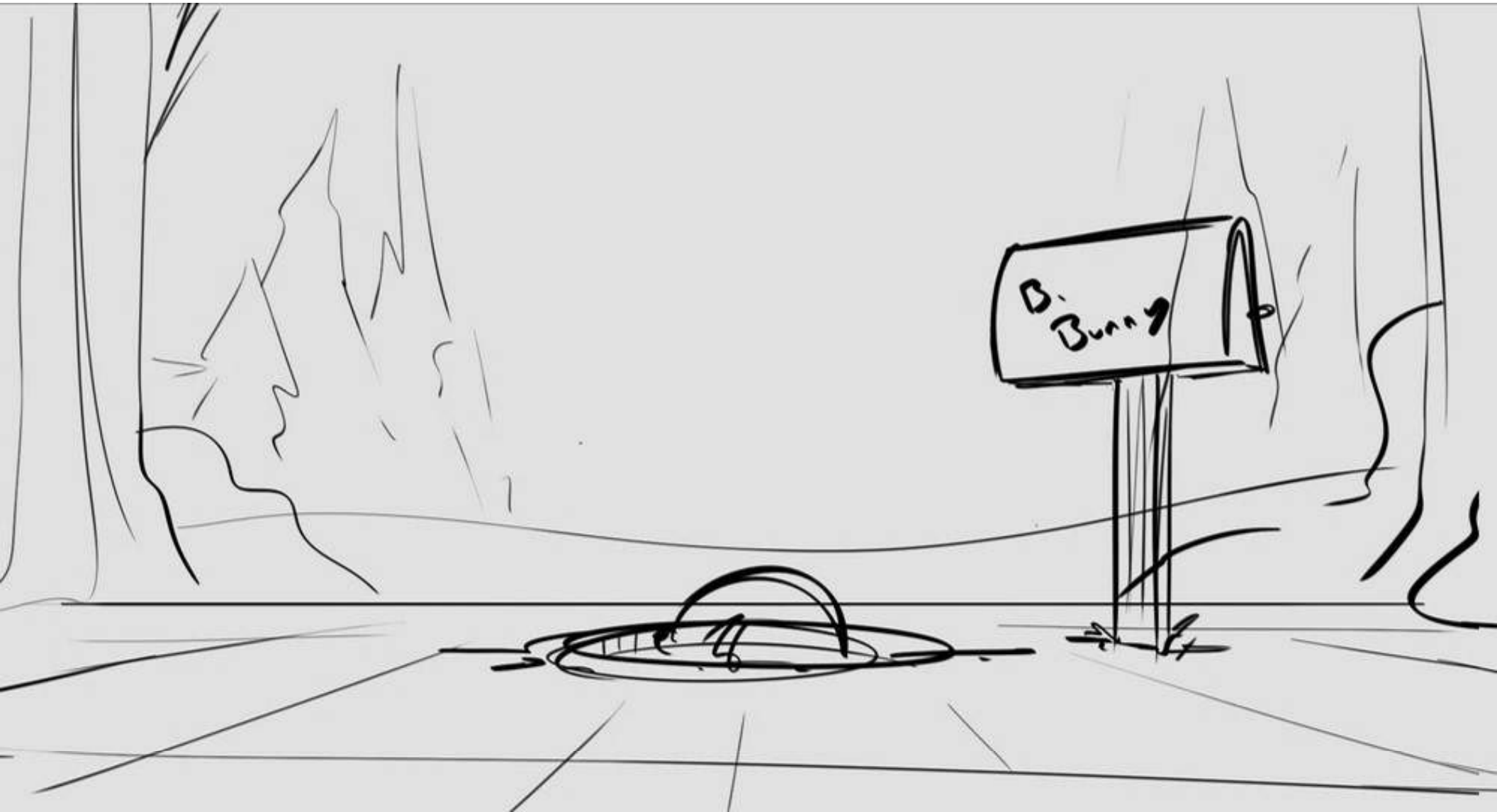





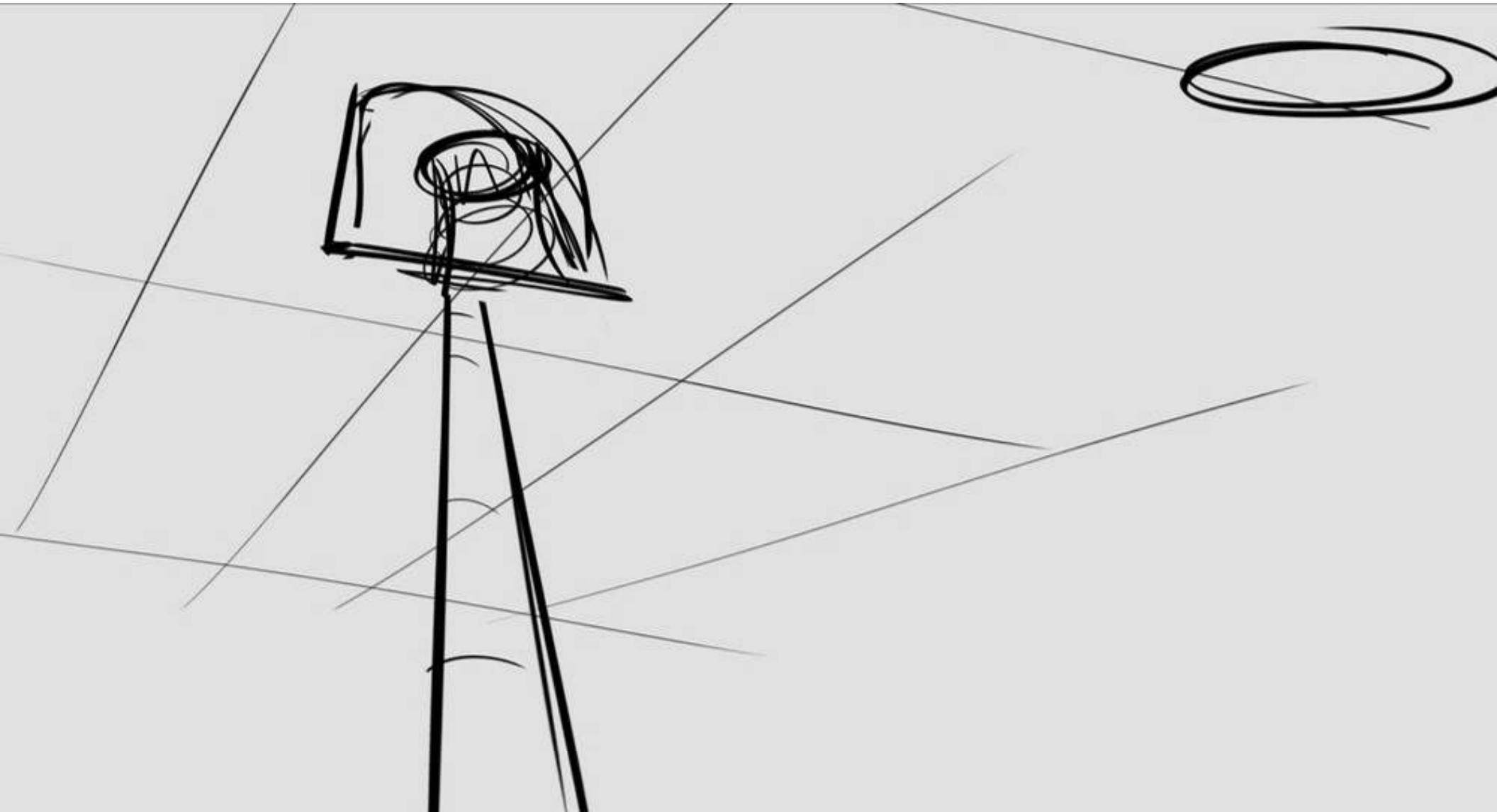





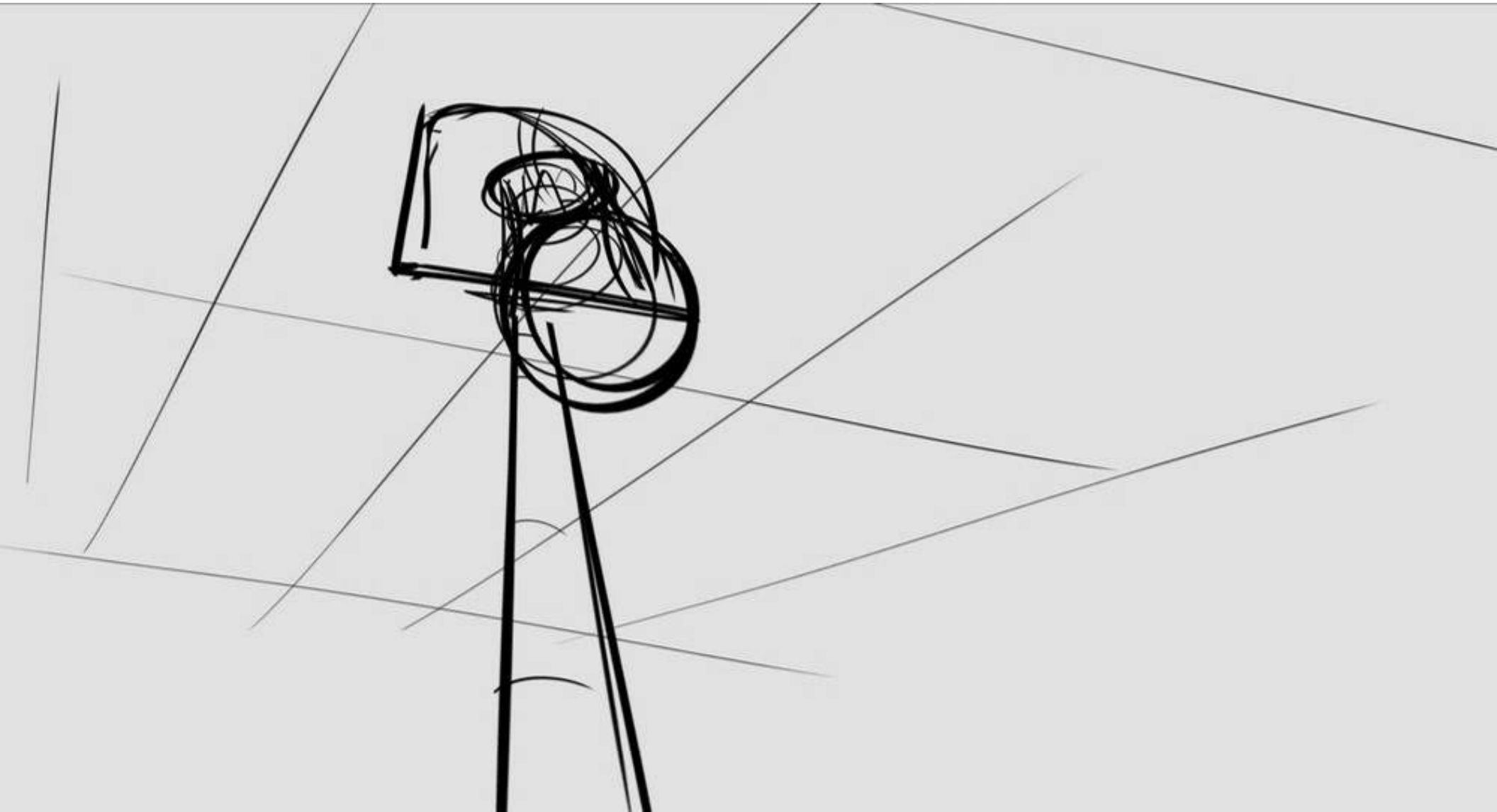

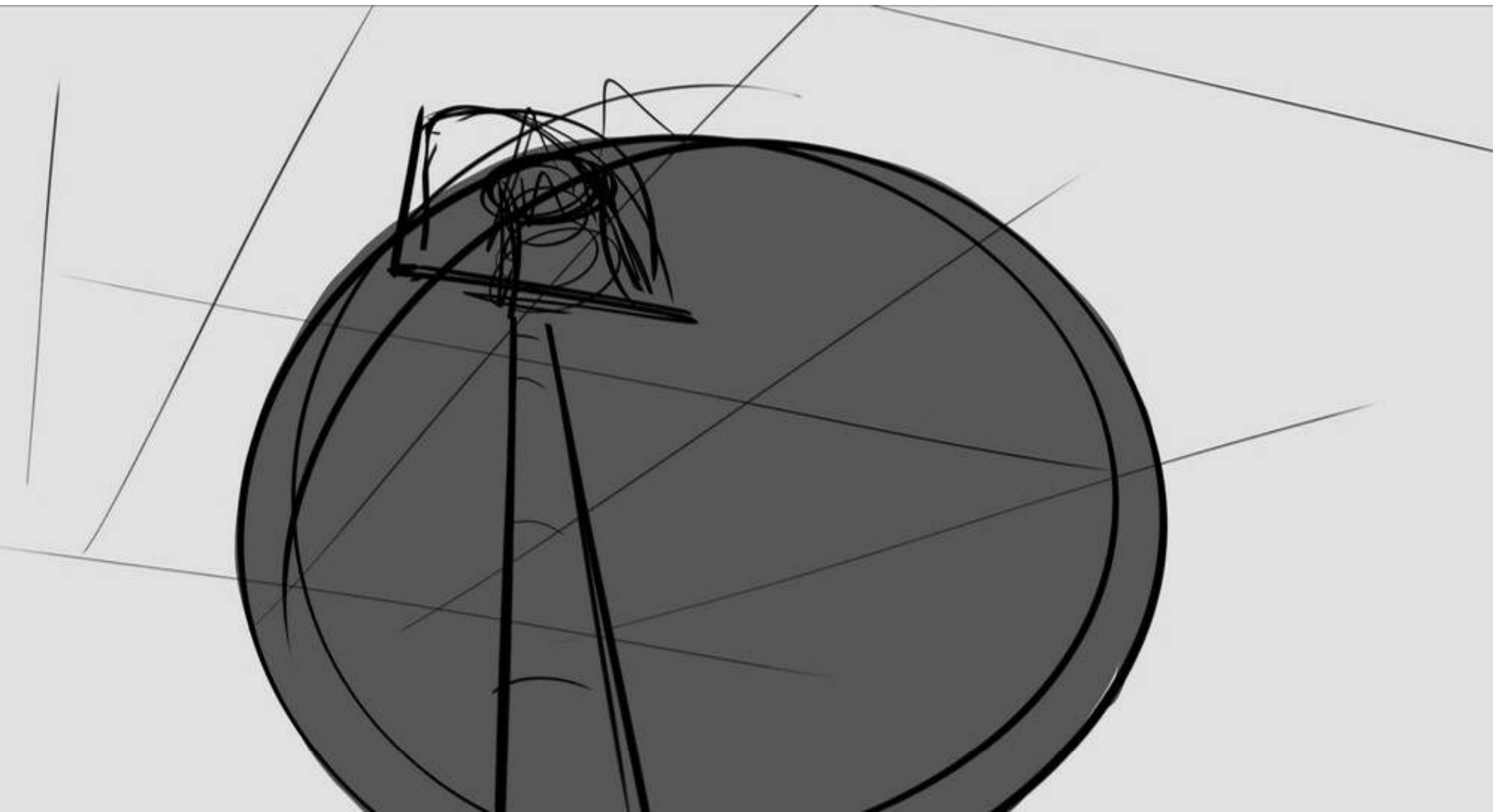

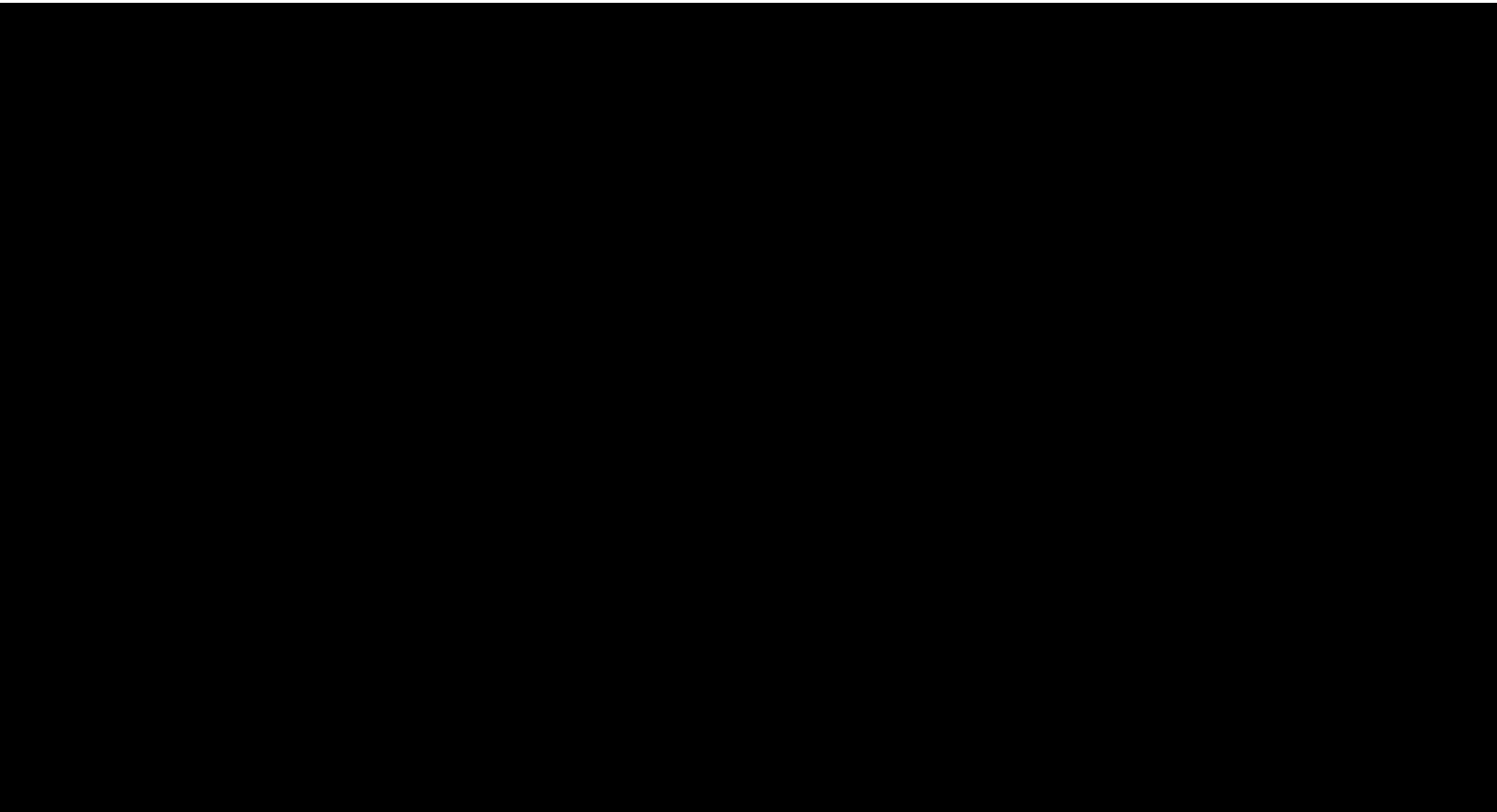

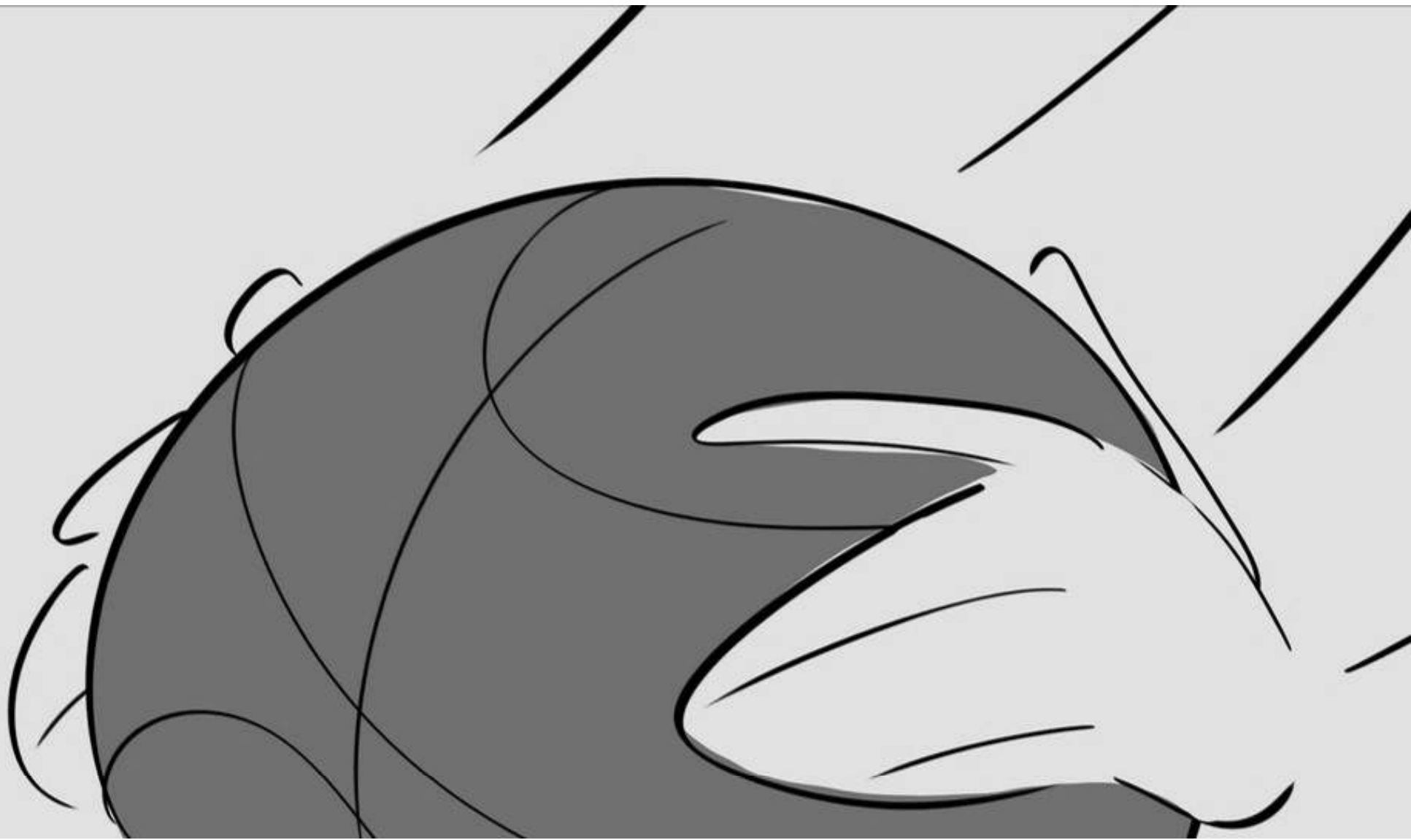

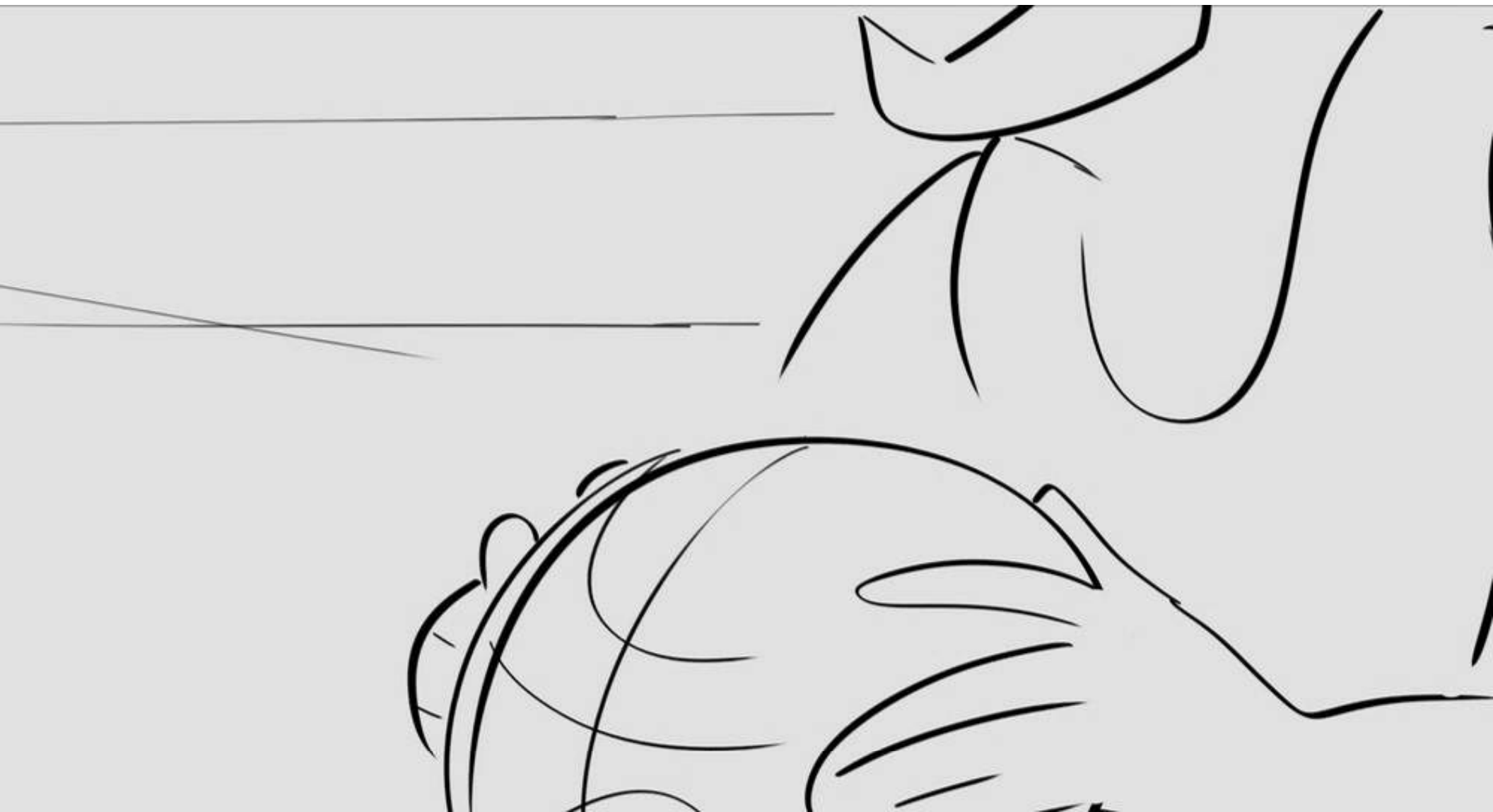



LEBRON: I hear you, Lola B.



LEBRON: I hear you, Lola B.



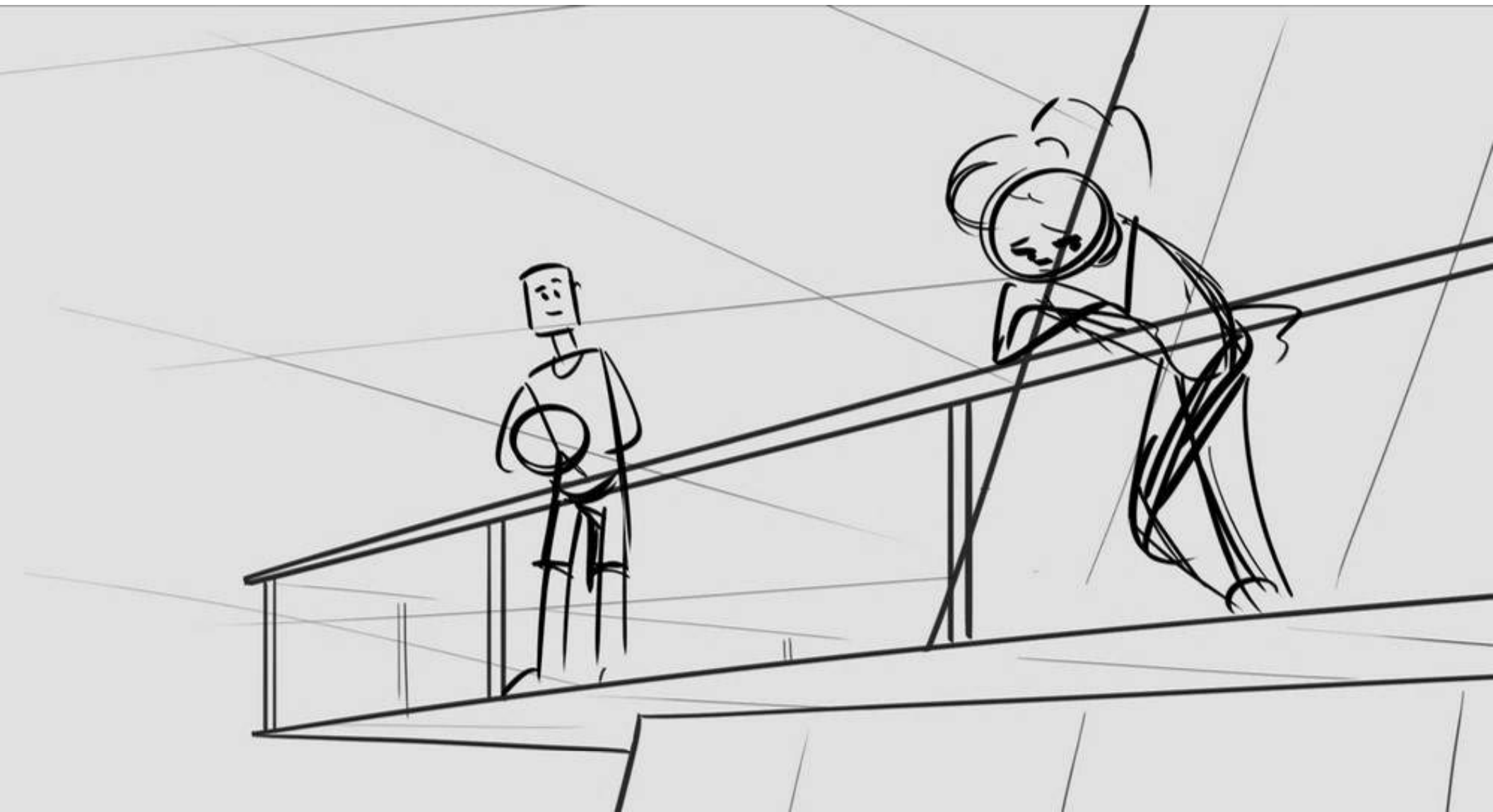

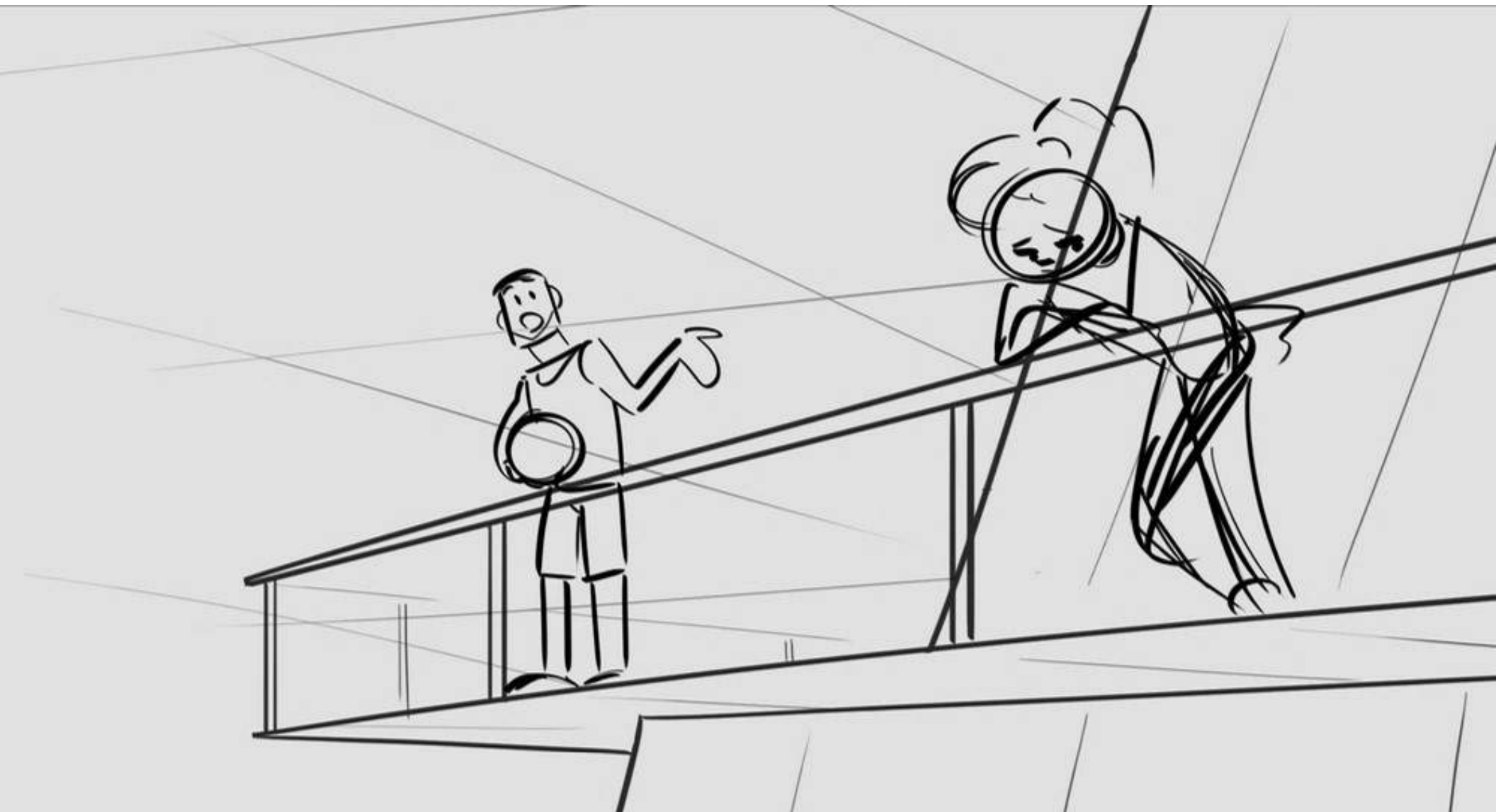

LEBRON: Change can be good.

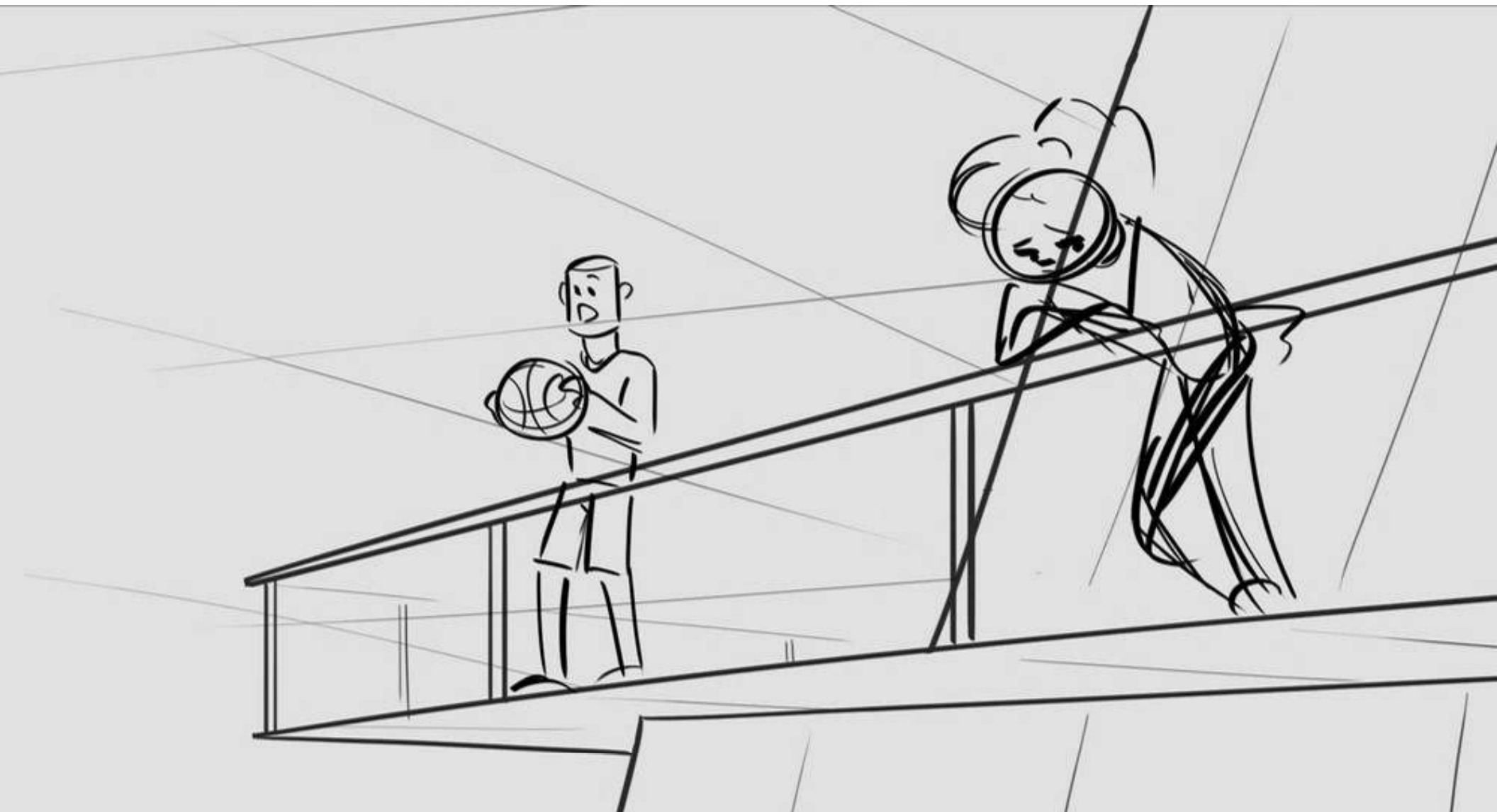

LEBRON: Gets boring when all your championship rings have the same team logo on them.















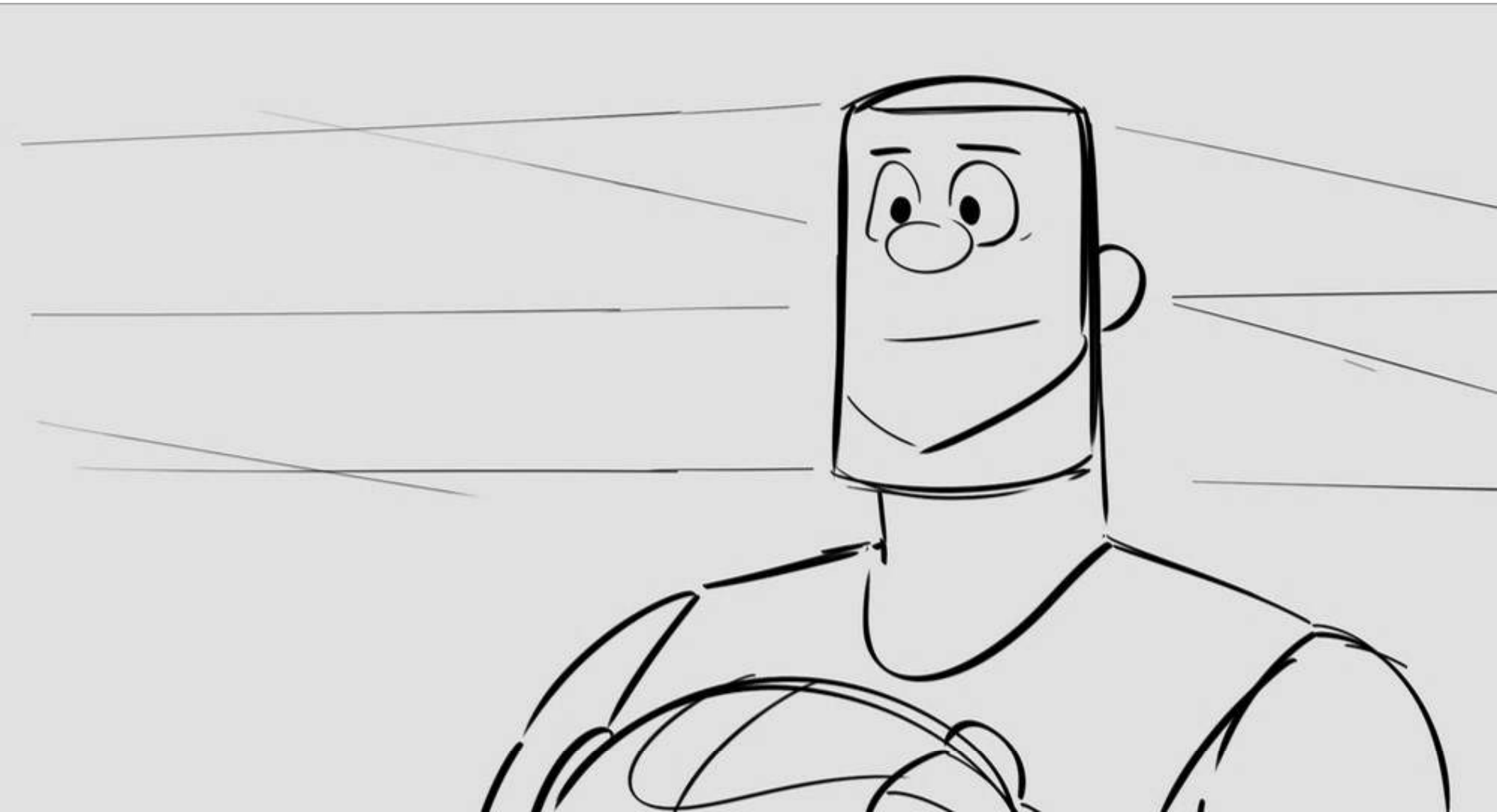

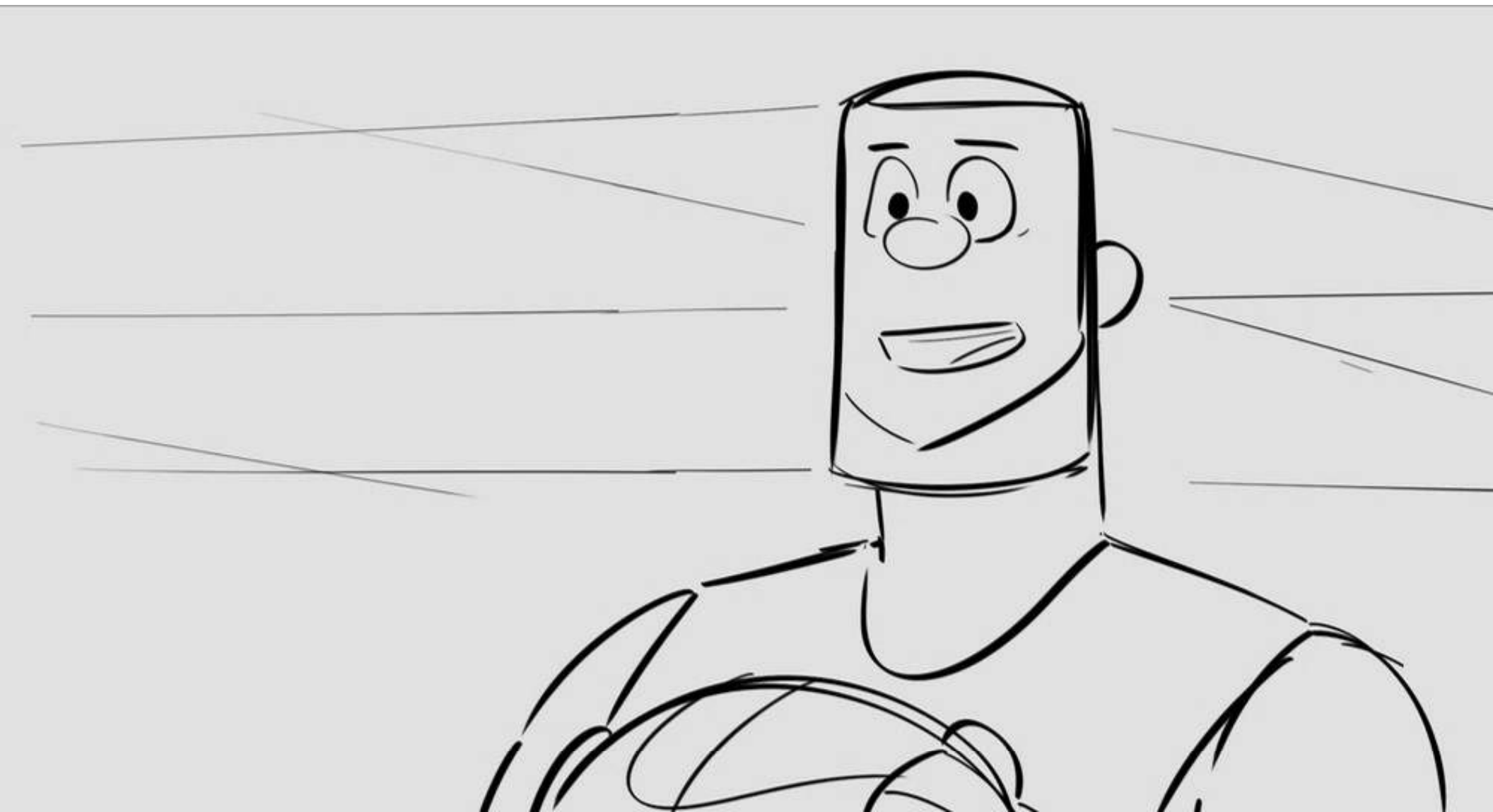

LEBRON: Straight shot,

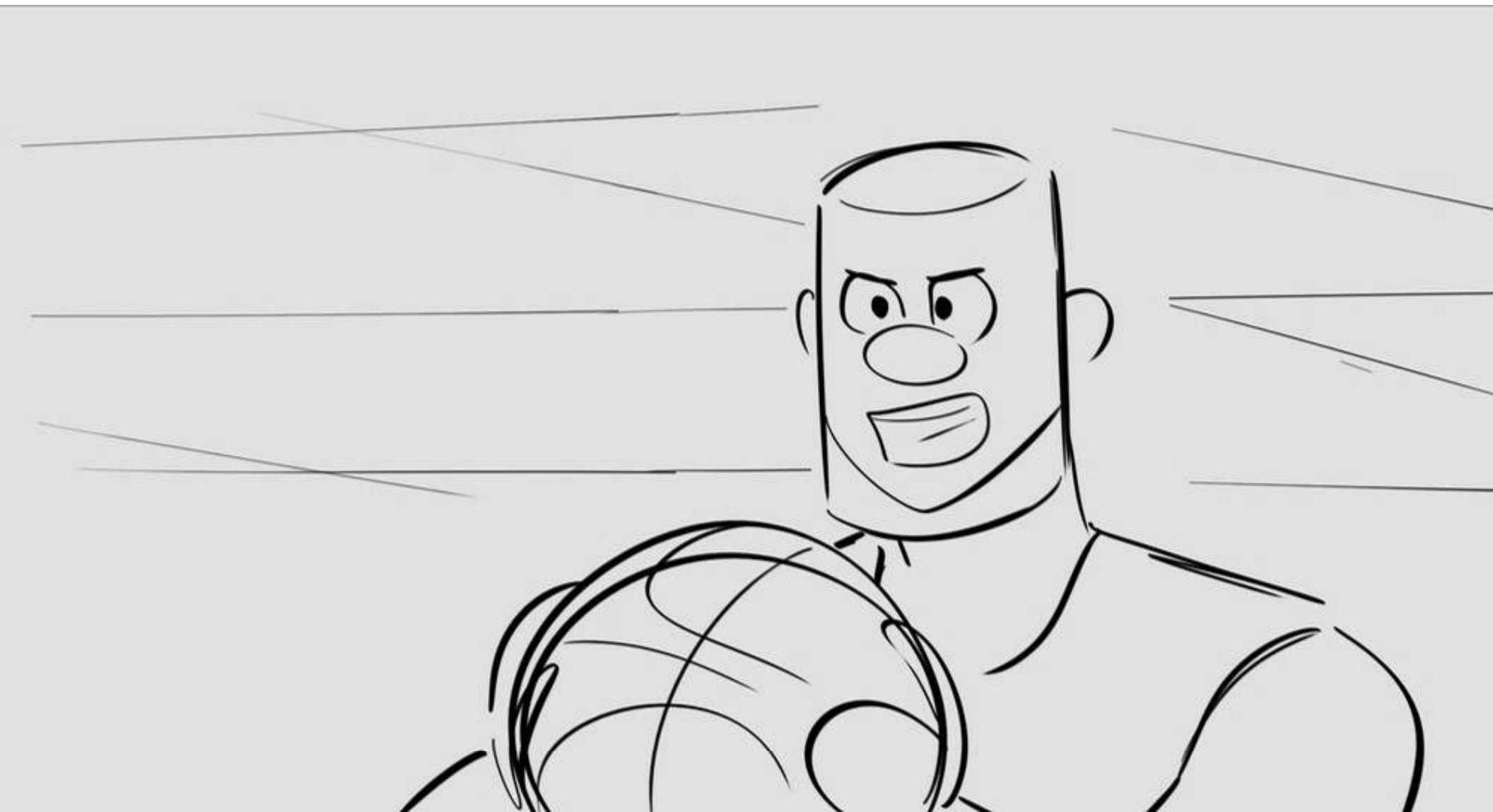

LEBRON: nothing but net.

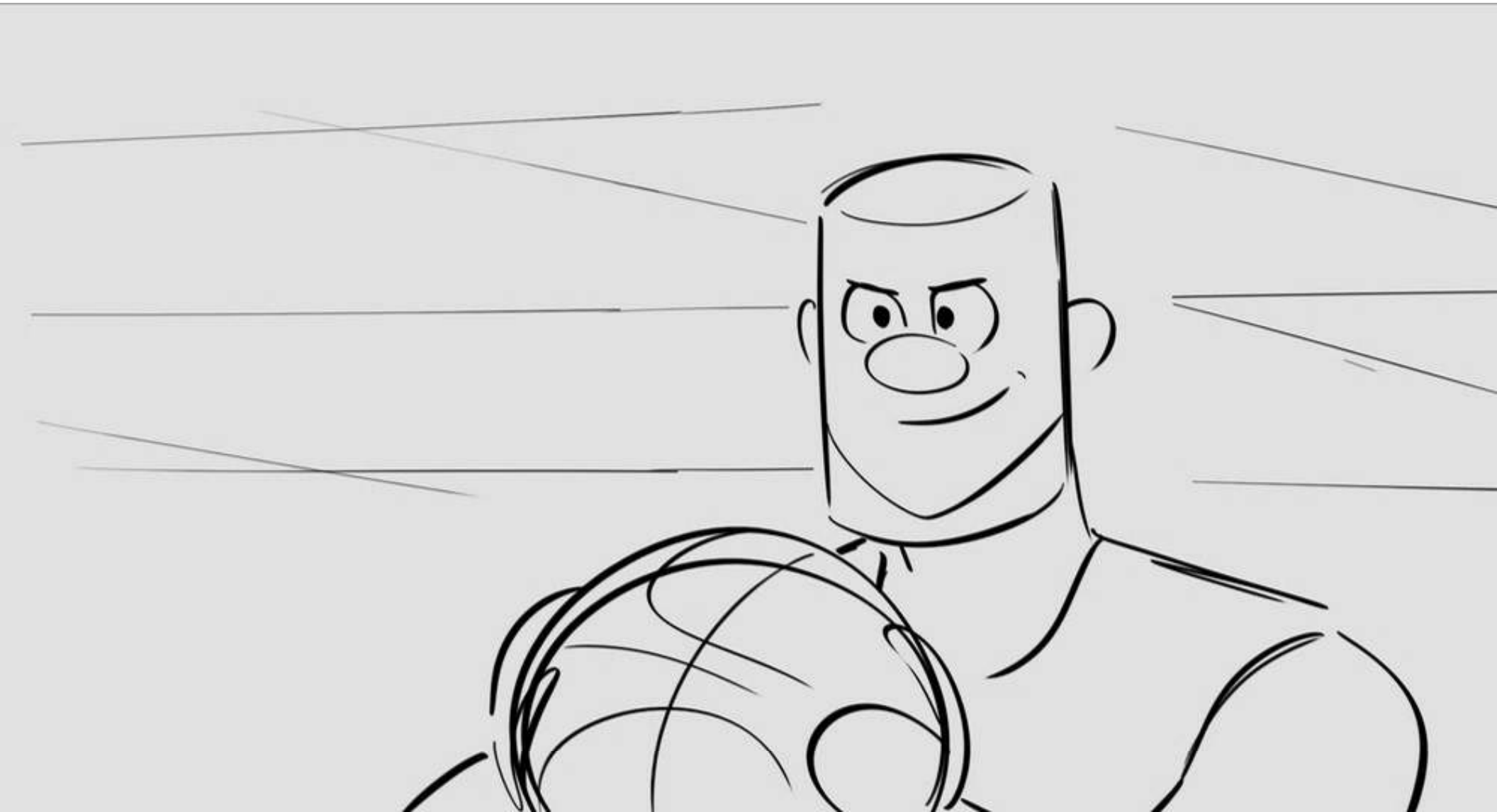



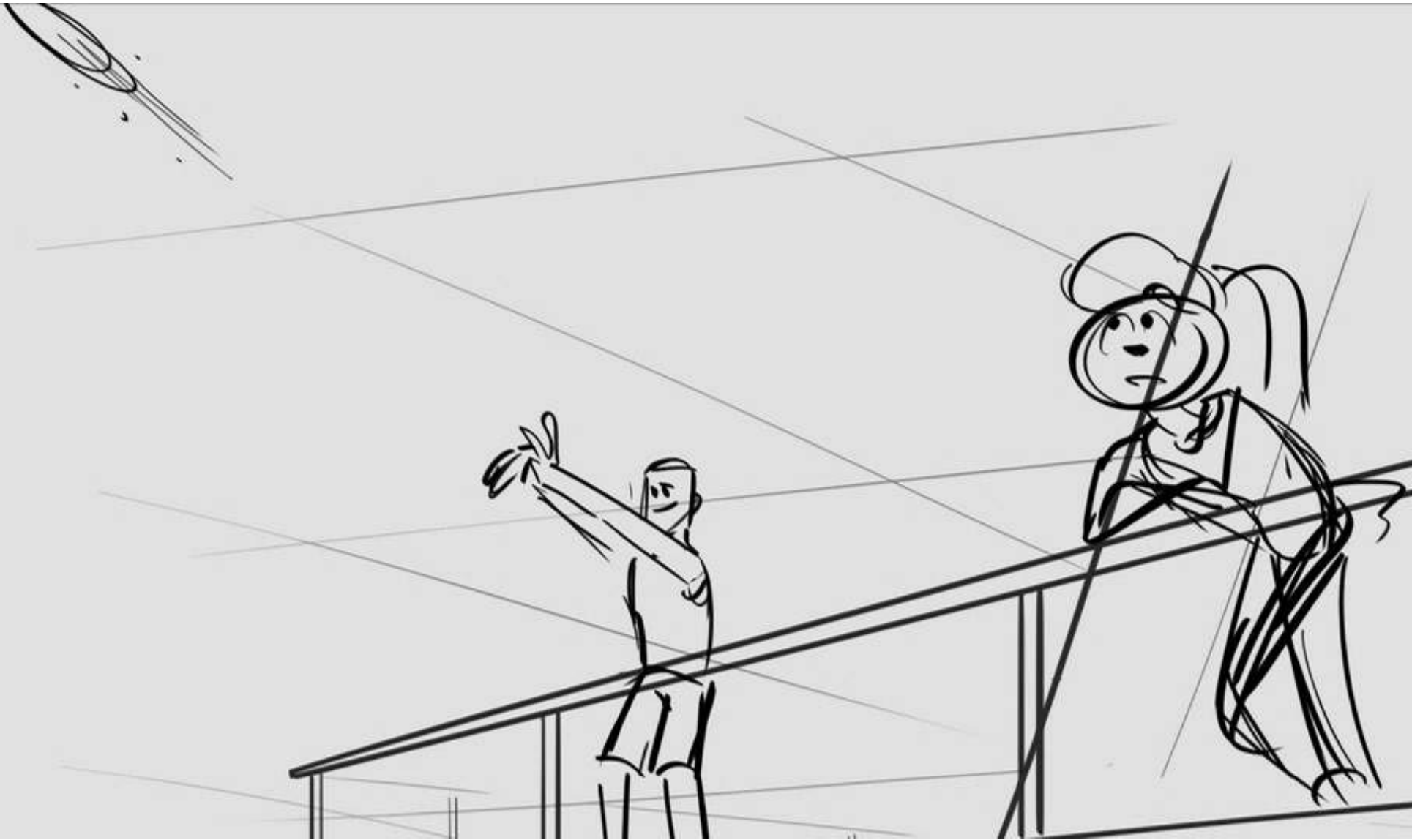

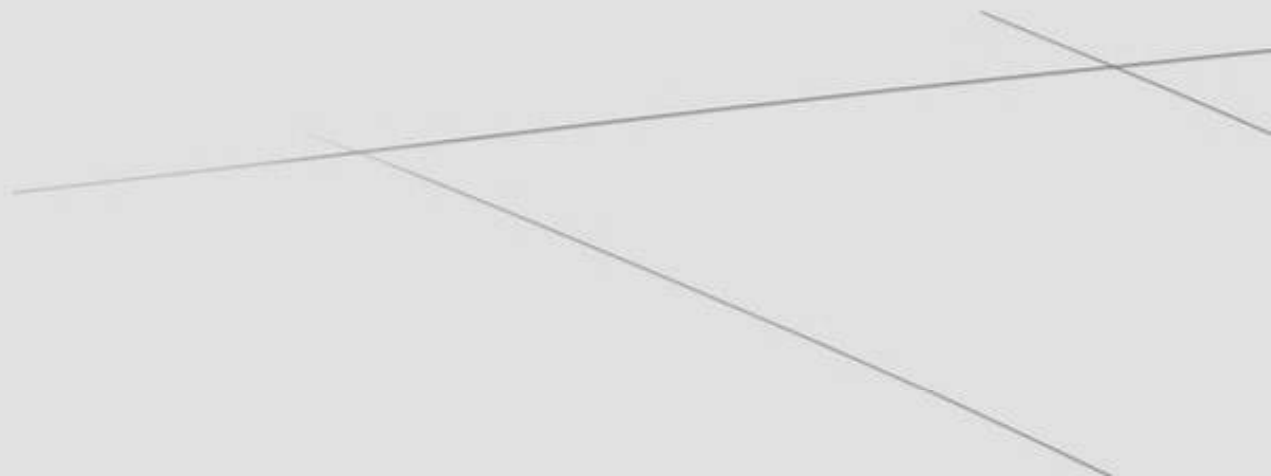



0

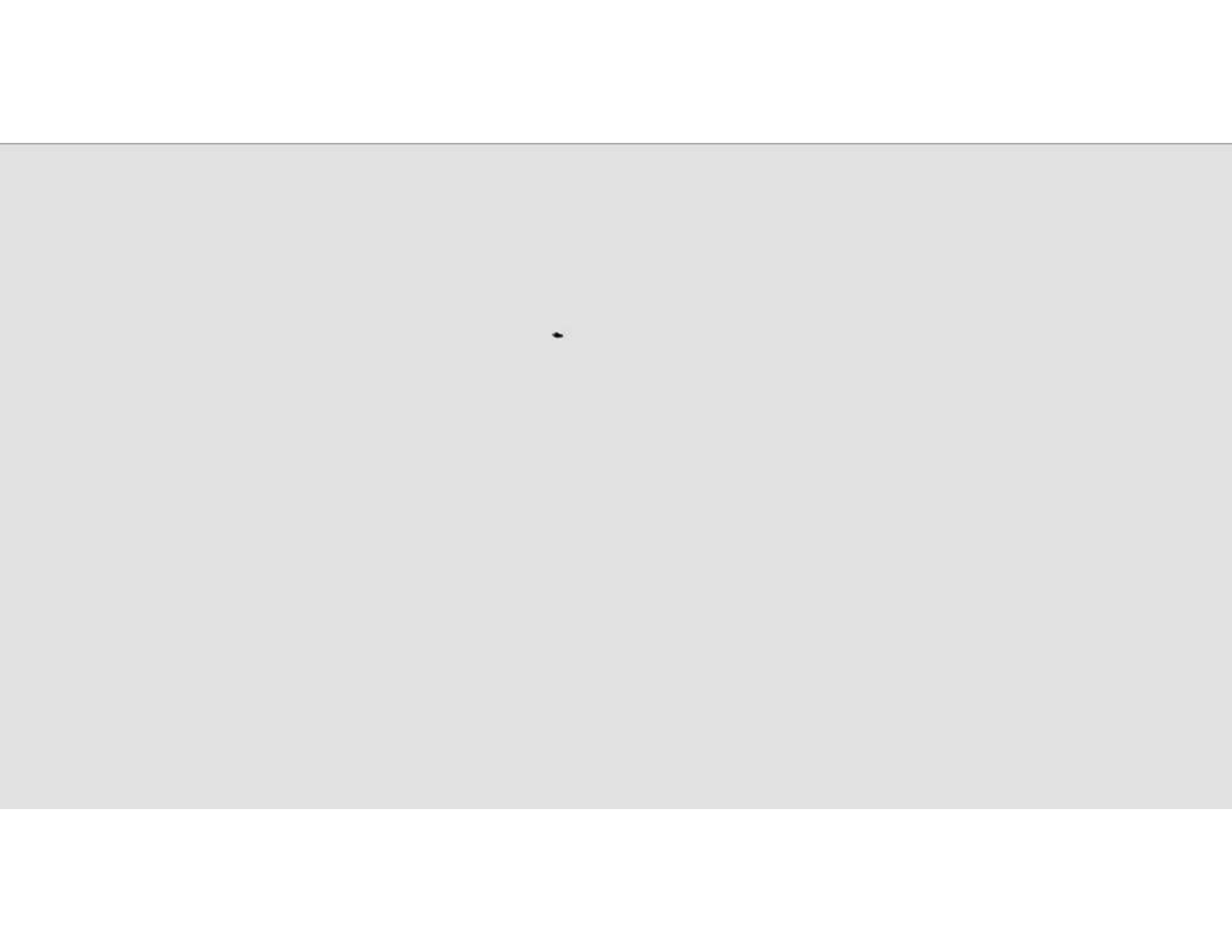

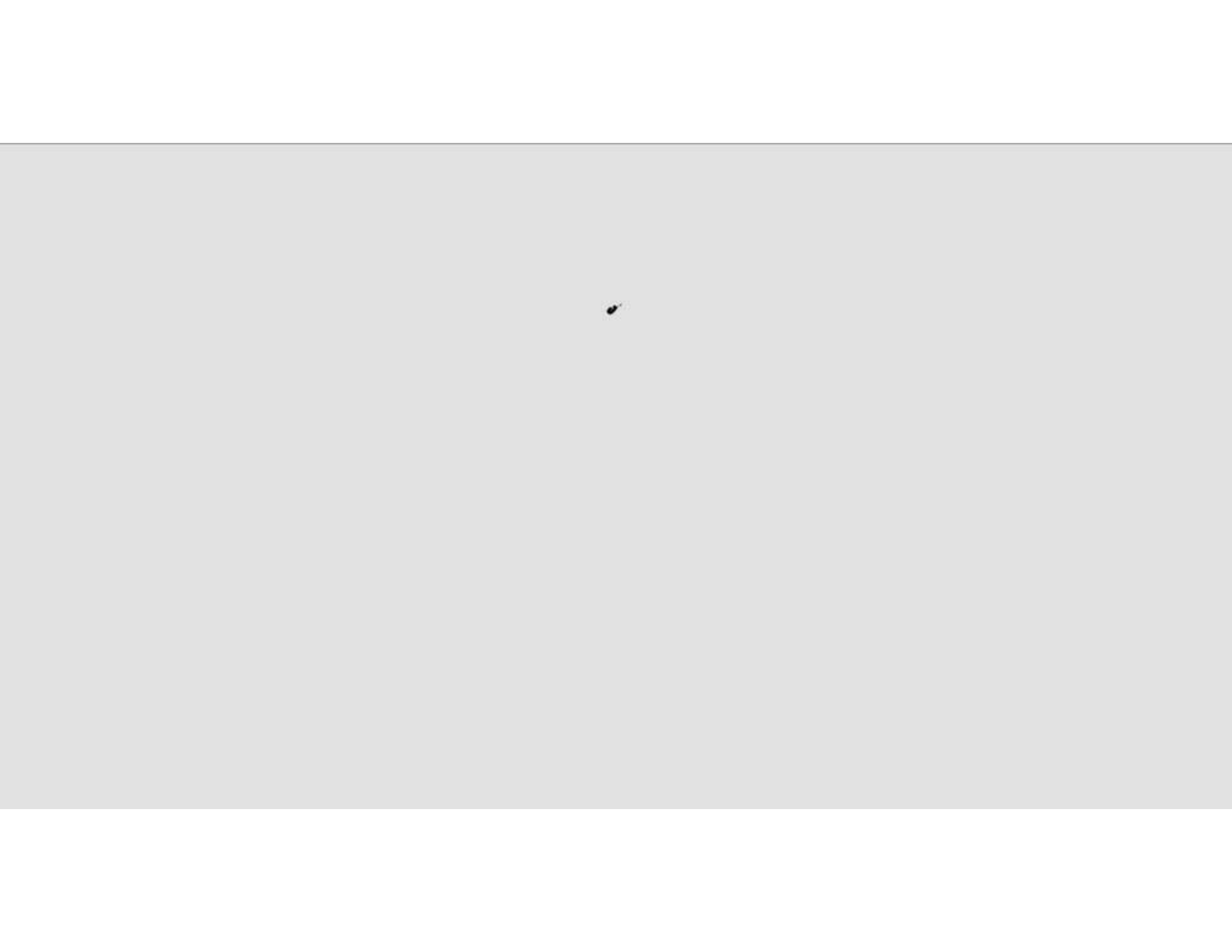





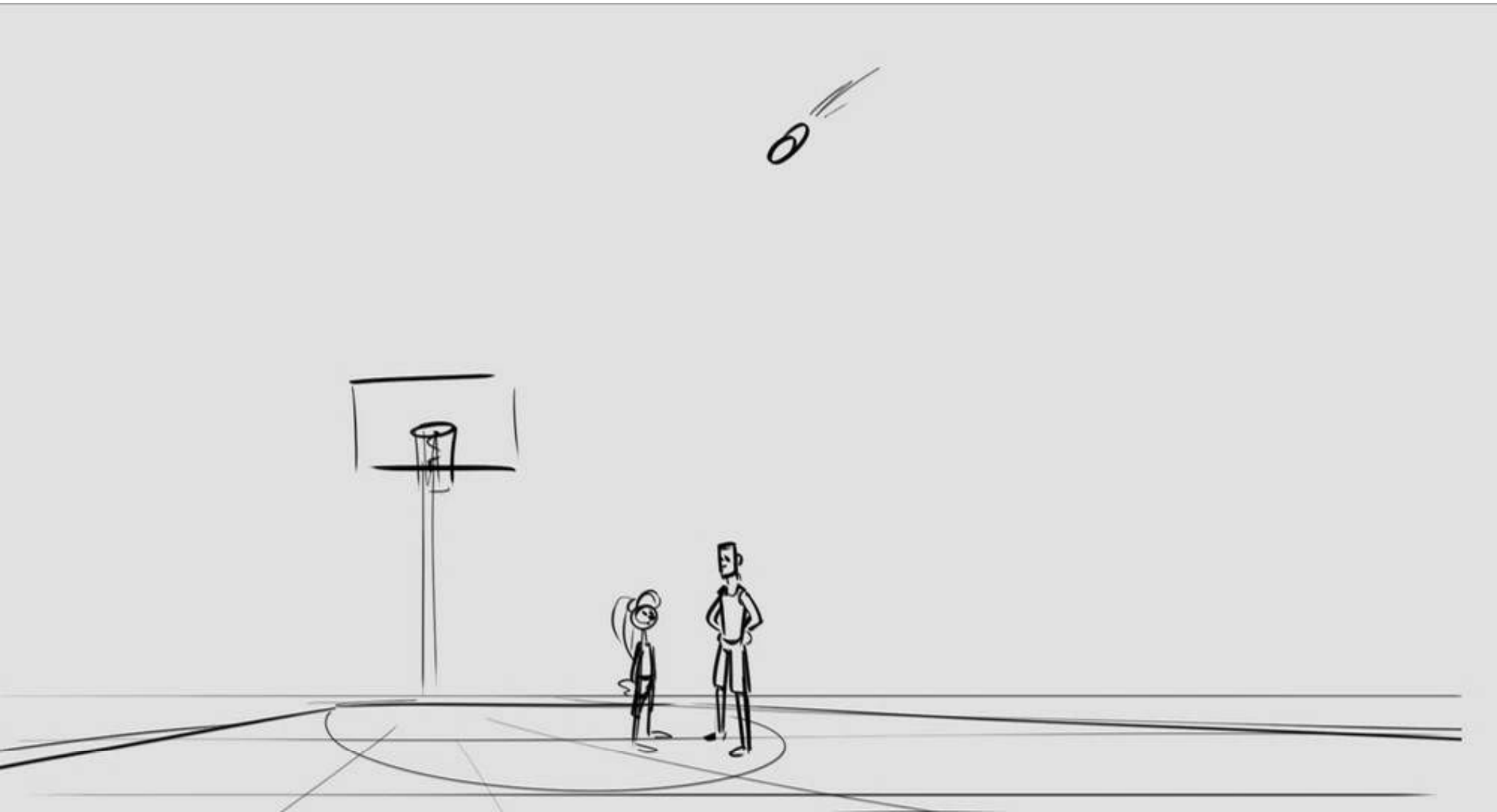

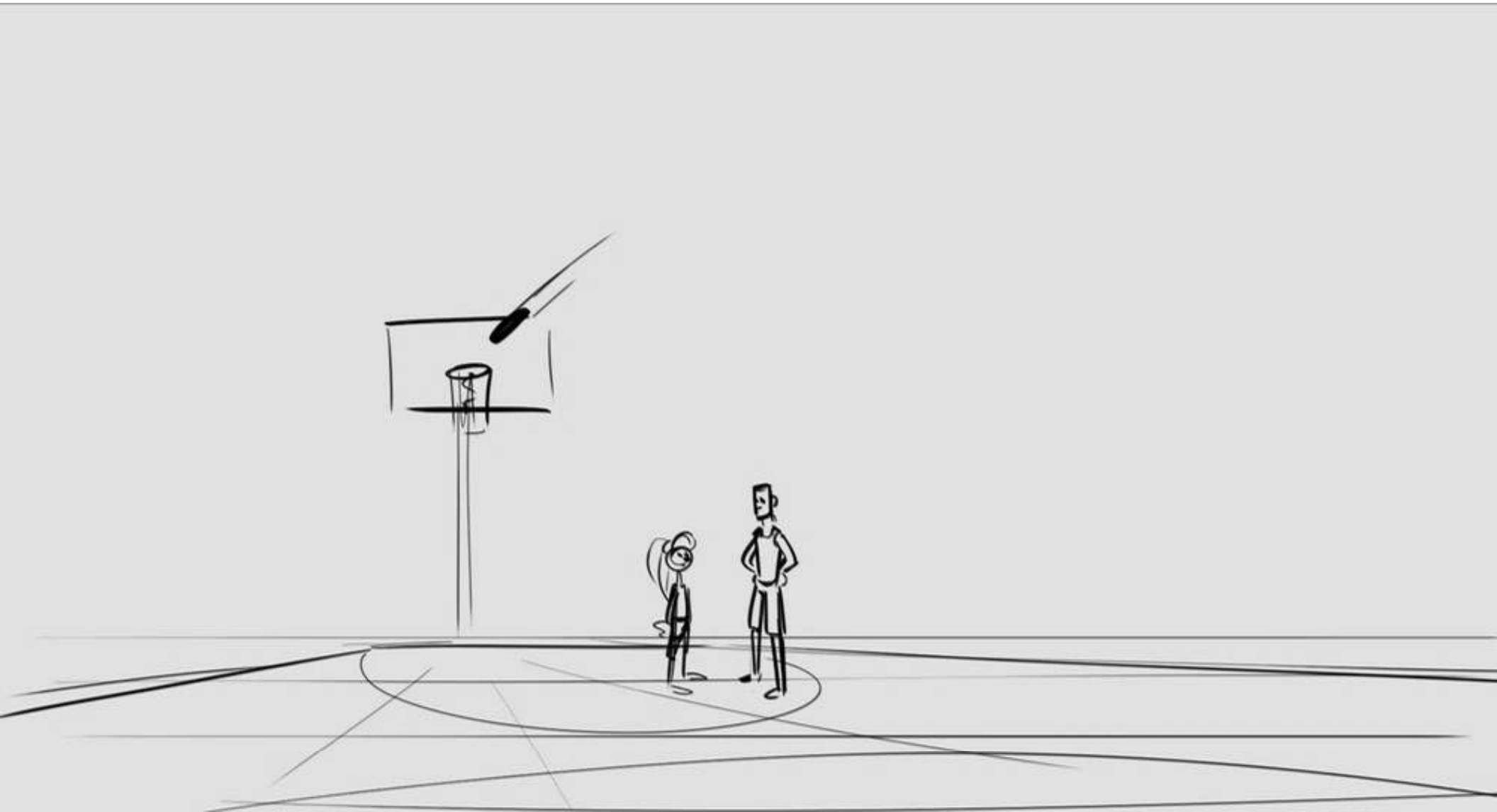



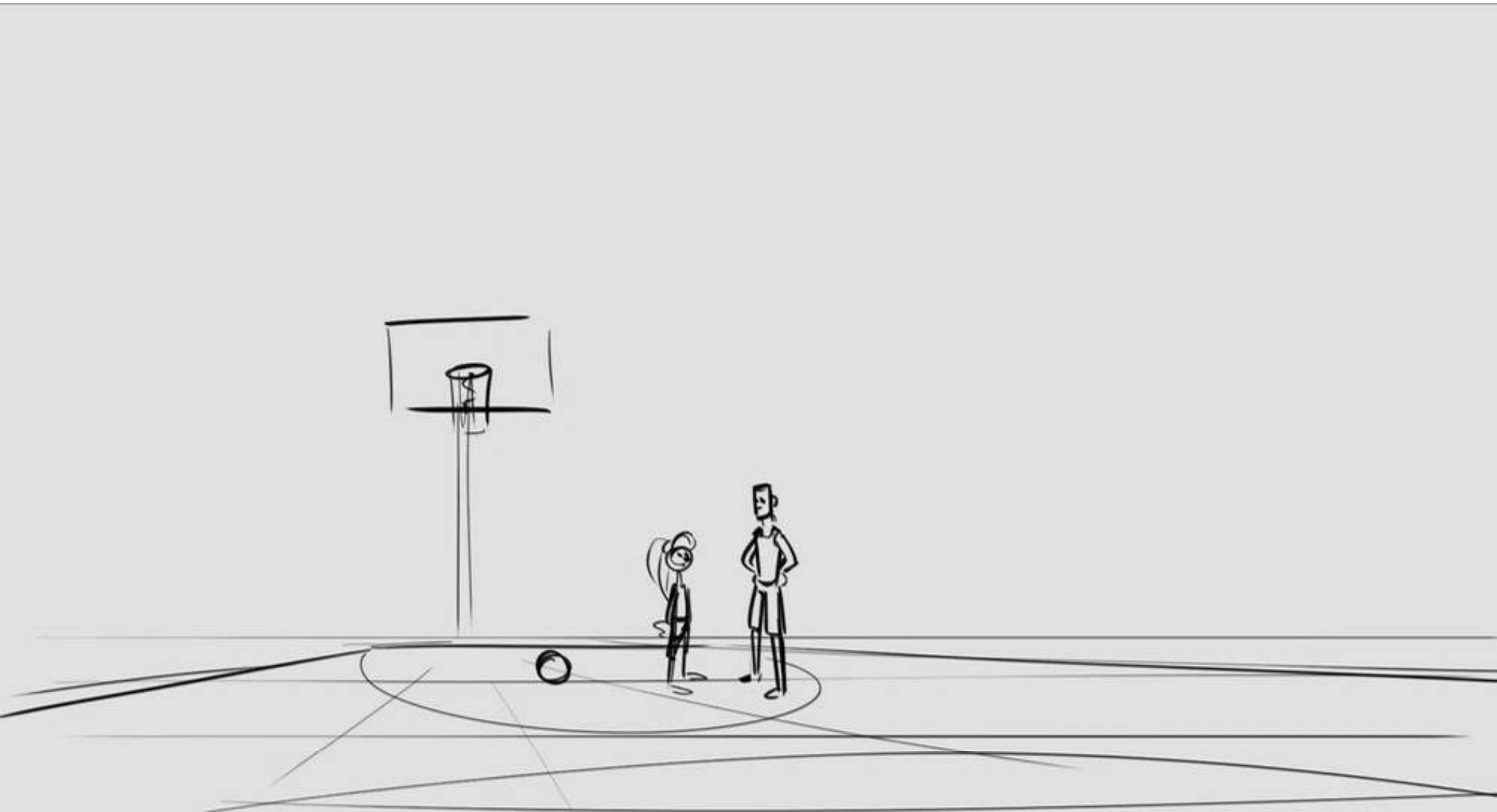



LOLA: Bugs hates change. Even the good kind.







LEBRON: Well like it or hate it, he's gonna have to do it. It's the only way.



LEBRON: When people are relying on you, there's no choice but to step up.

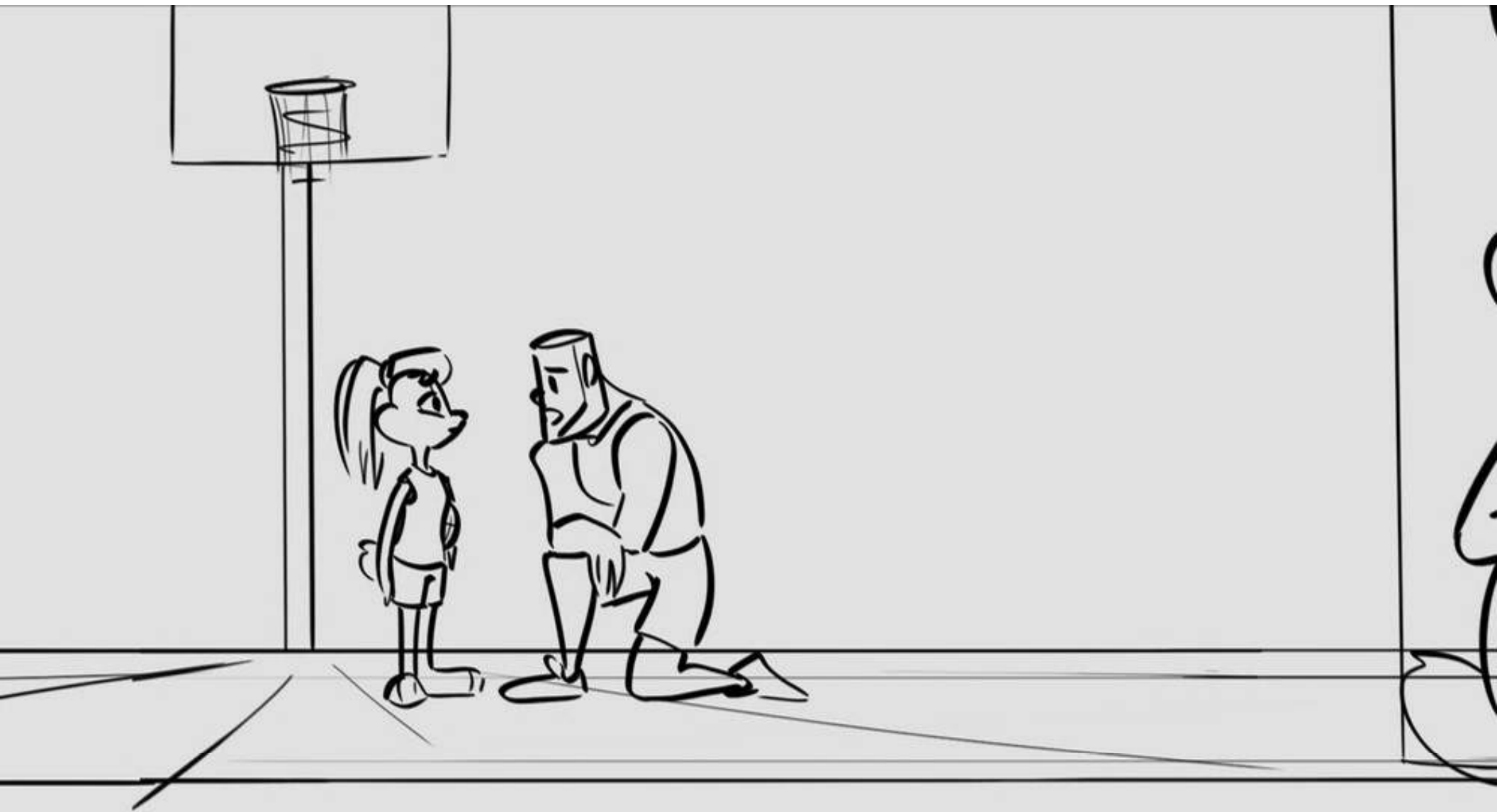

LEBRON: When people are relying on you, there's no choice but to step up.



LEBRON: When people are relying on you, there's no choice but to step up.



LEBRON: When people are relying on you, there's no choice but to step up.



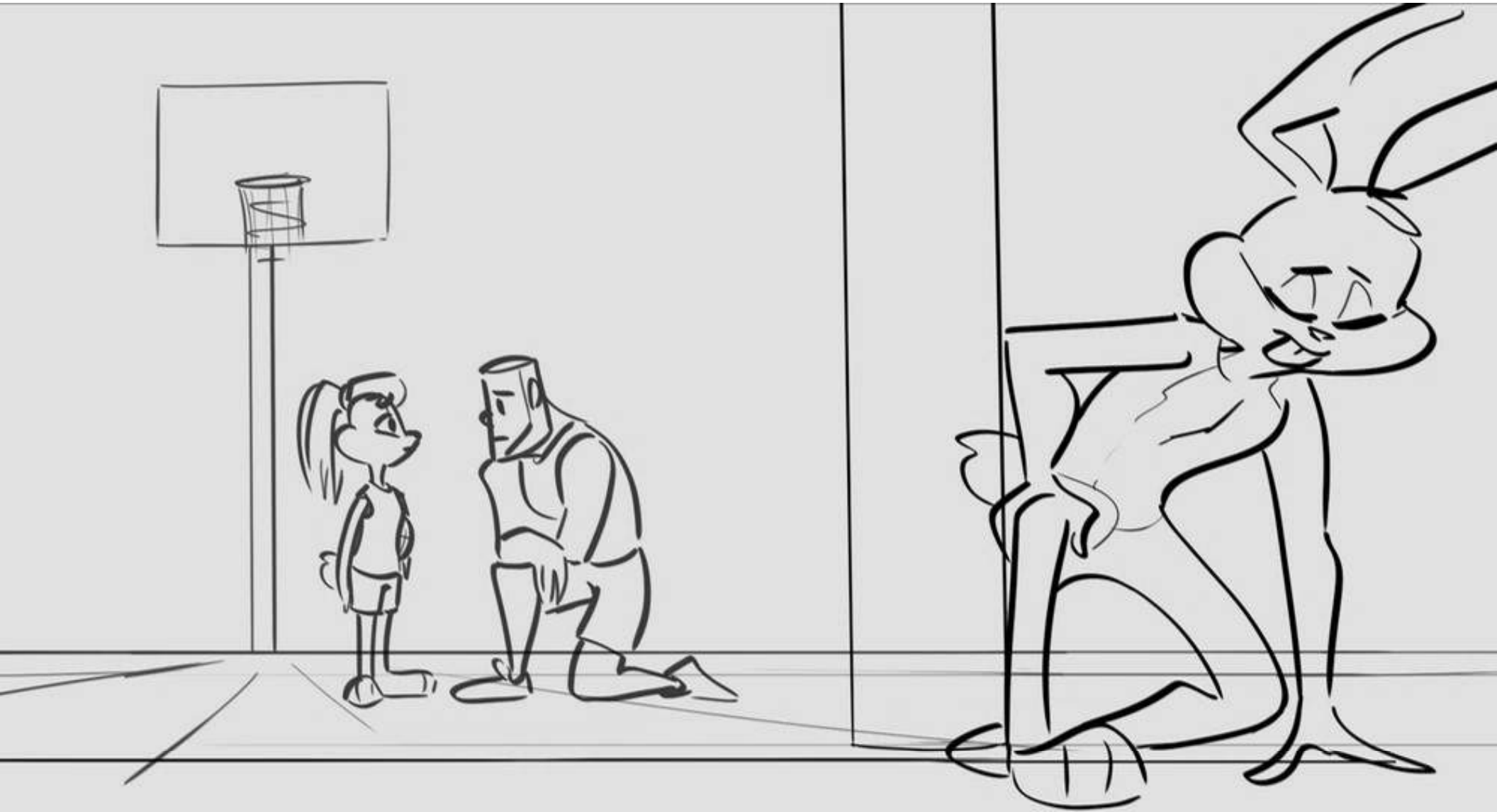



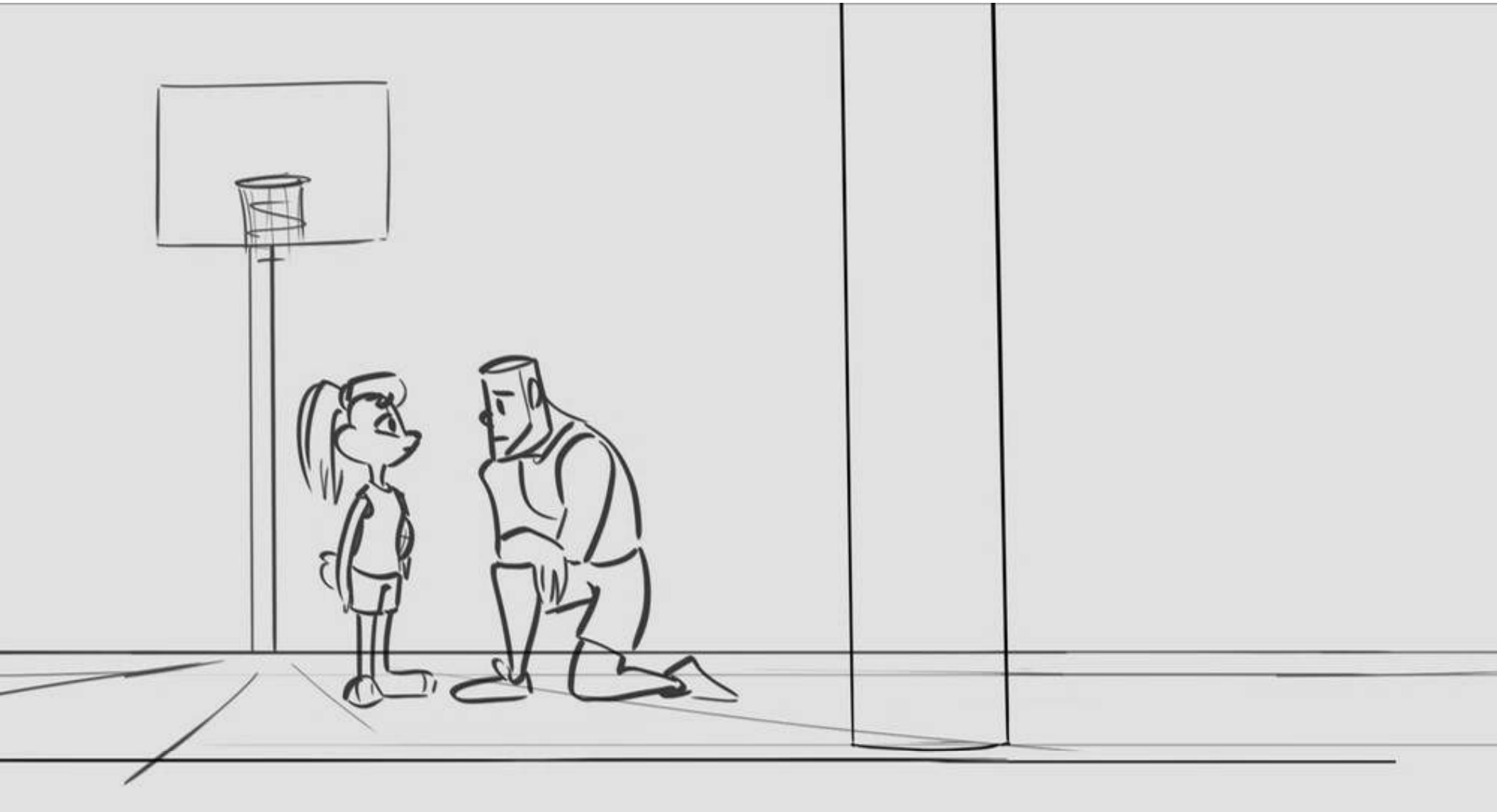





















LOLA: Off the gutter,

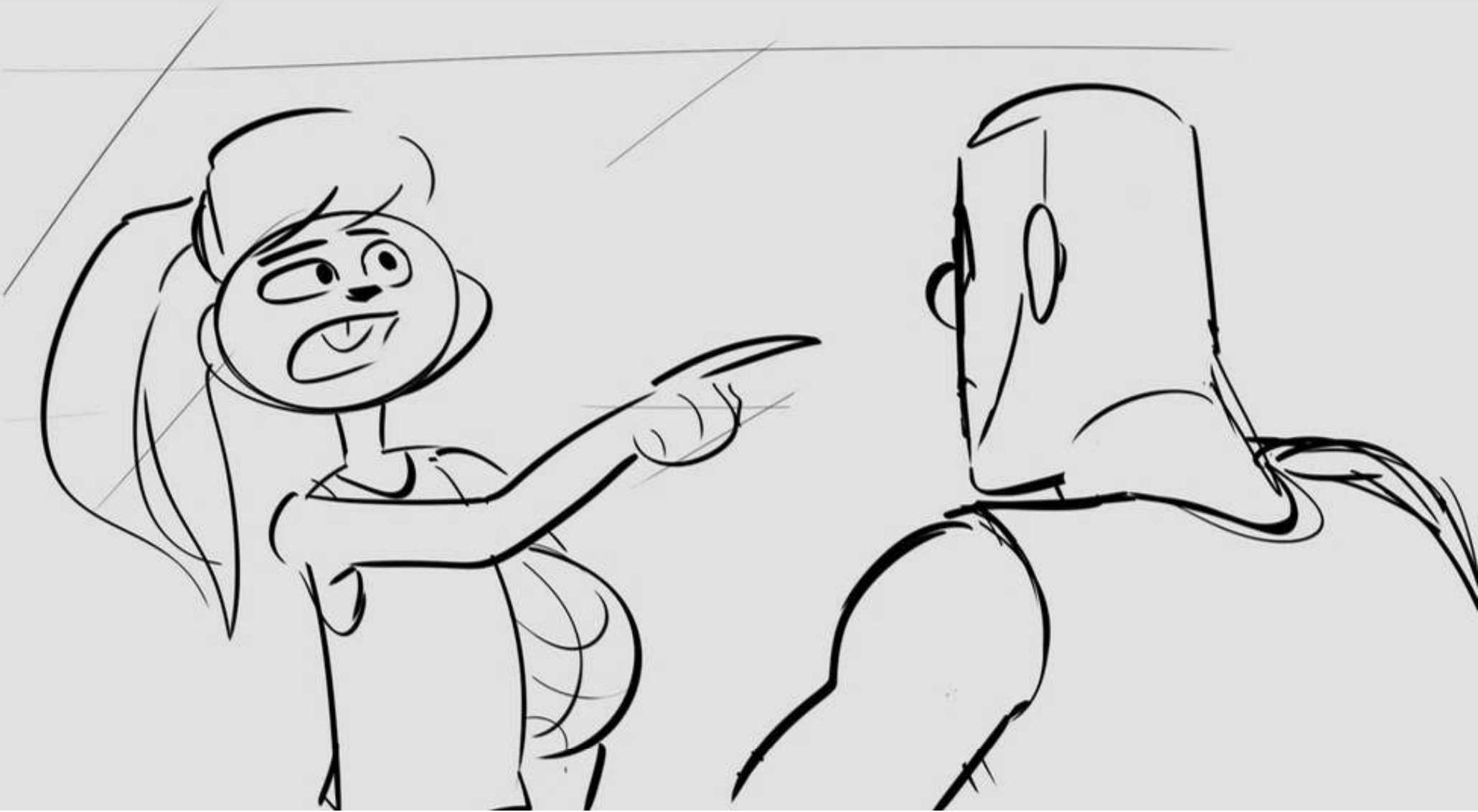

LOLA: Off the gutter,



LOLA: around the sombrero,

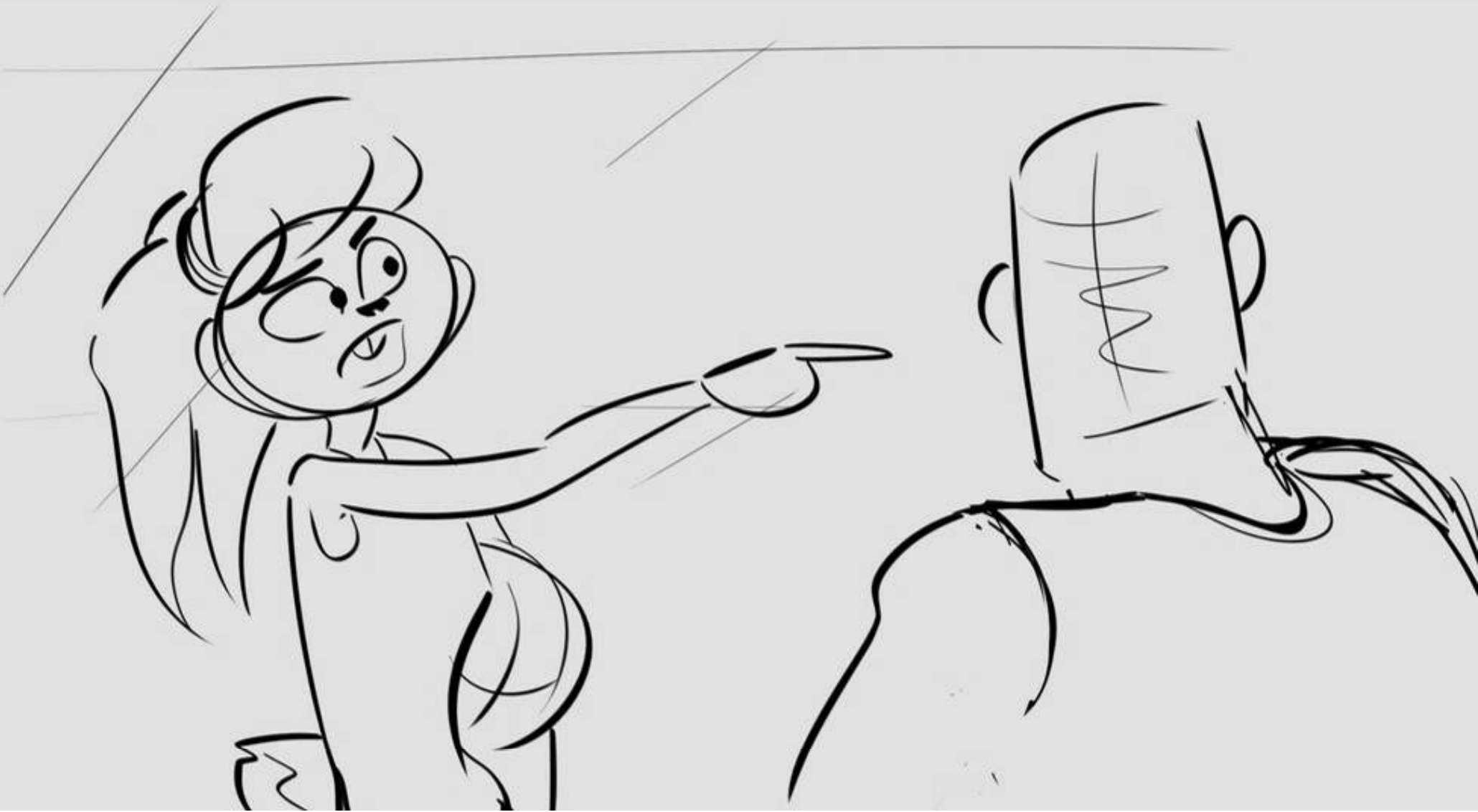

LOLA: off that cliff,

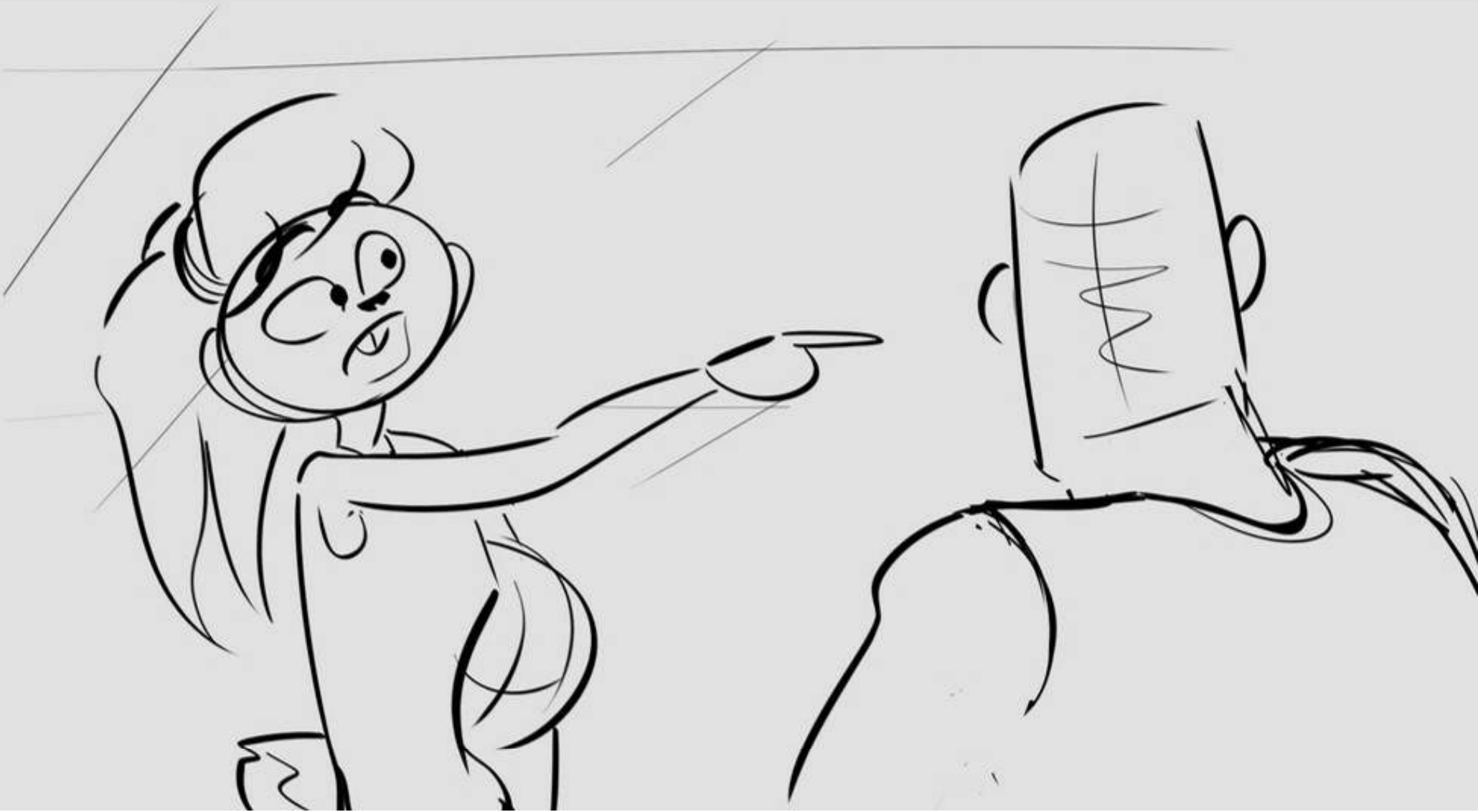

LOLA: off that OTHER cliff,



LOLA: off that OTHER cliff,



LOLA: off the doghouse,

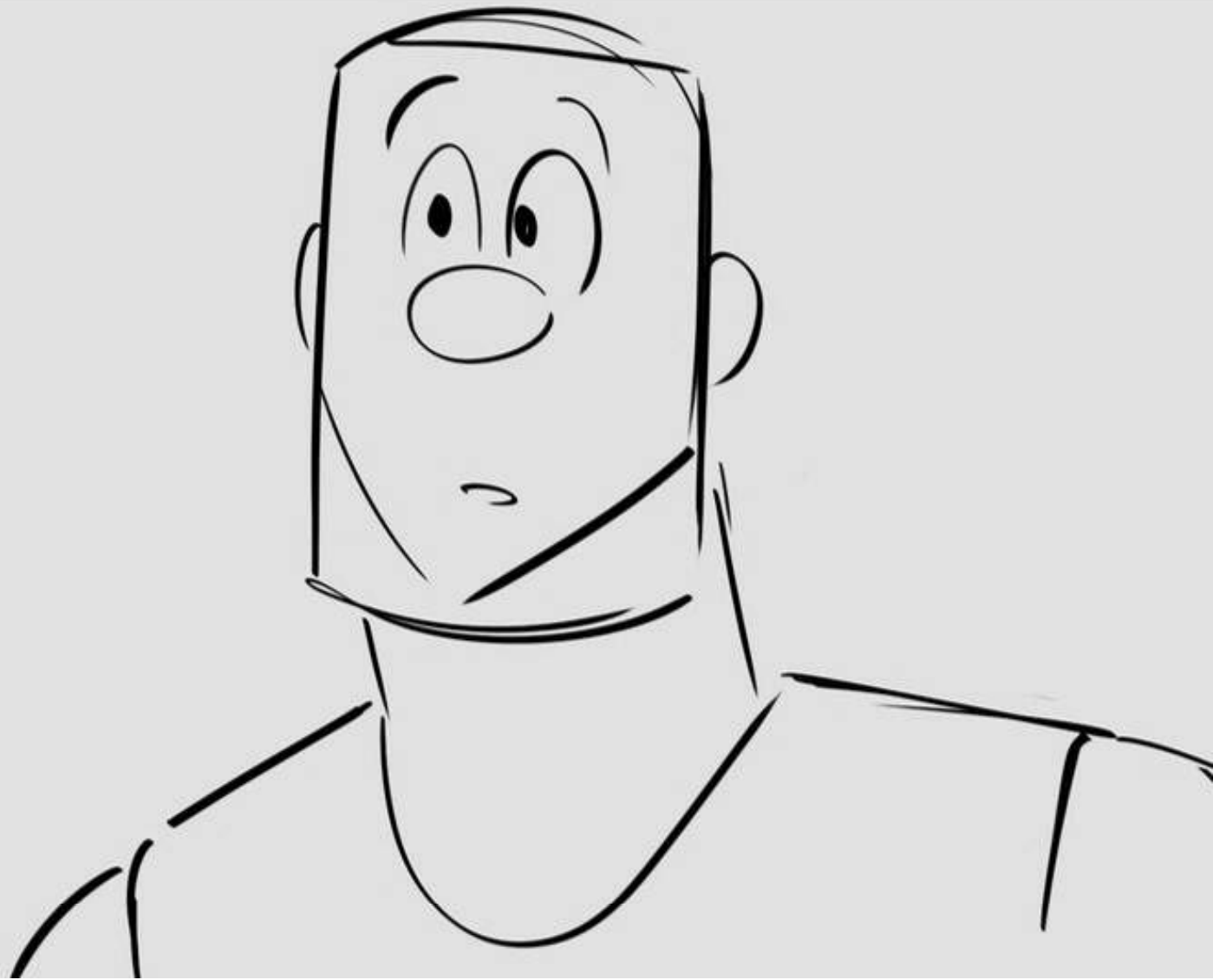

LOLA: through the barn,

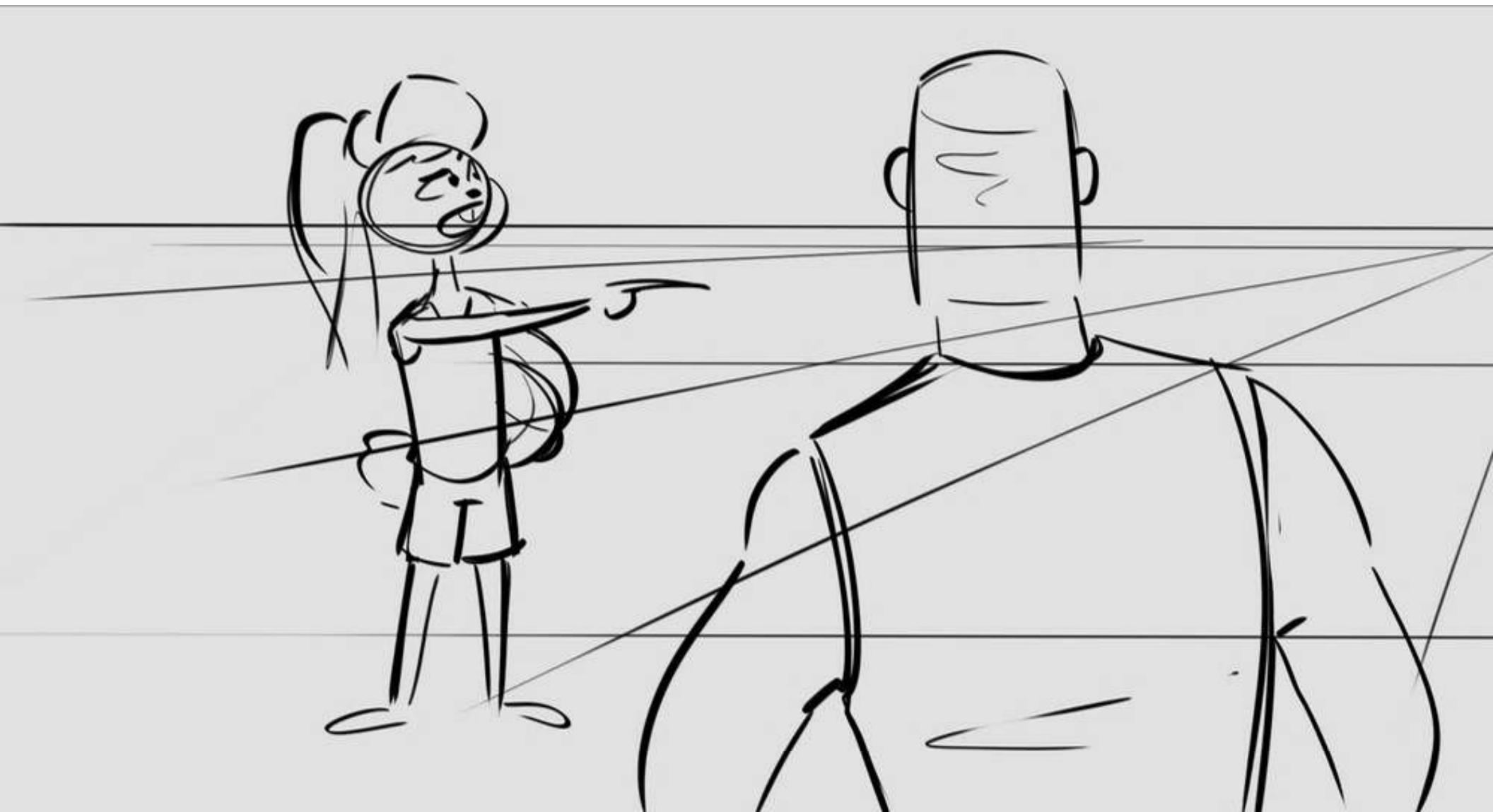

LOLA: off Daffy's updraft,

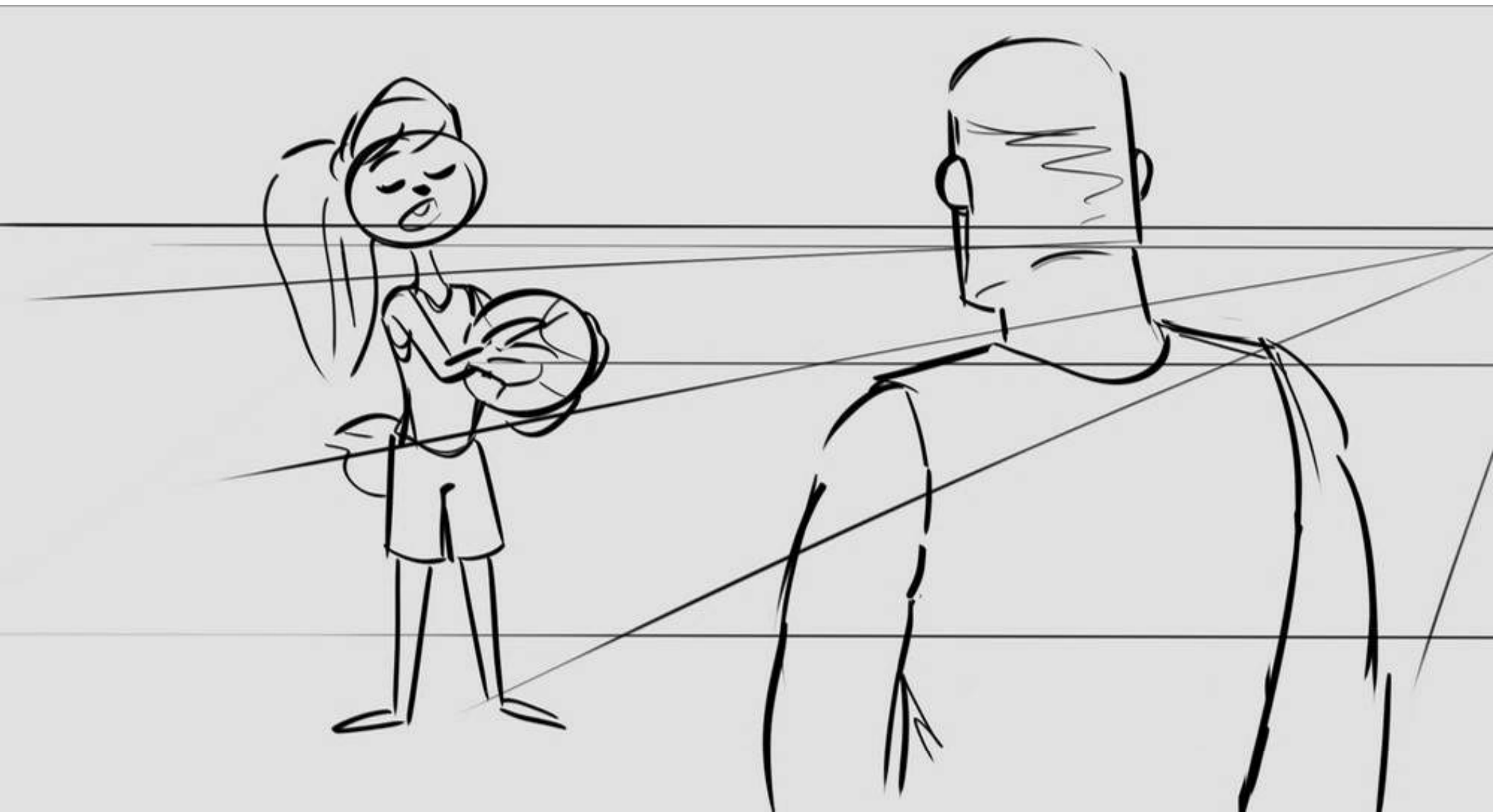

LOLA: nothing but net,

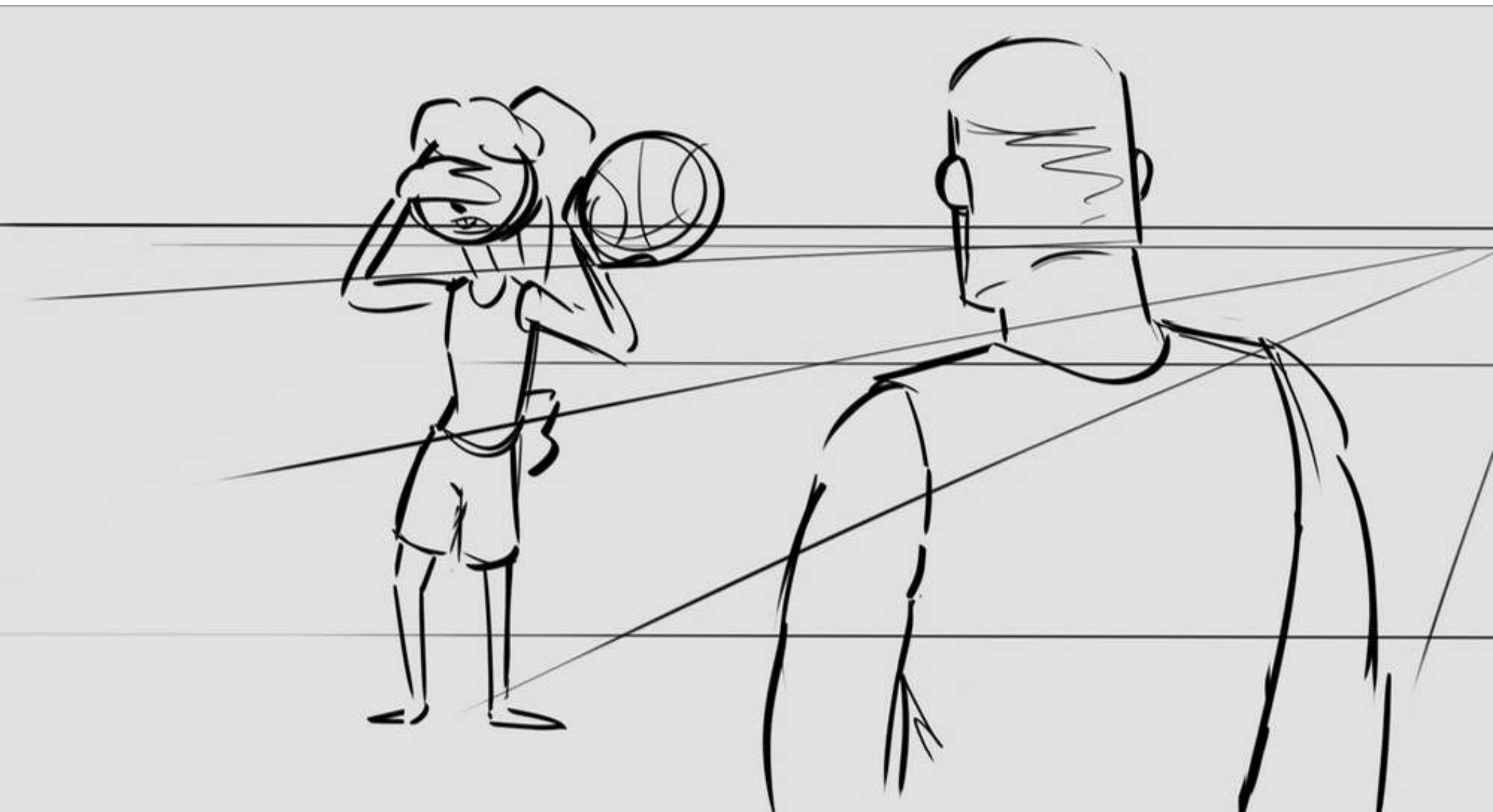

LOLA: eyes...closed.

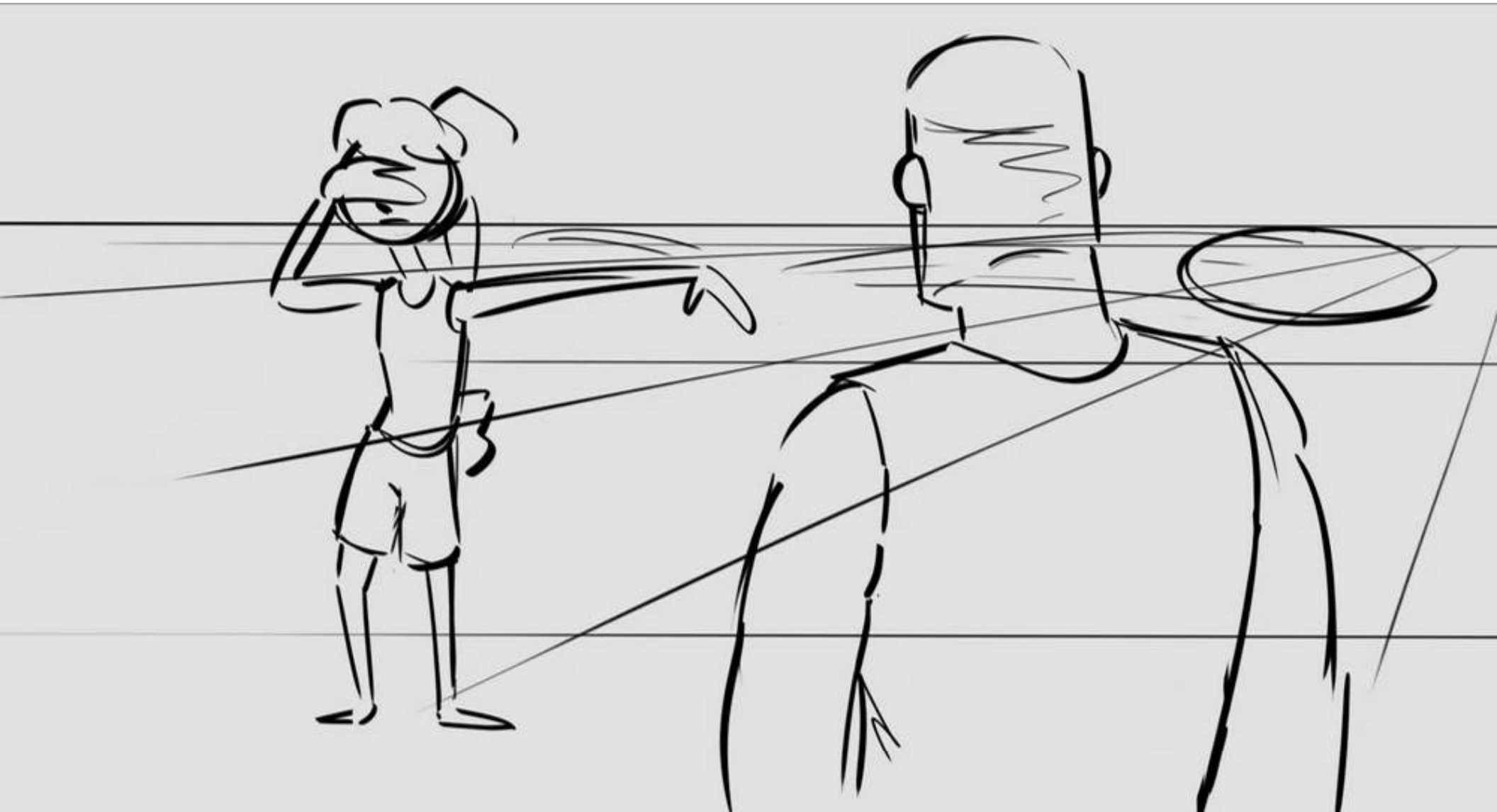

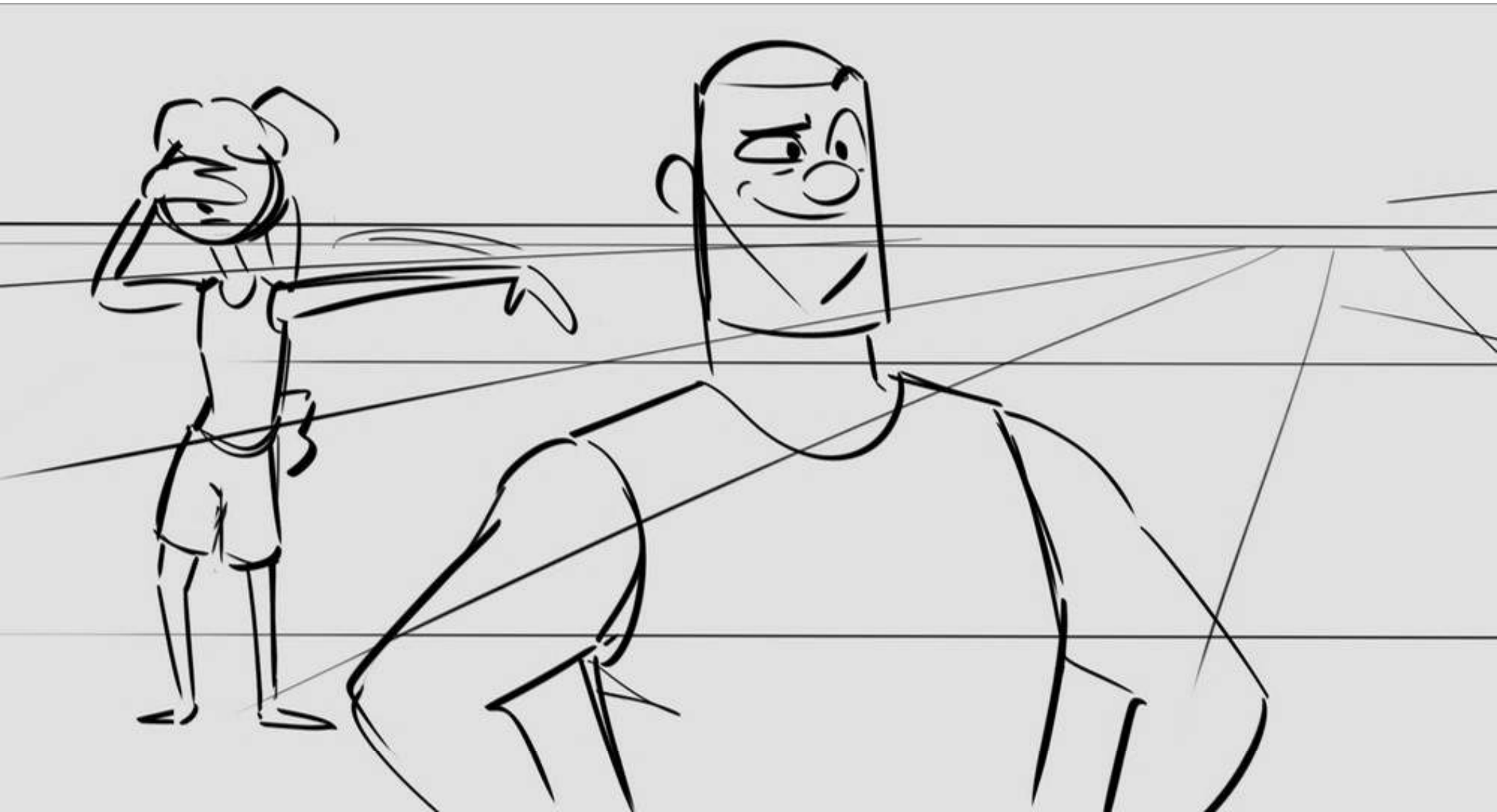

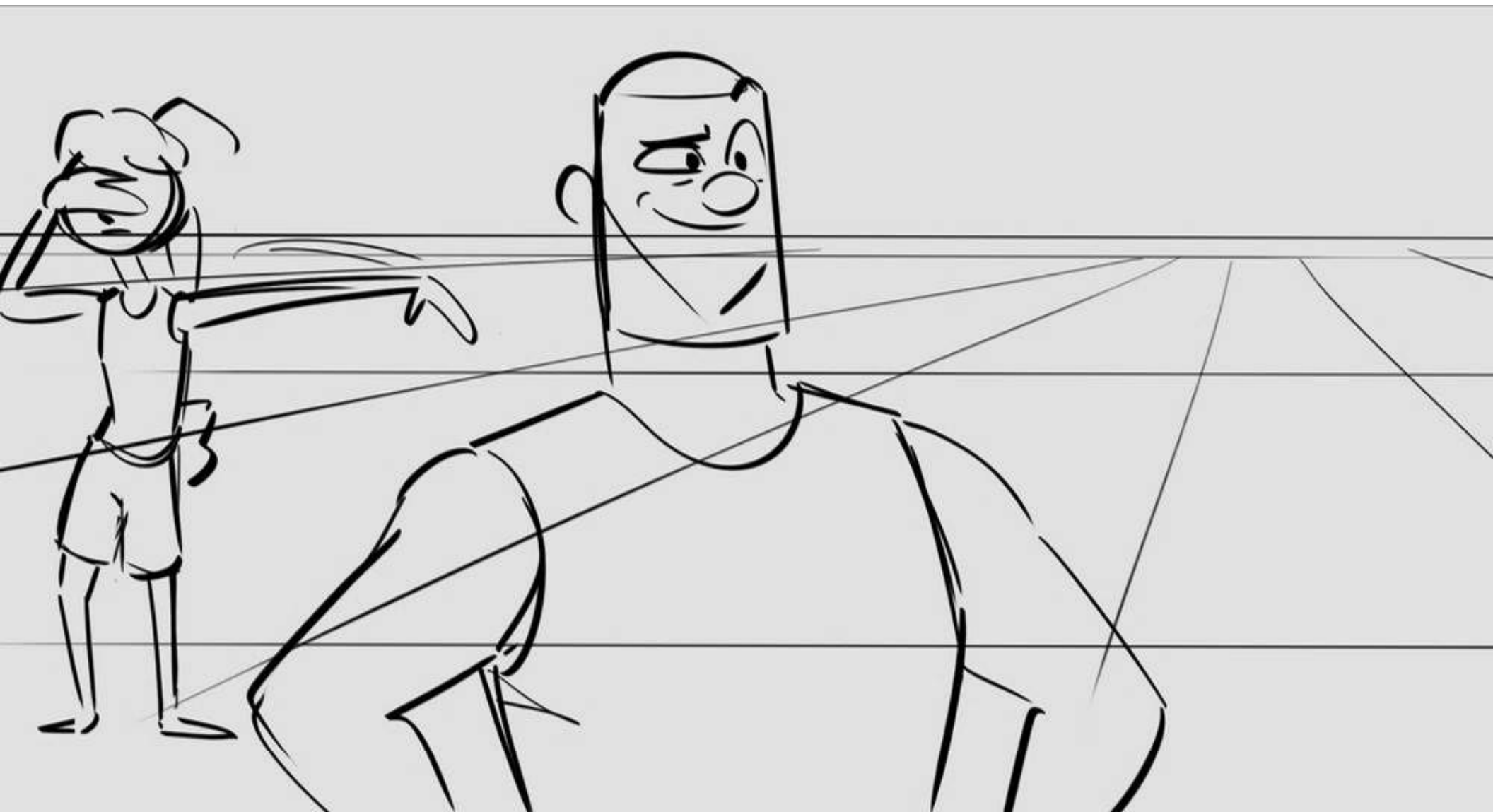

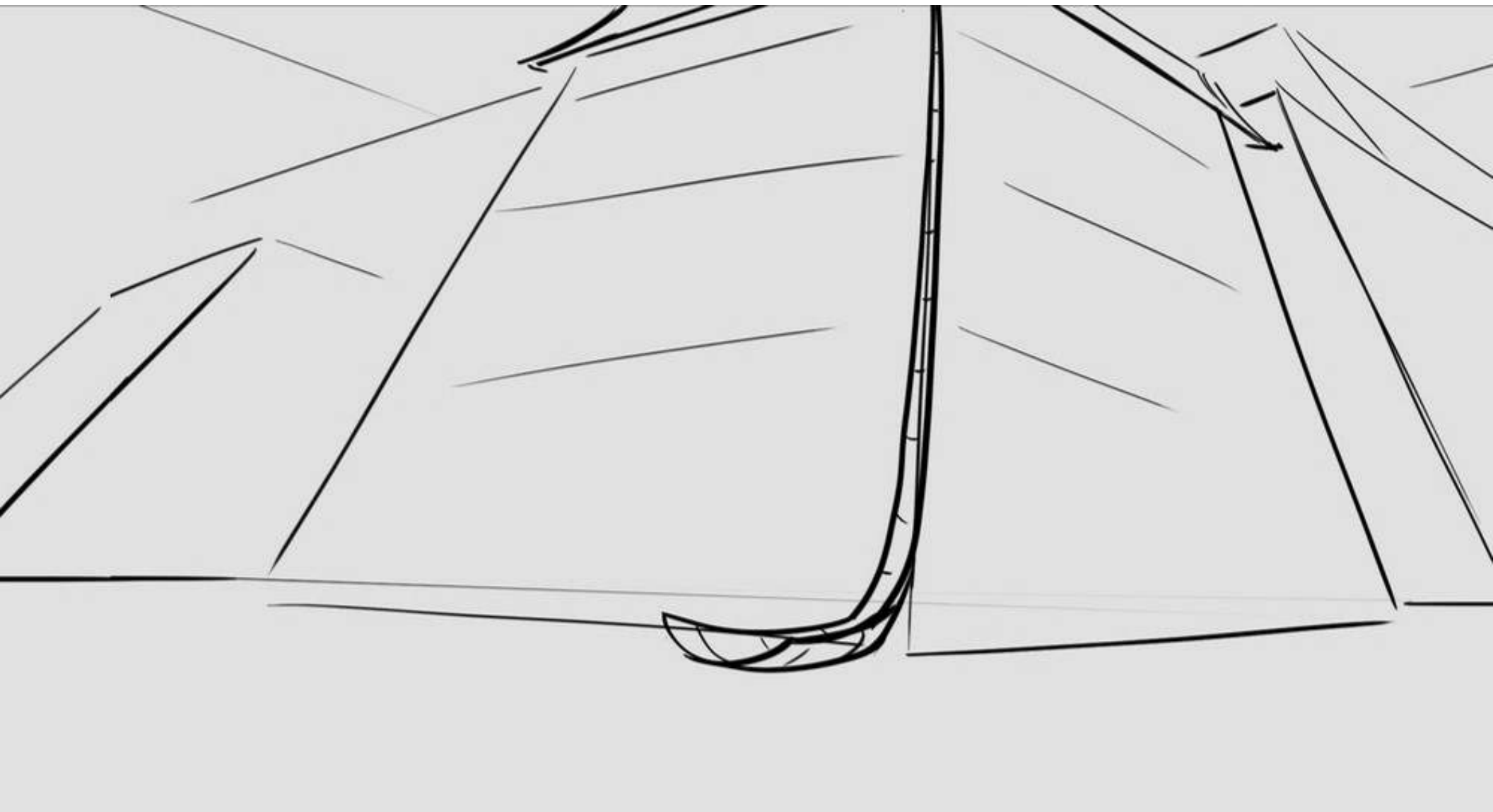

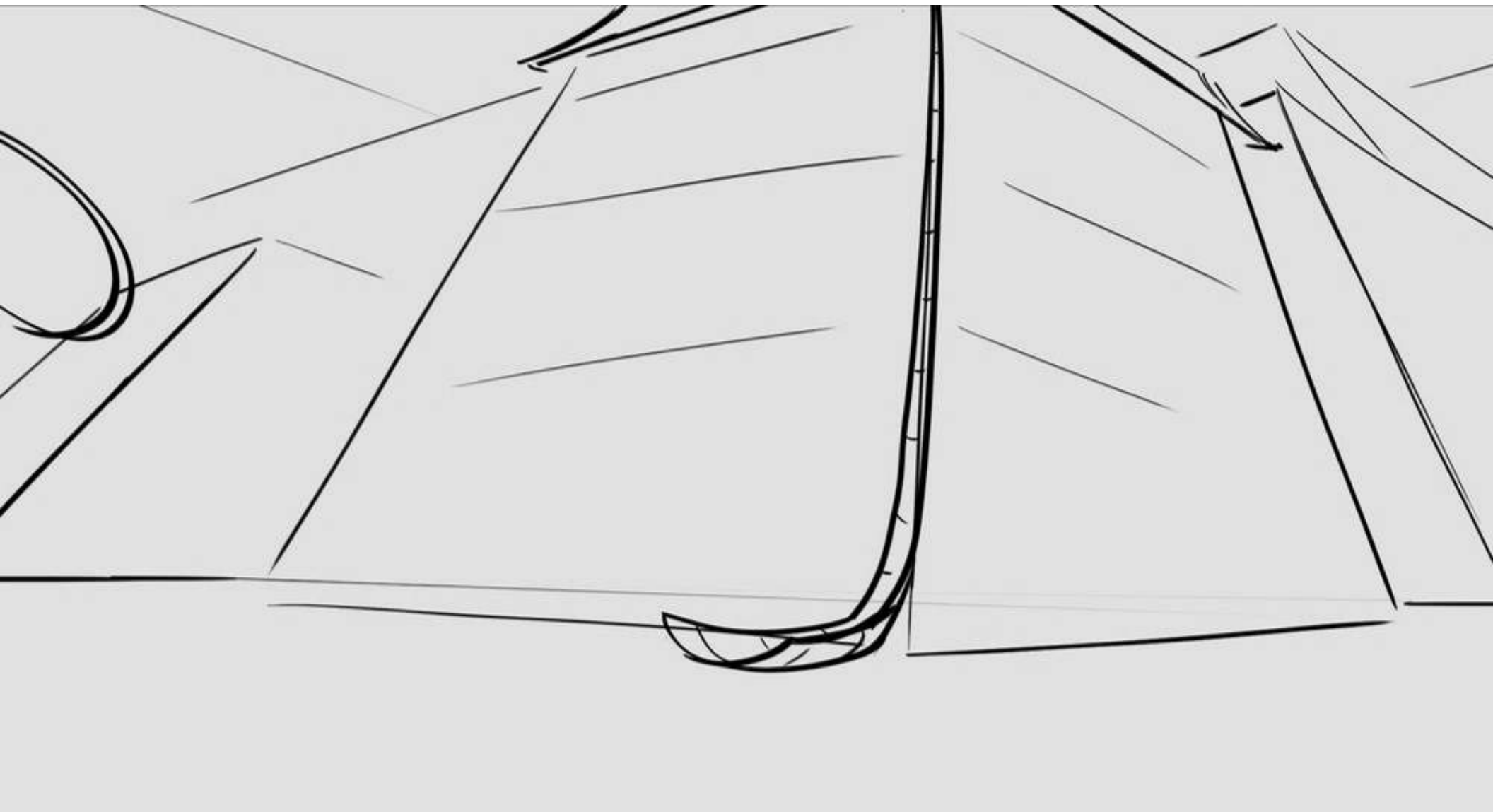

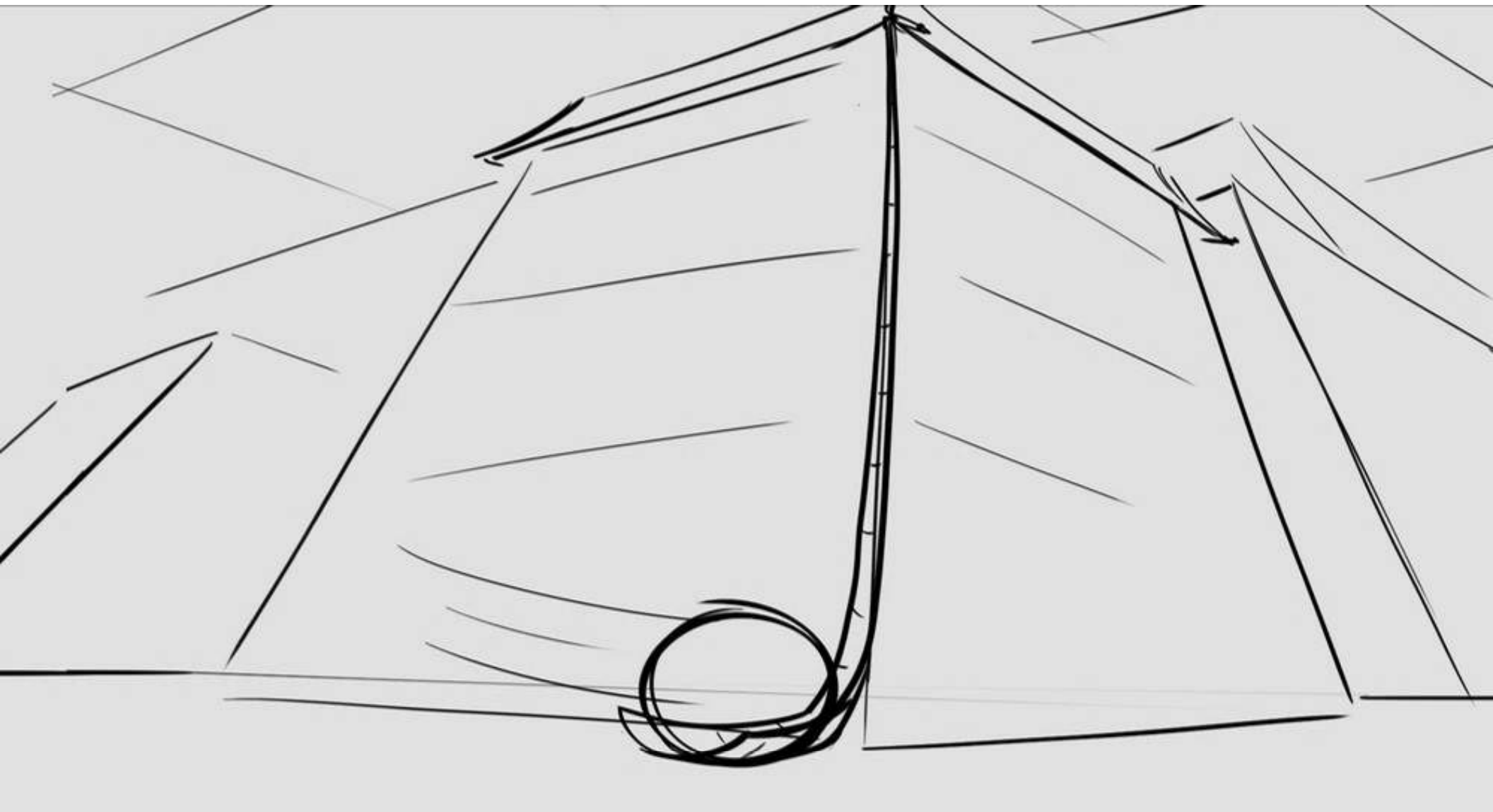

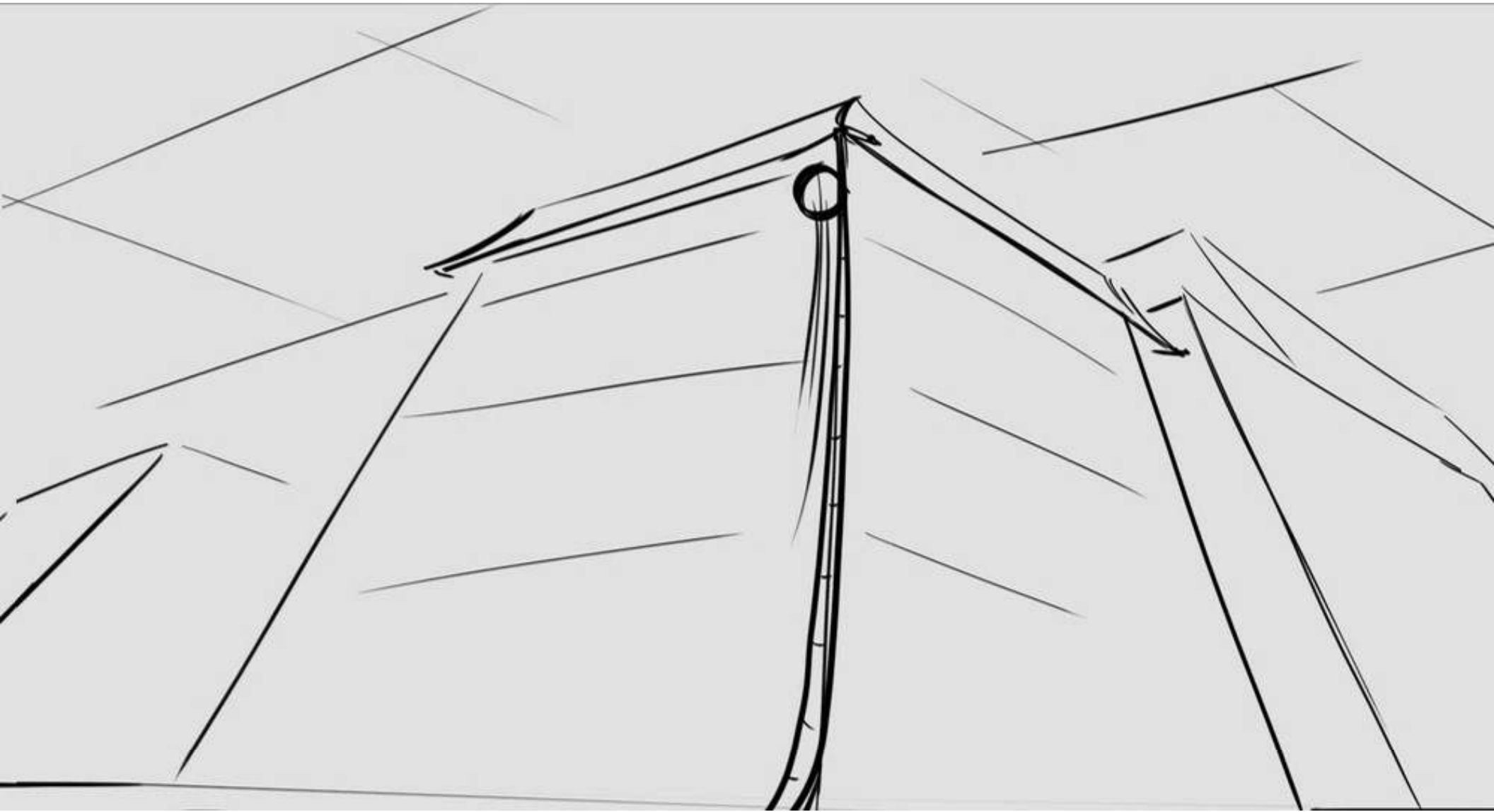

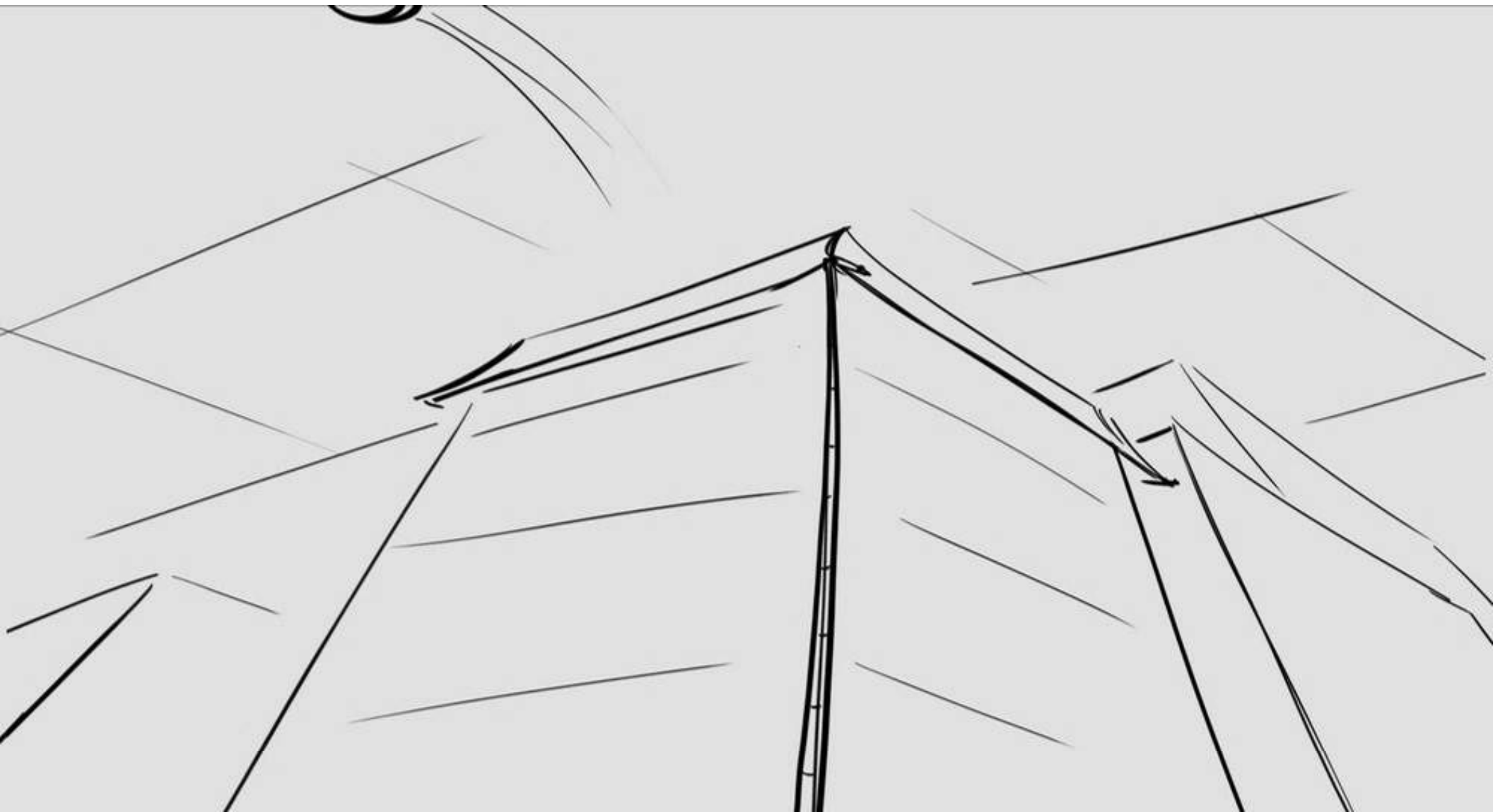

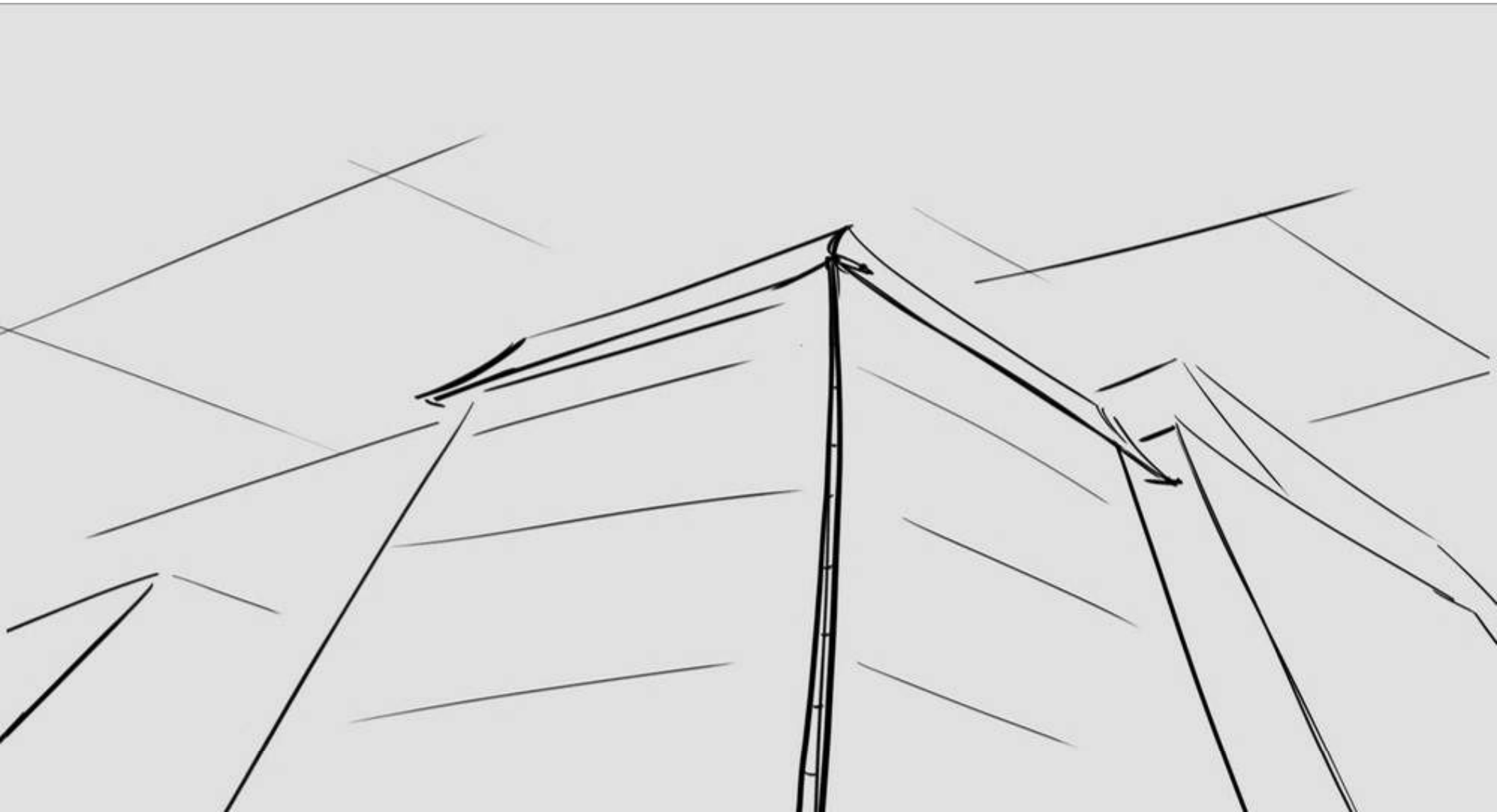

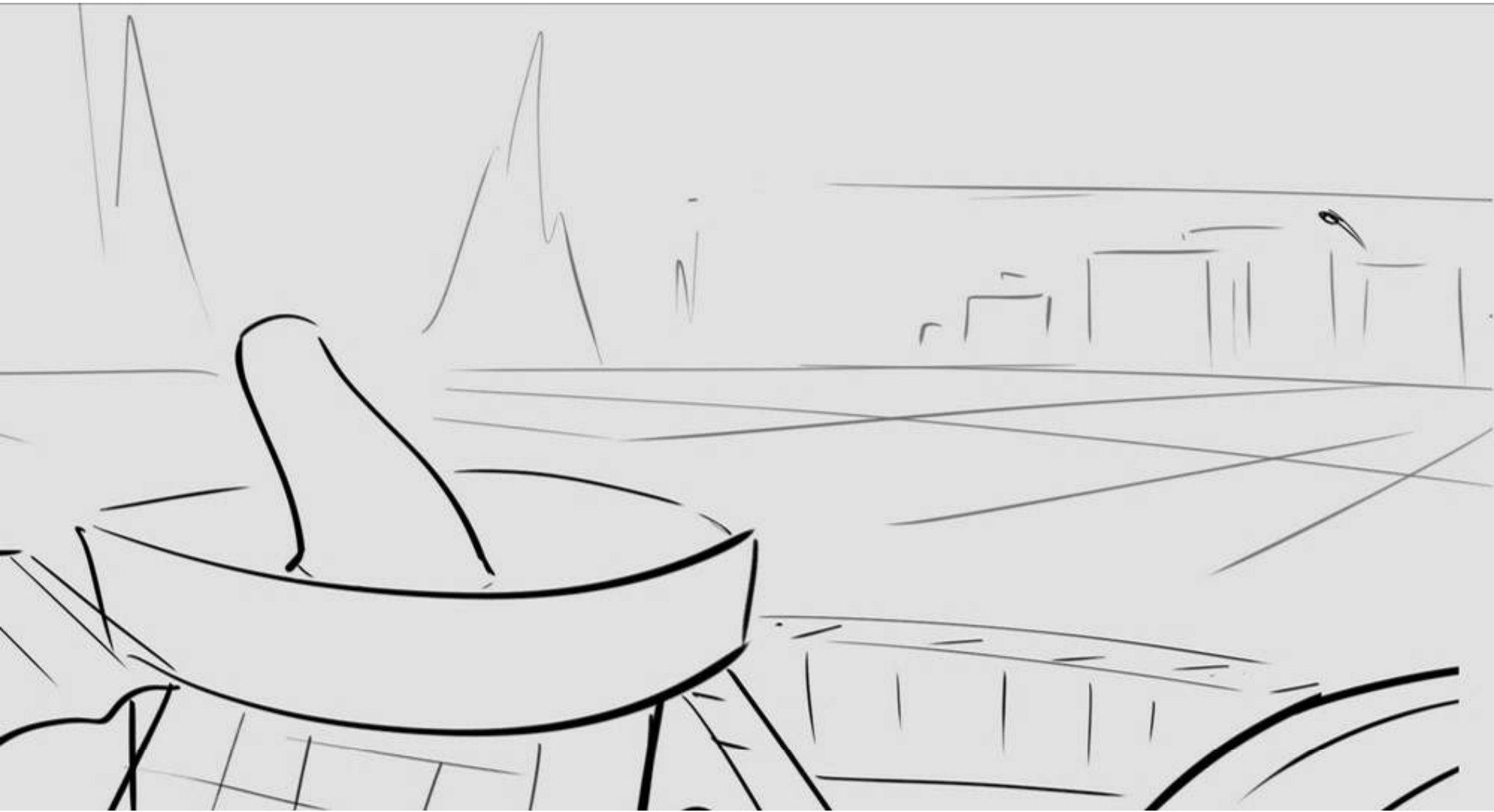

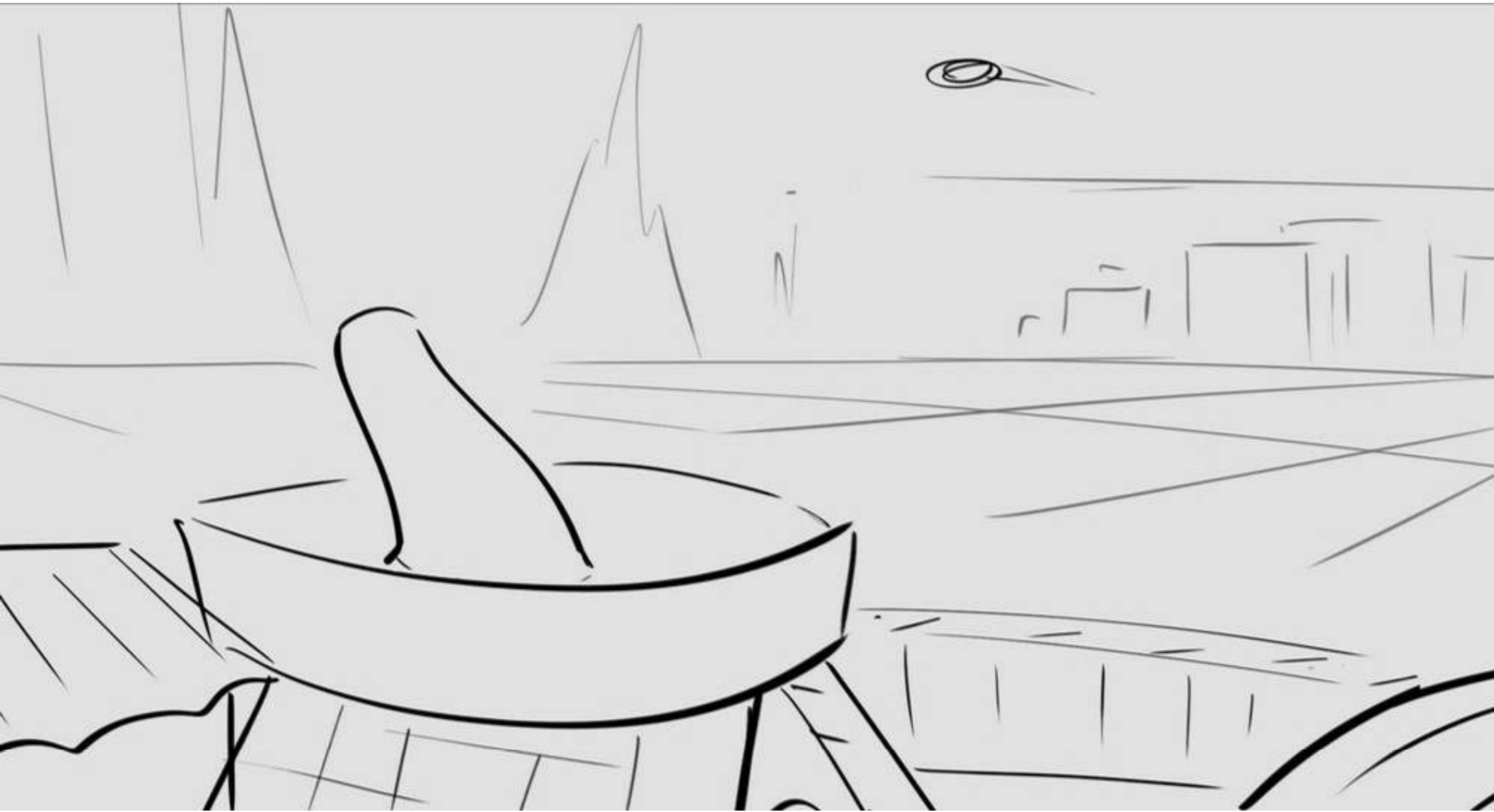

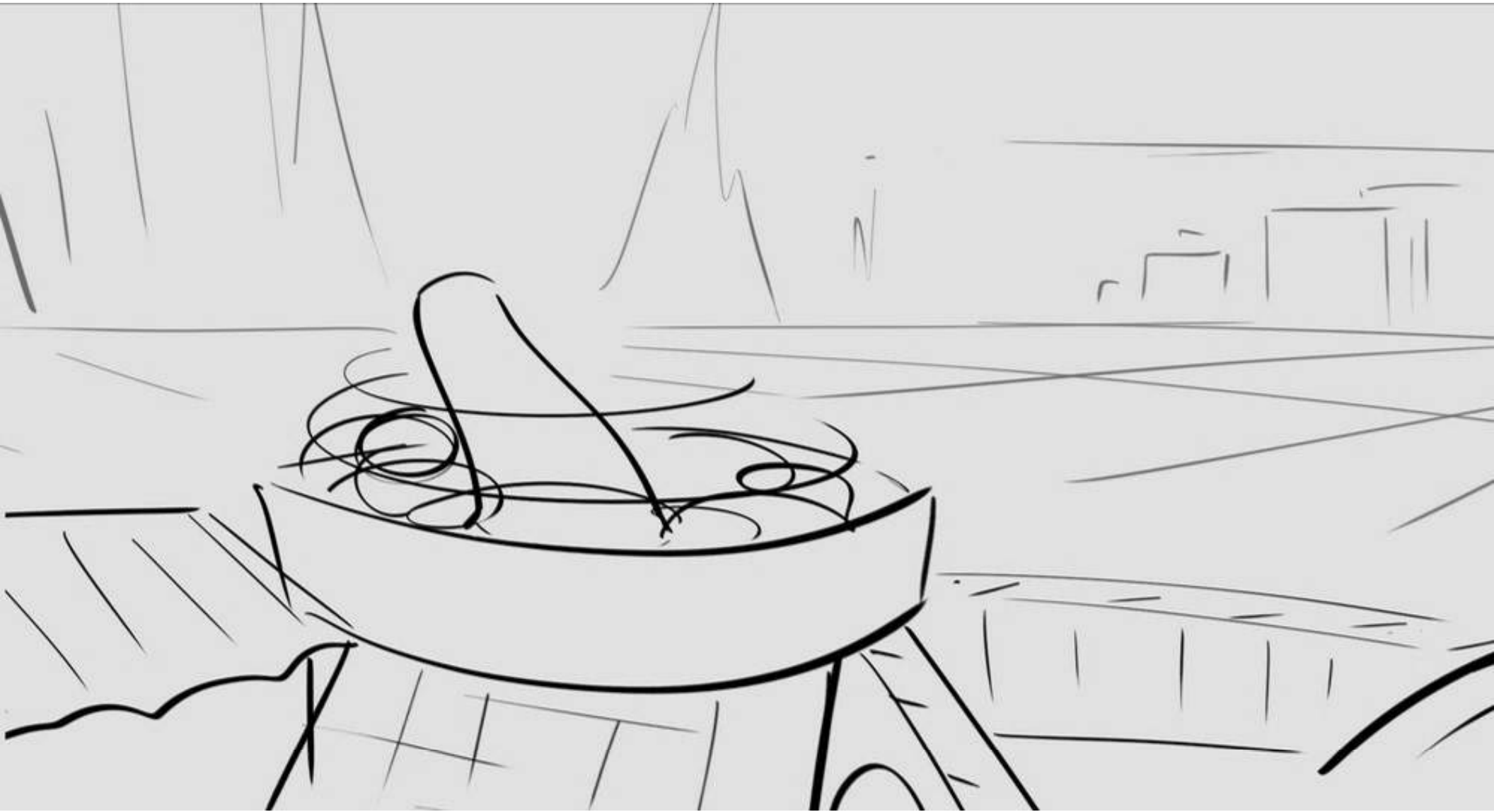

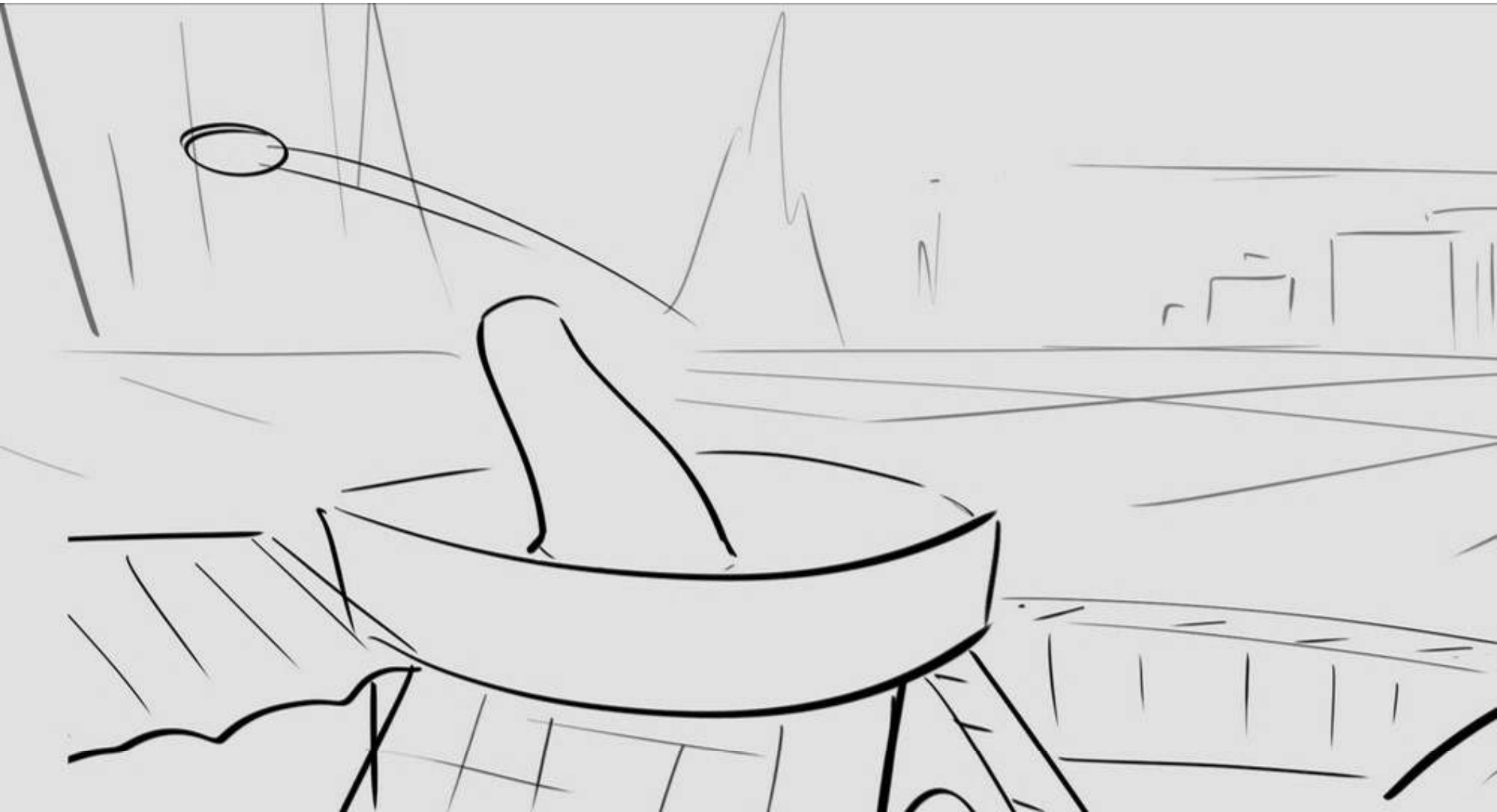

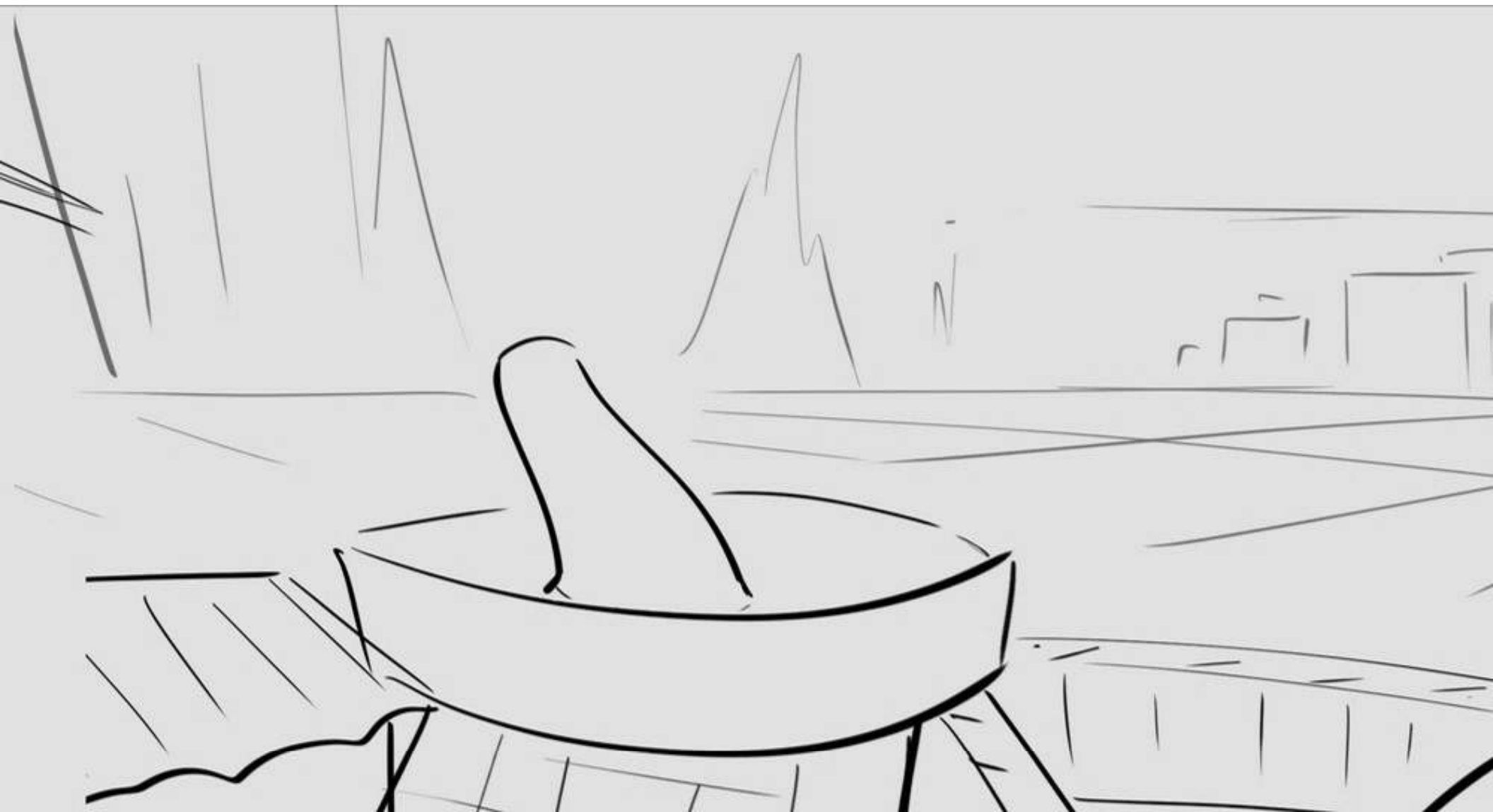

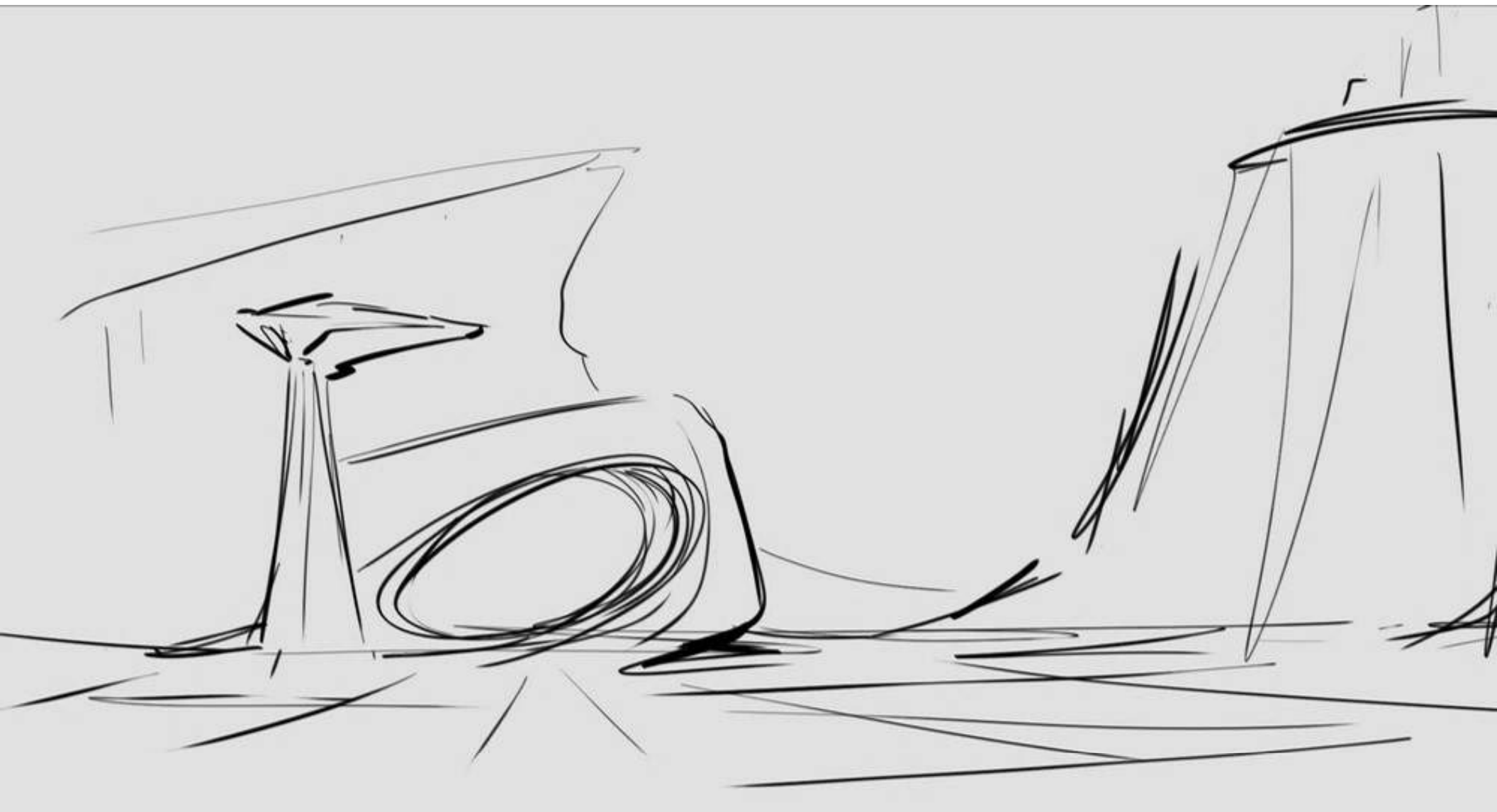

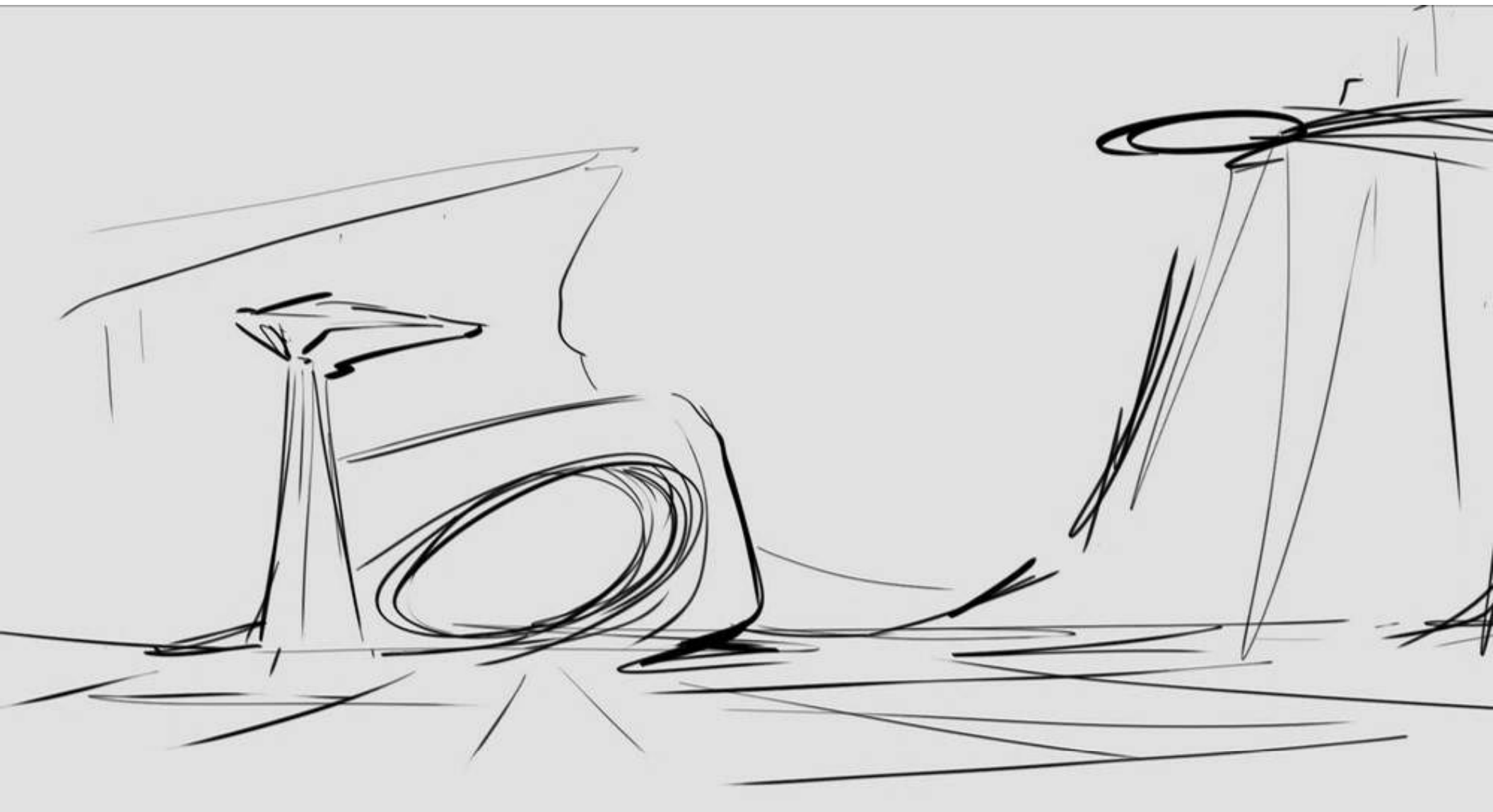

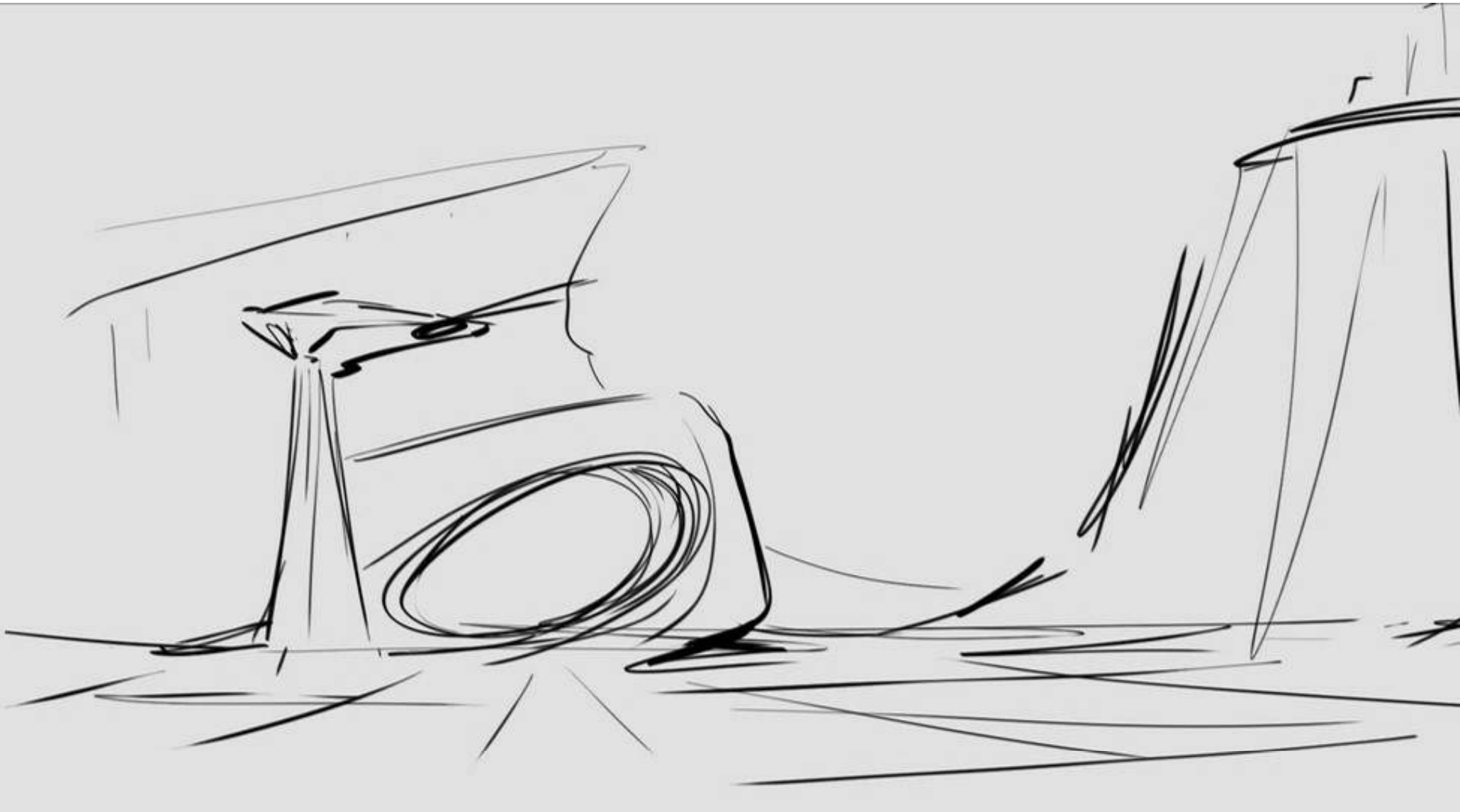

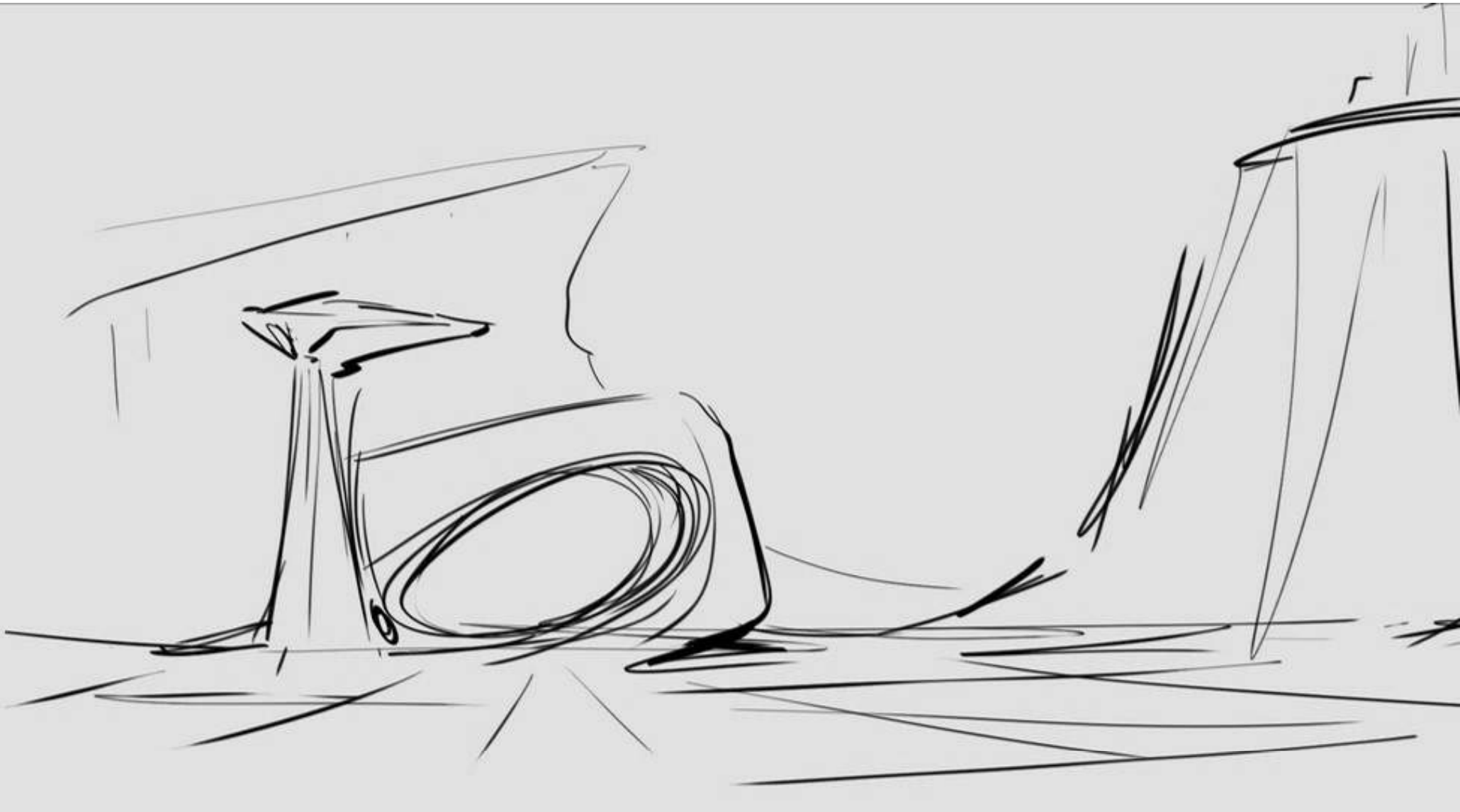

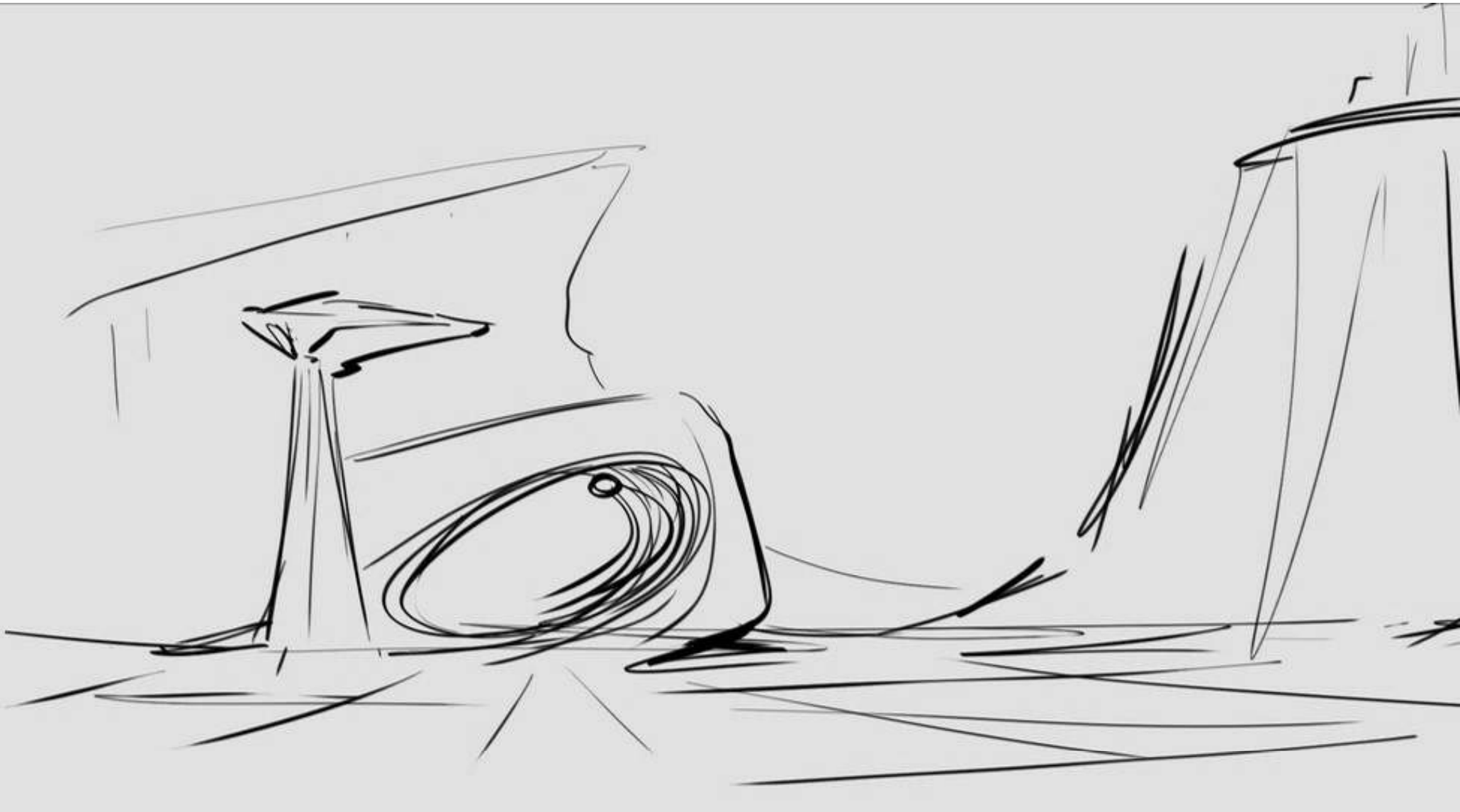

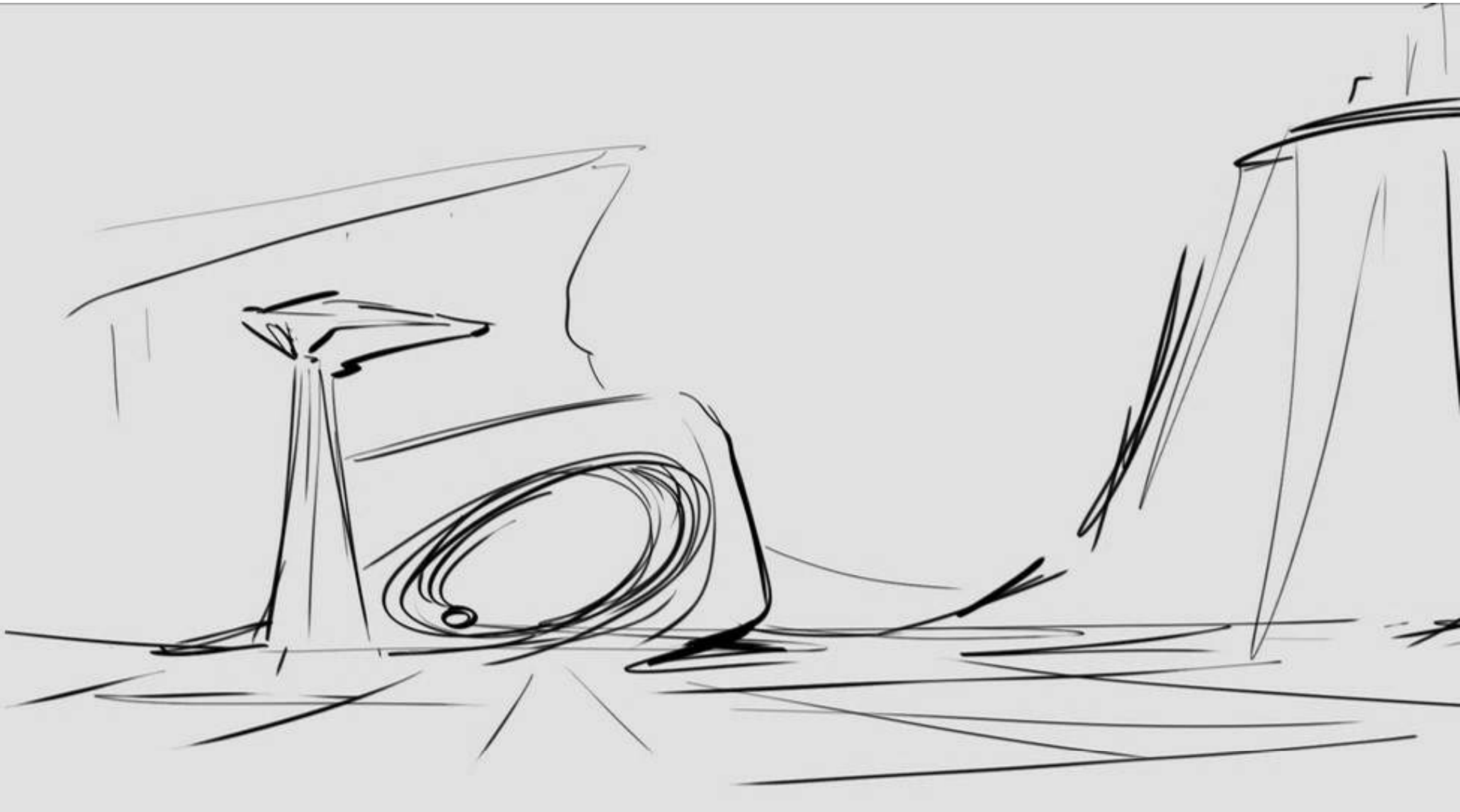

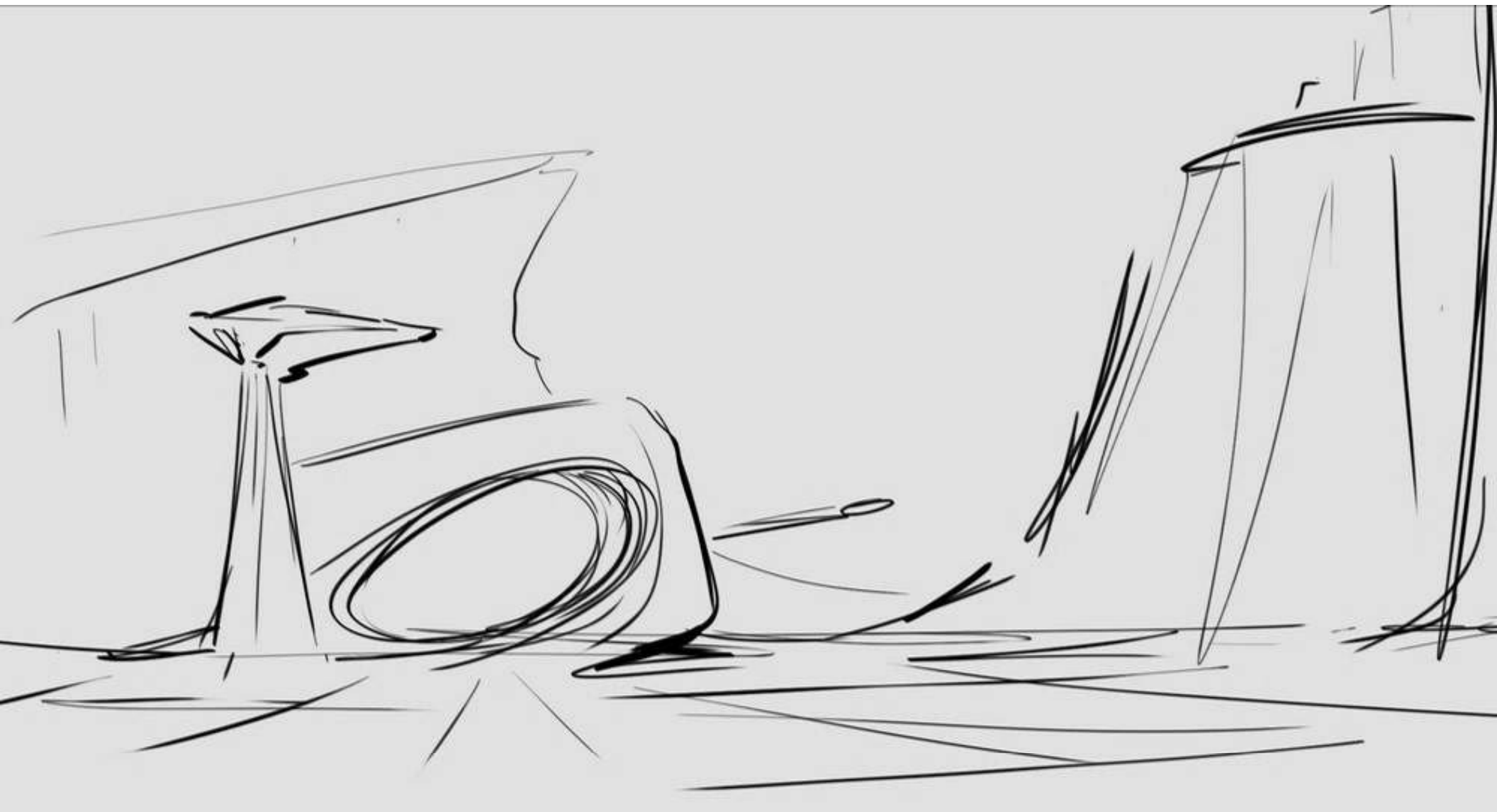

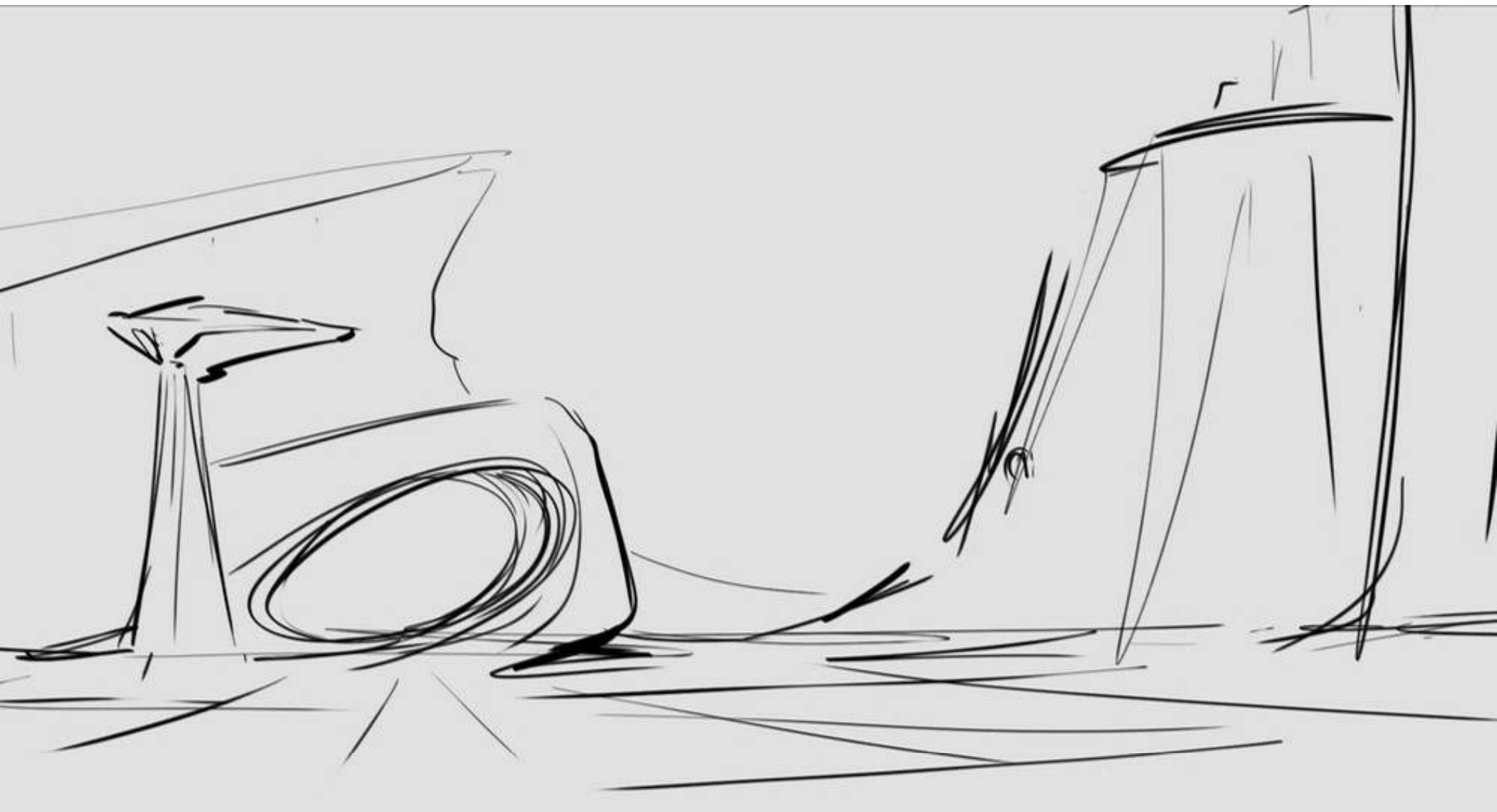

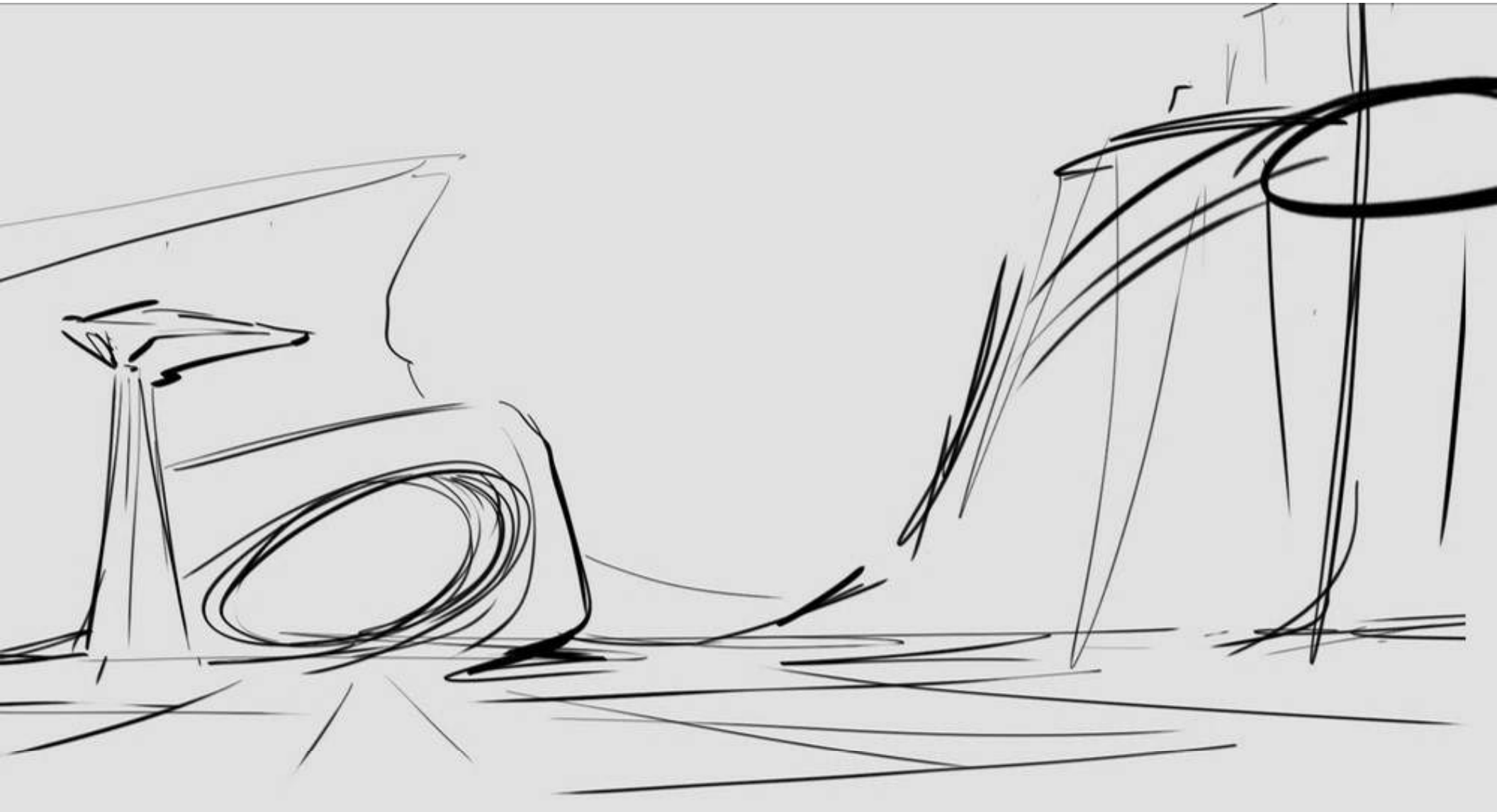

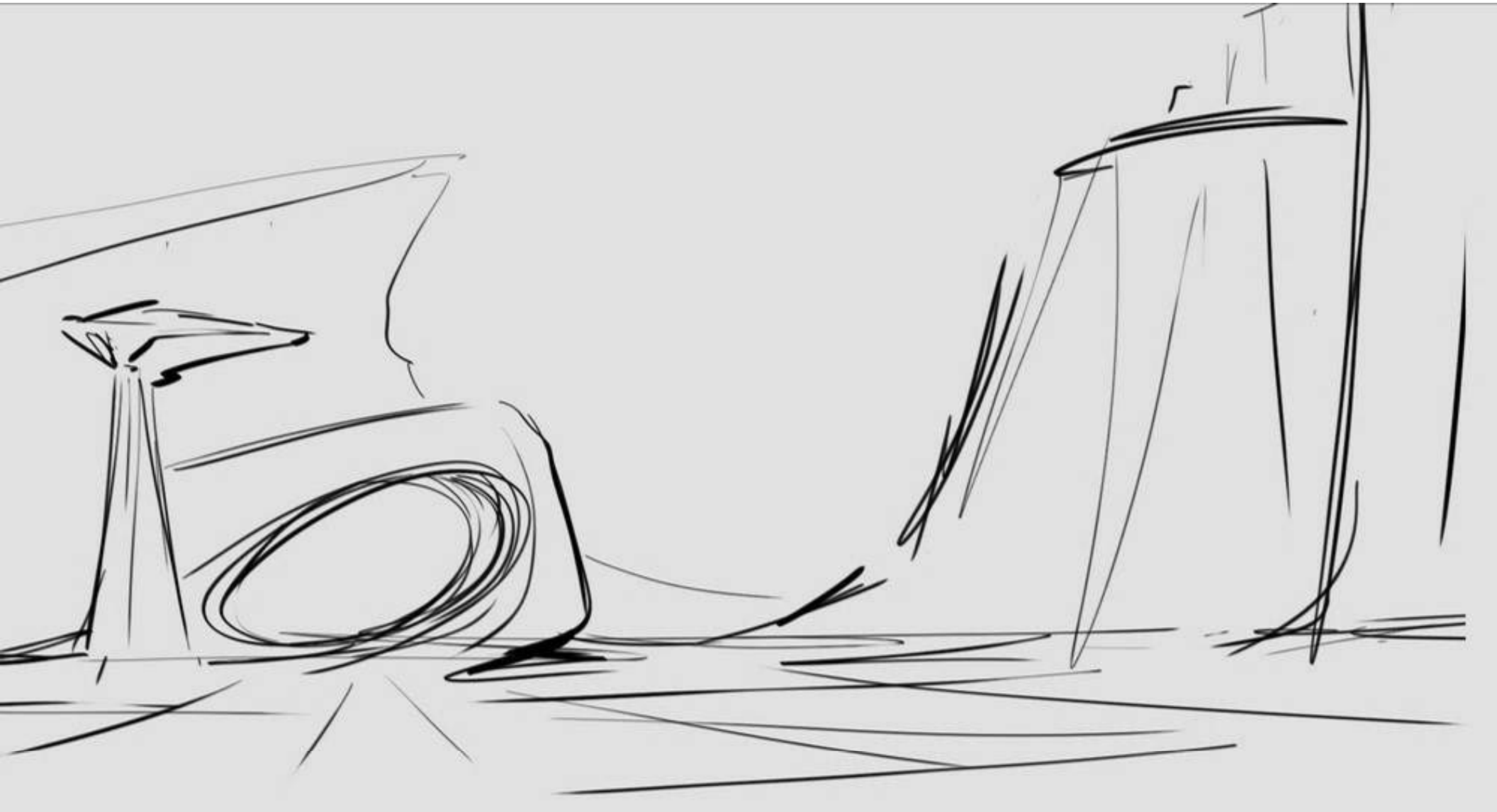











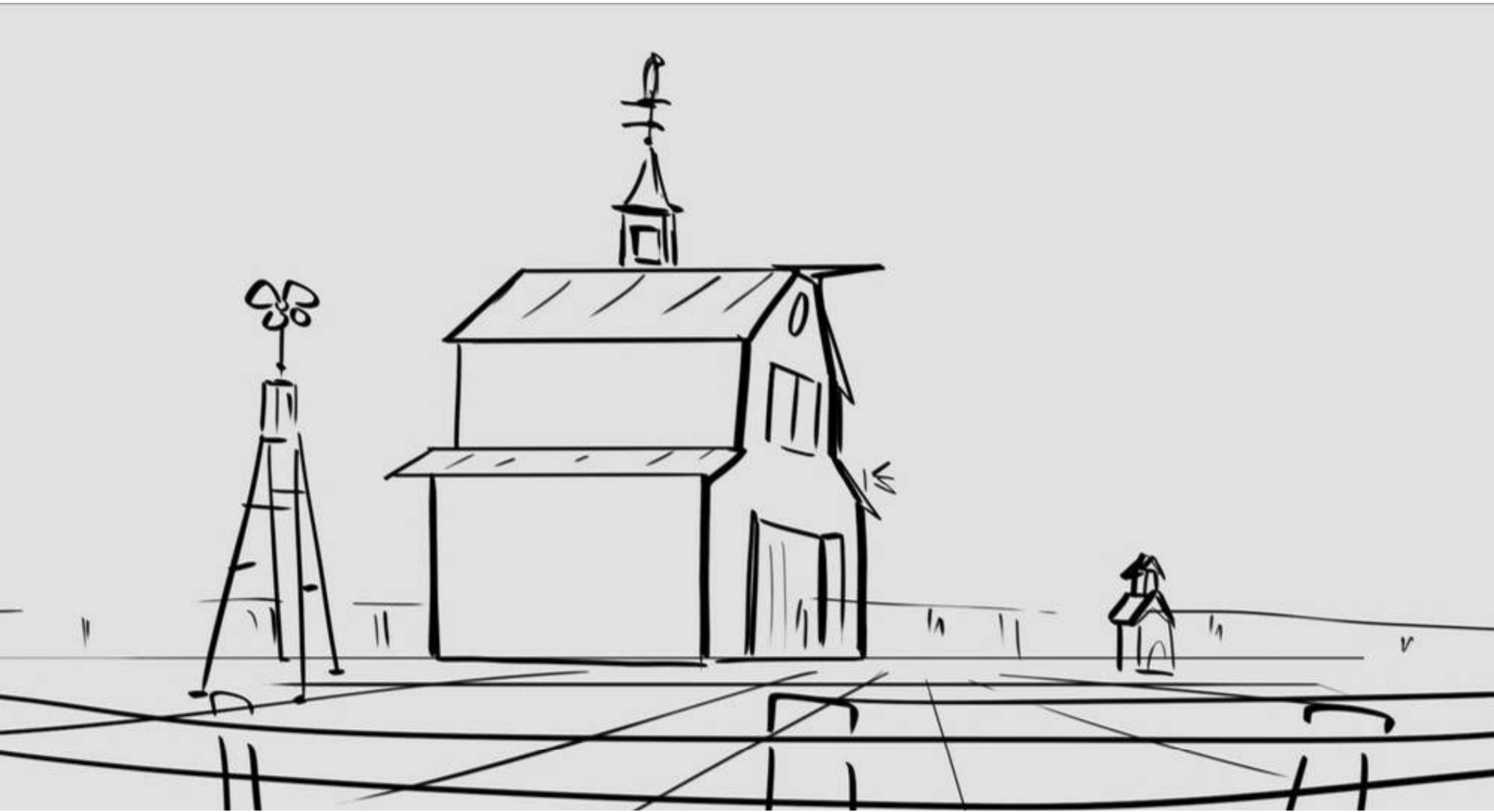















o

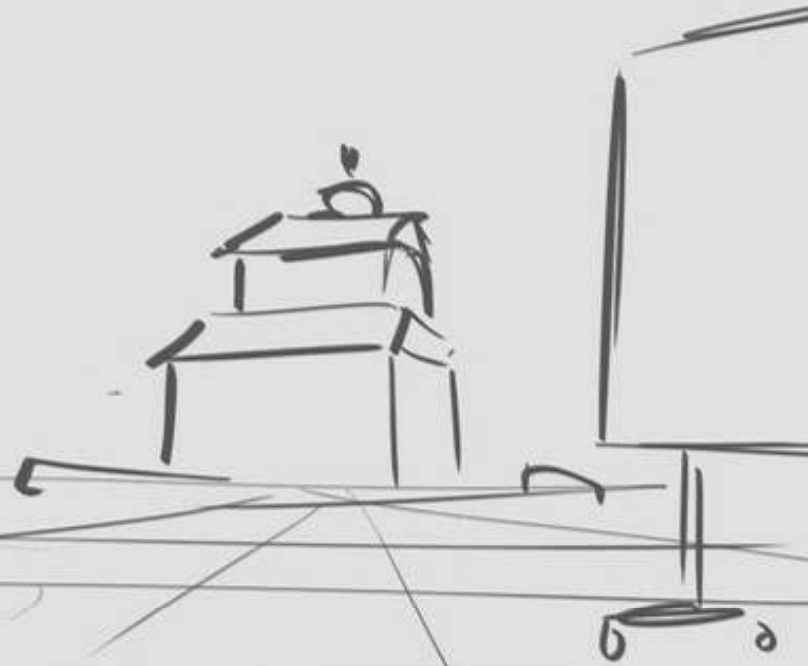





zzz



Sports
or
work

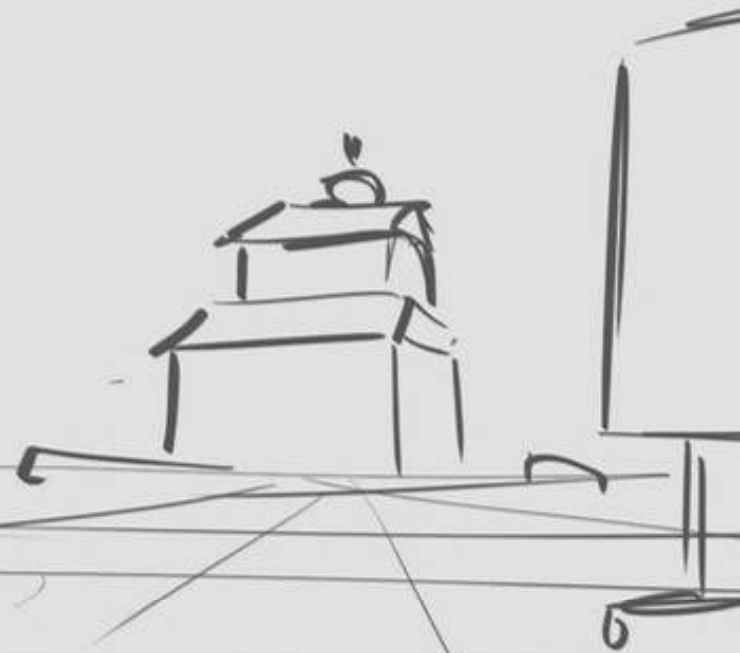

6



DAFFY: (SNOOOORE)



DAFFY: (SNOOOORE)



DAFFY: (SNOOOORE)

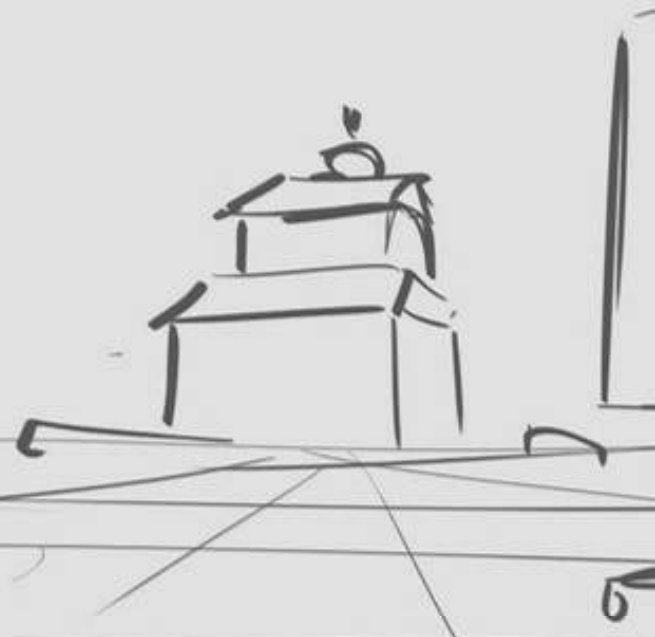

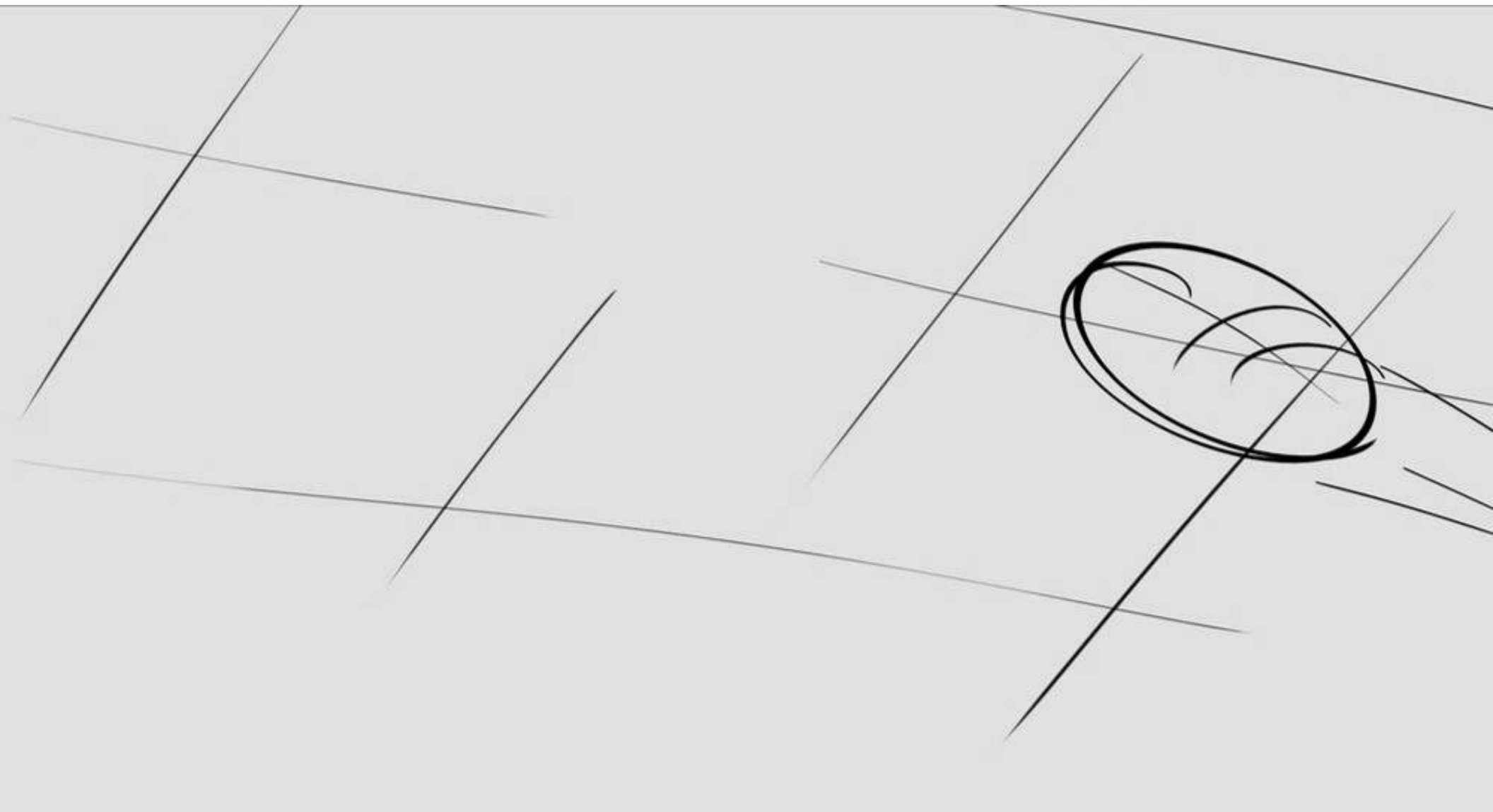

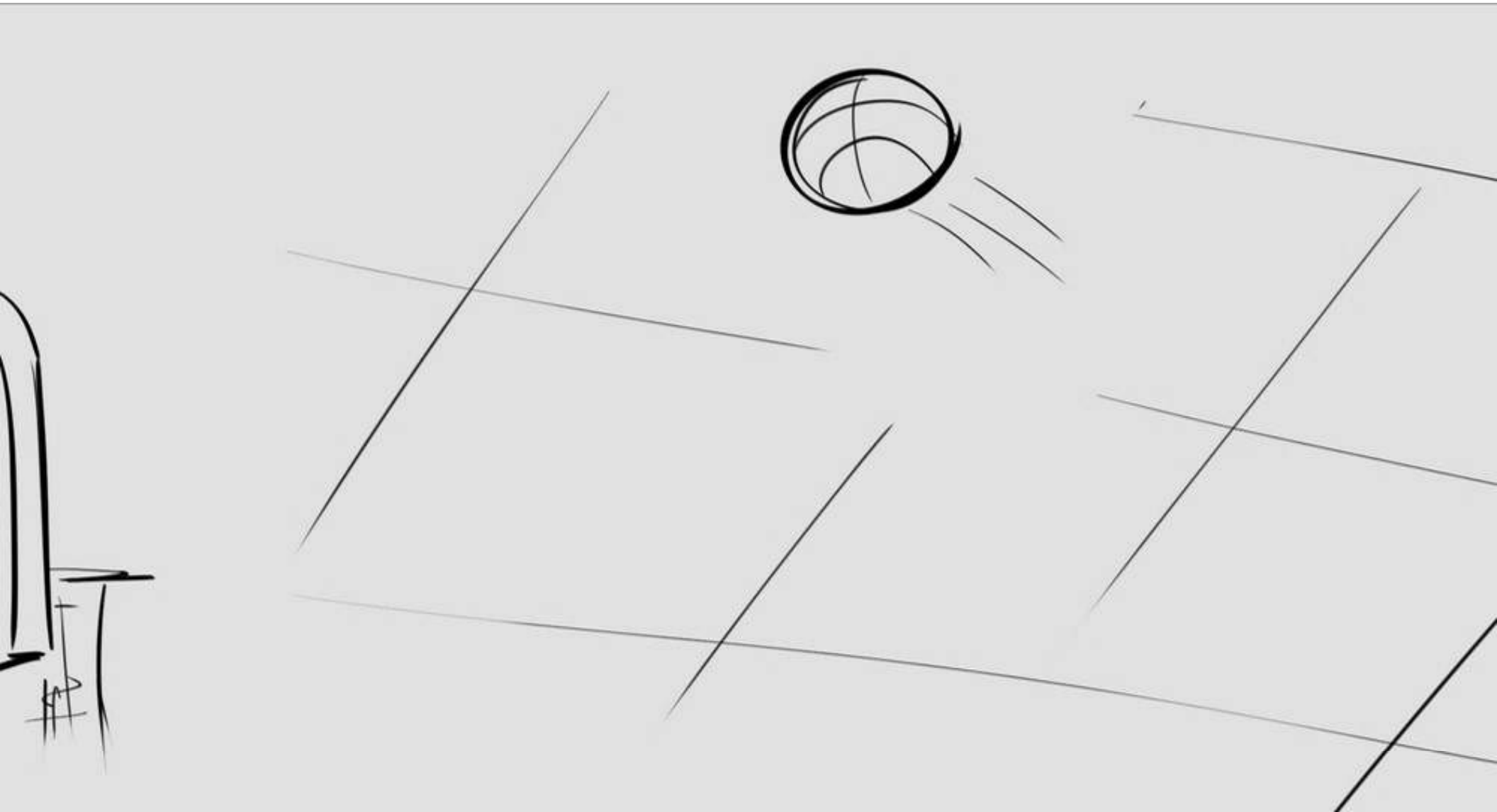



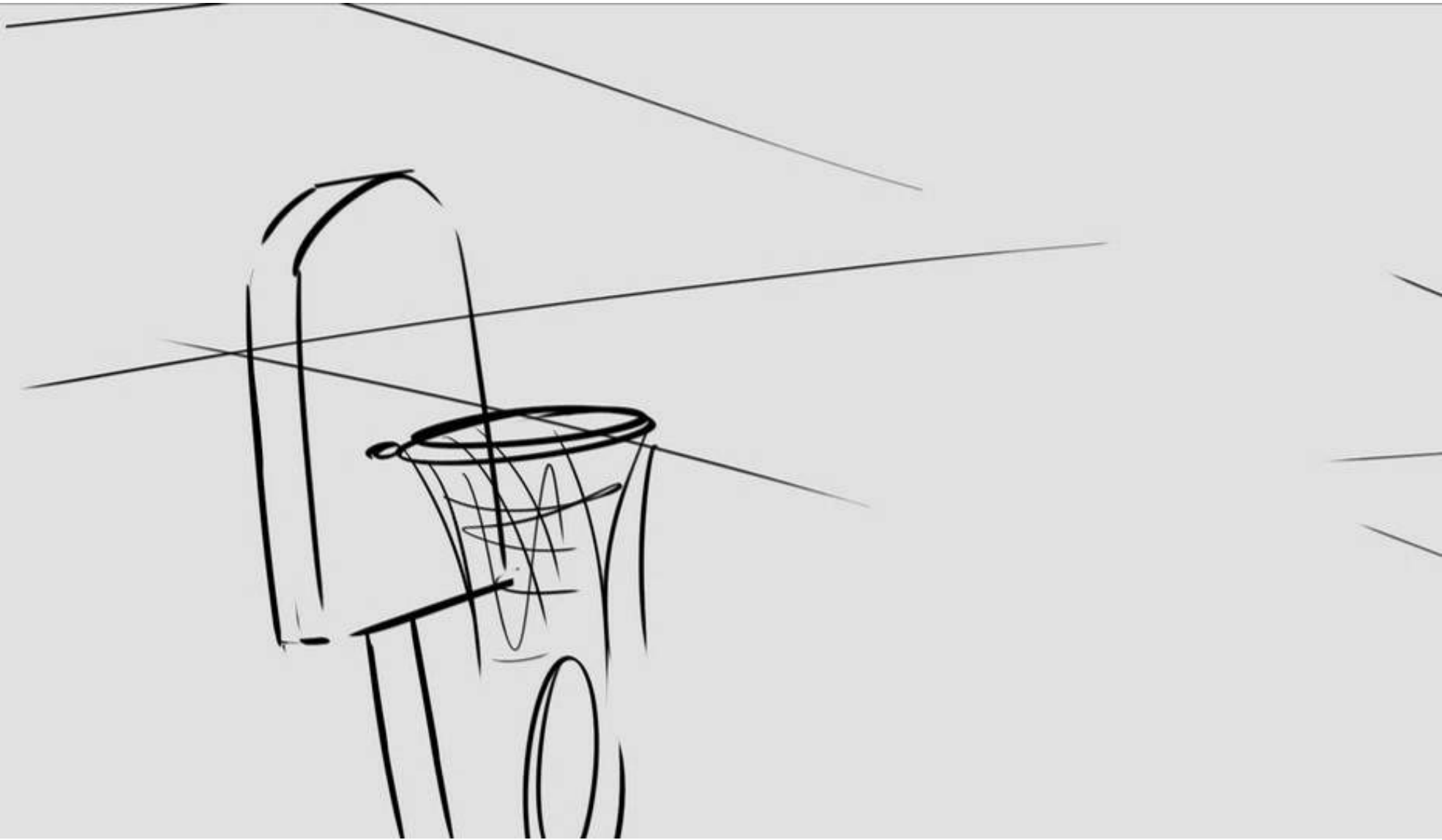

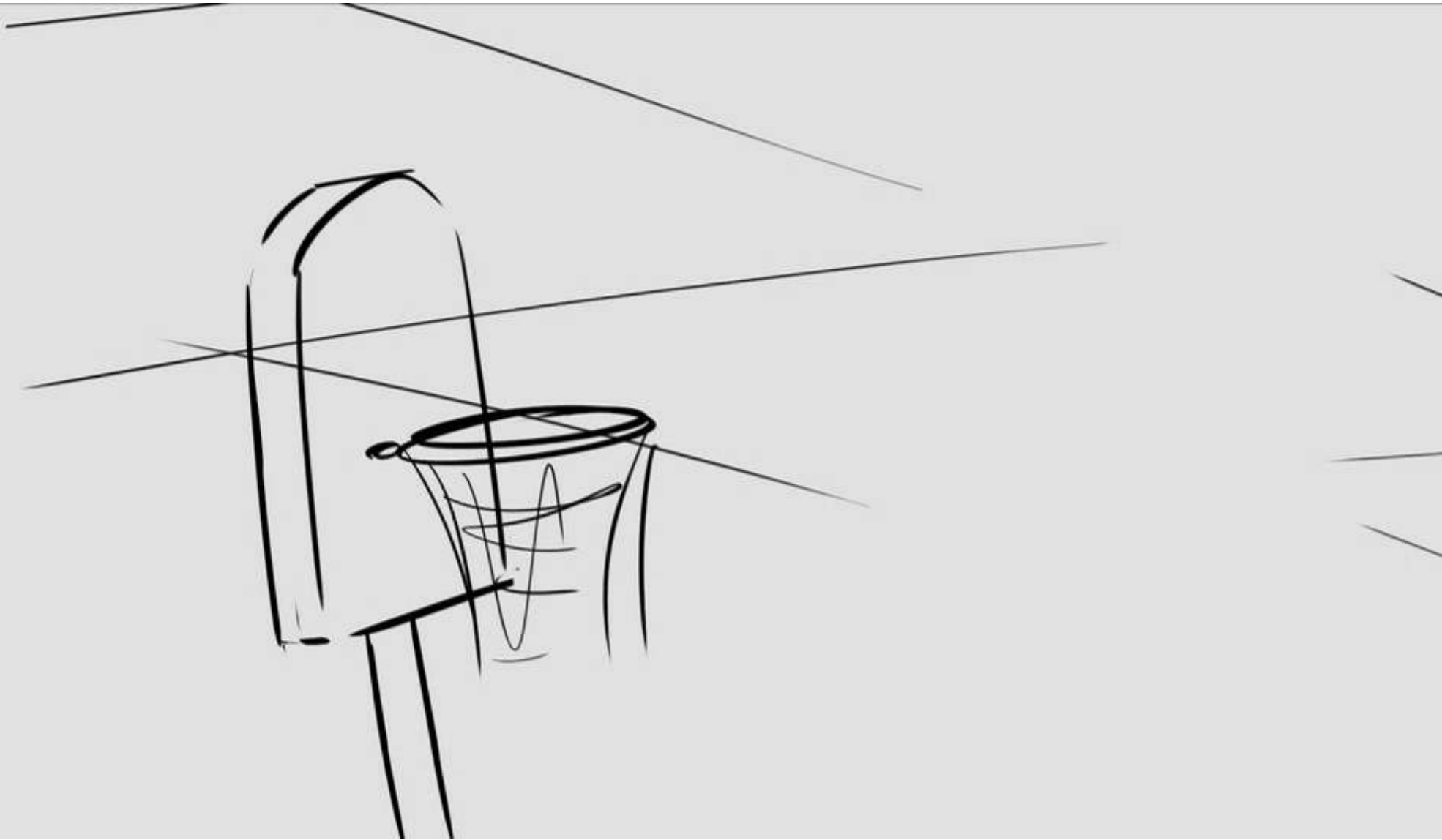

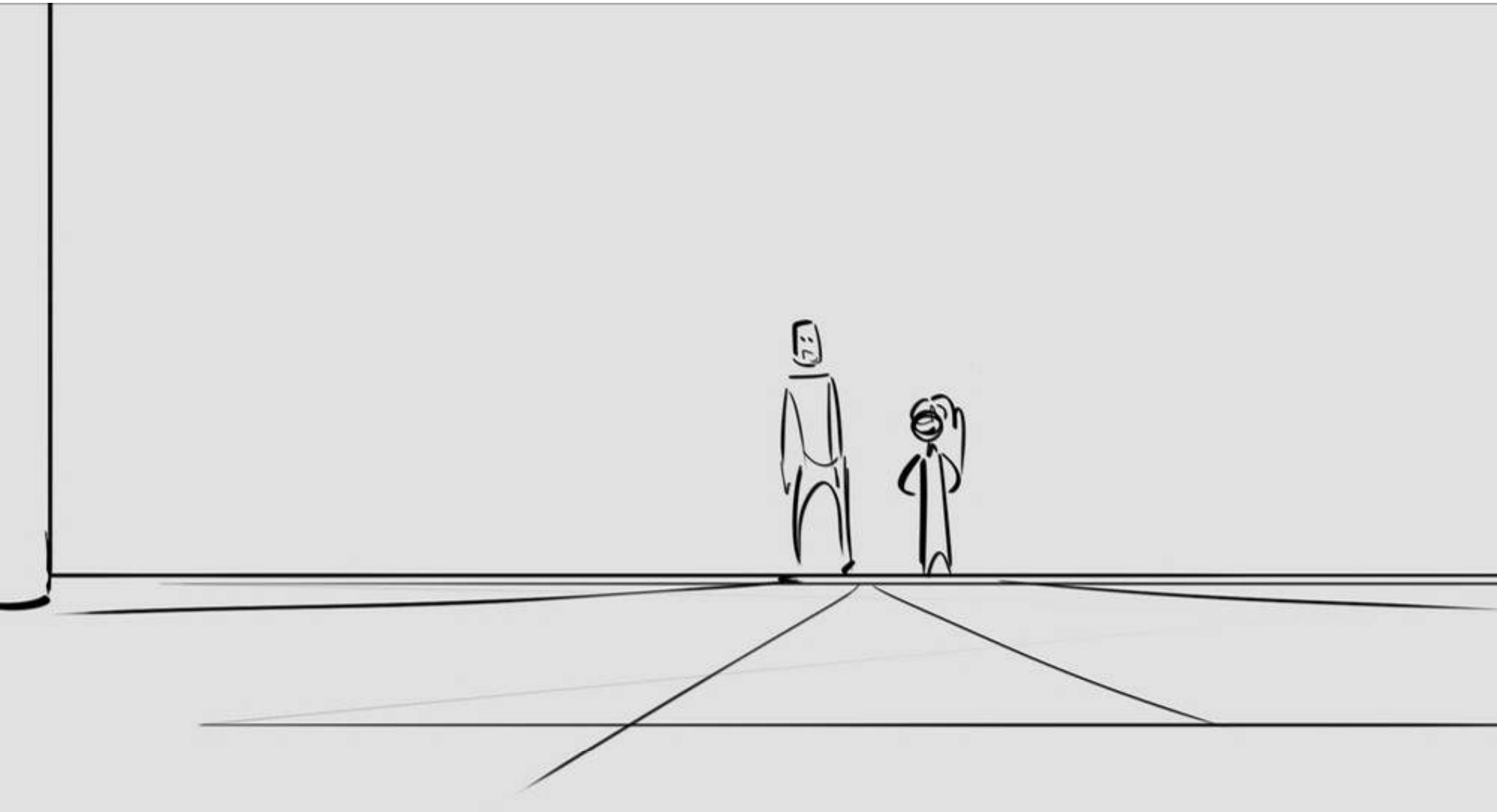

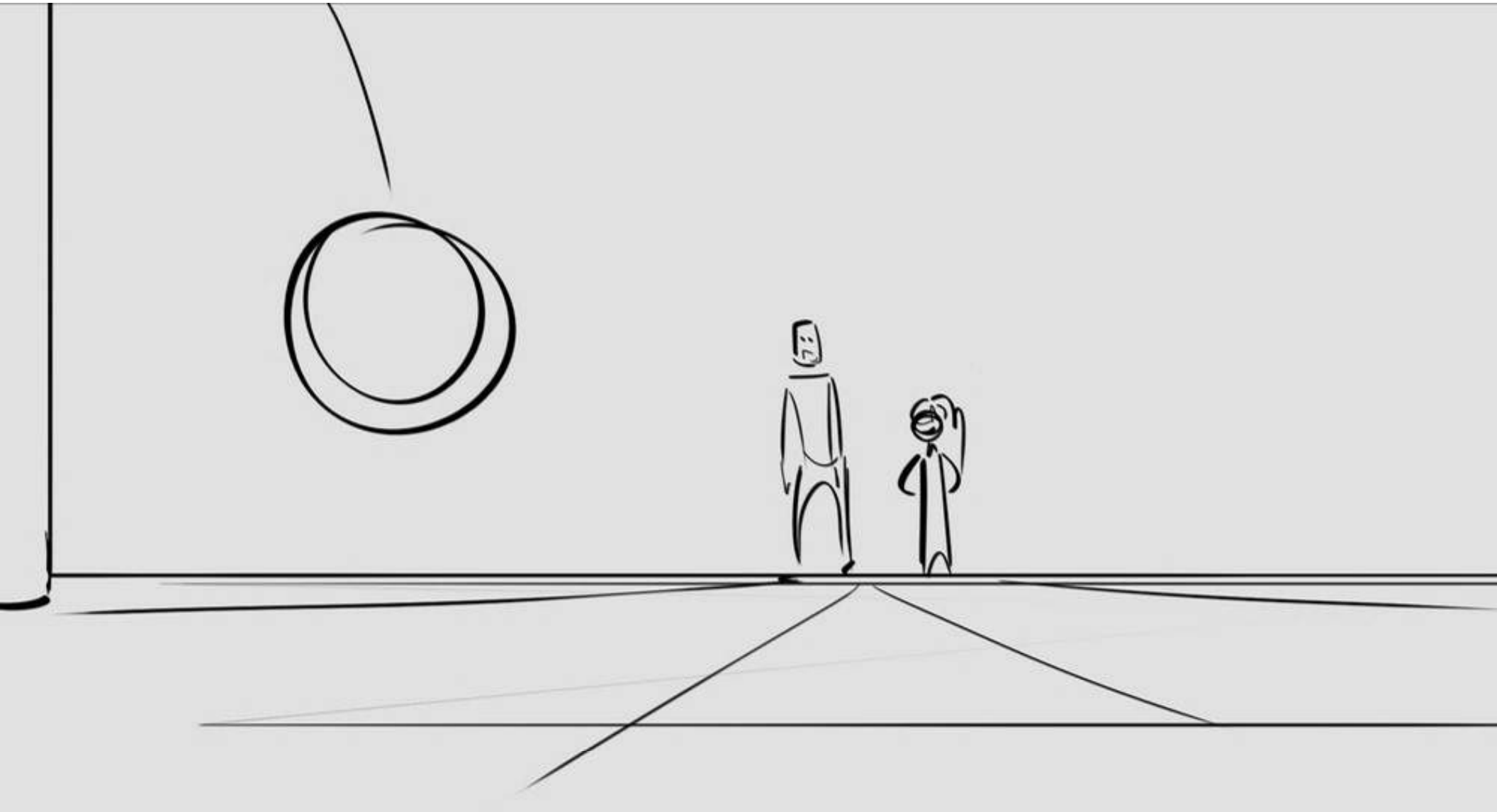

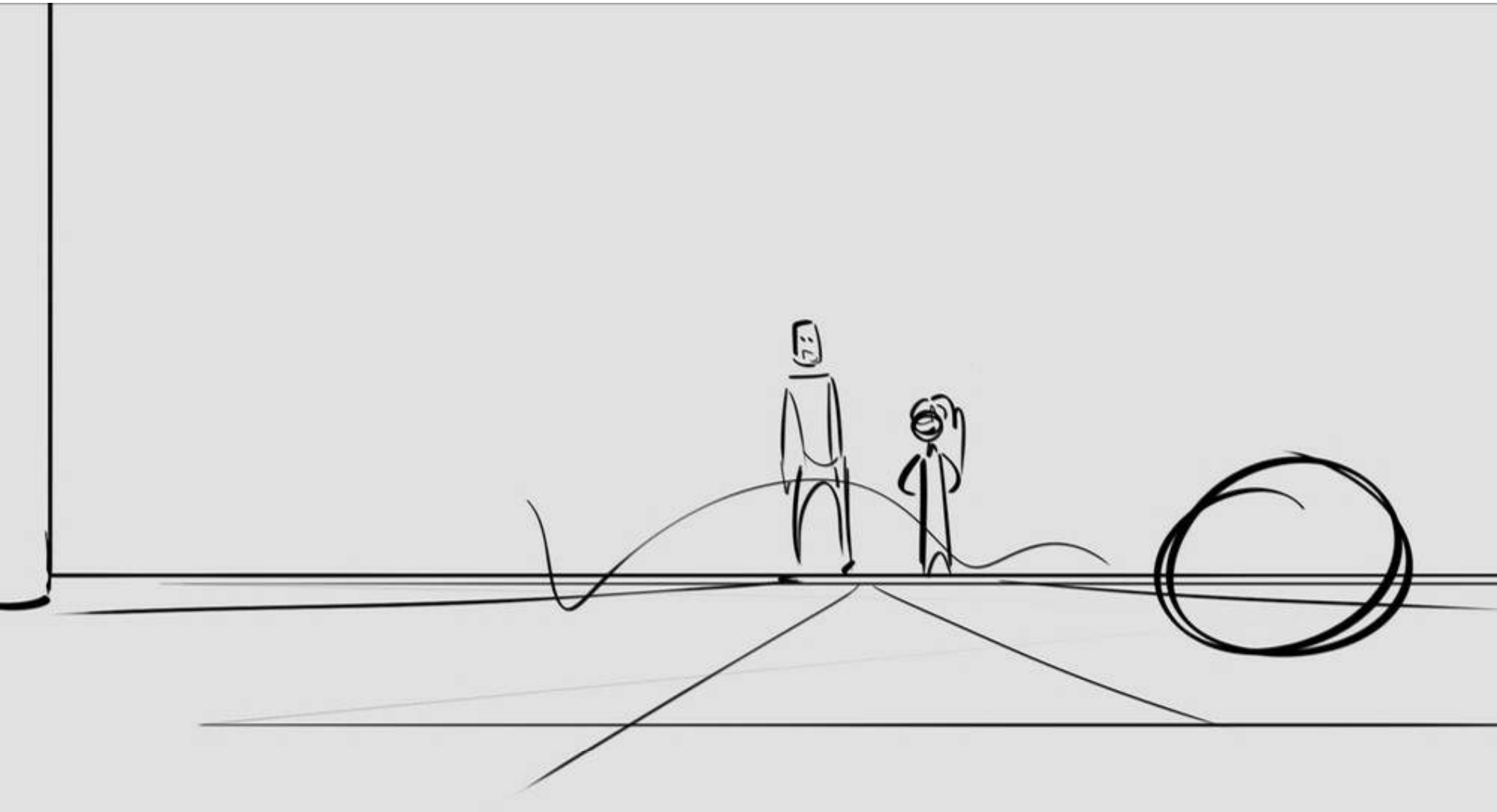

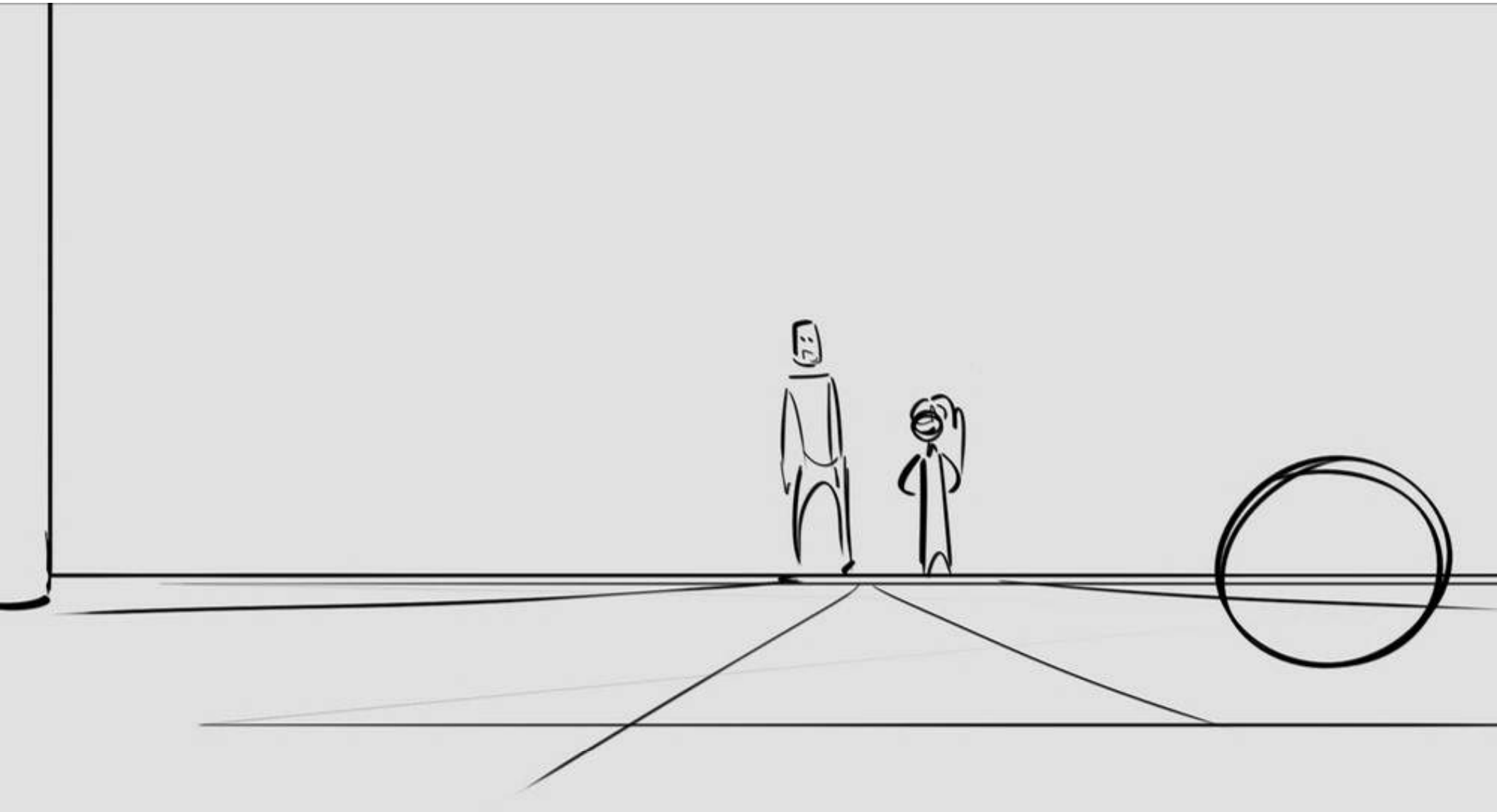



LOLA: So how exactly do sneaker endorsements work?





LEBRON: Uh-uh, you hit the backboard.